

CATALOG | OCTOBER 2021

Low voltage

General performance cast iron motors
for Europe

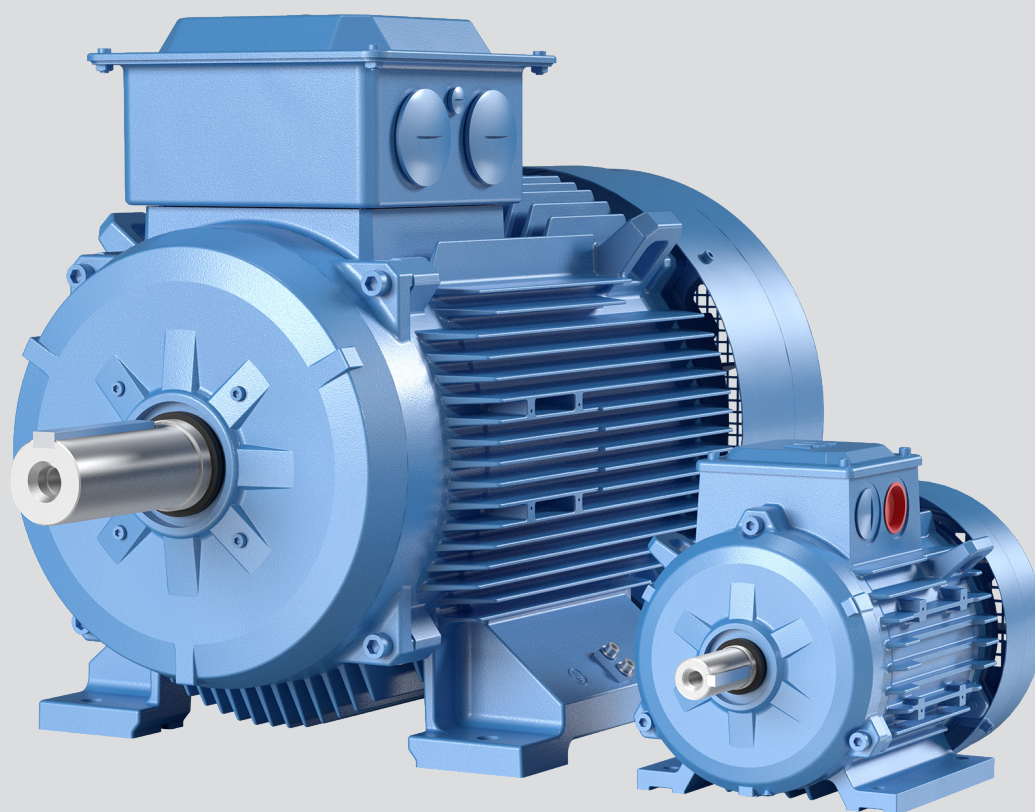

With expertise, and a comprehensive portfolio of products and life-cycle services, we help value-minded industrial customers improve their energy efficiency and productivity.

Low voltage General performance cast iron motors

Sizes 71 to 355, 0.18 to 355 kW

4	General information
7	Mounting arrangements
8	Cooling
9	Degrees of protection: IP code/IK code
10	Insulation
11	Voltage and frequency
12	Cast iron motors
12	Ordering information
13	Rating plates
14	Technical data IE3
17	Technical data IE2
20	Variant codes
22	Mechanical design
28	Dimension drawings IE3
29	Dimension drawings IE2
30	Motors in brief
34	Total product offering
35	ABB's portfolio of drives

International motor efficiency standards and regulations

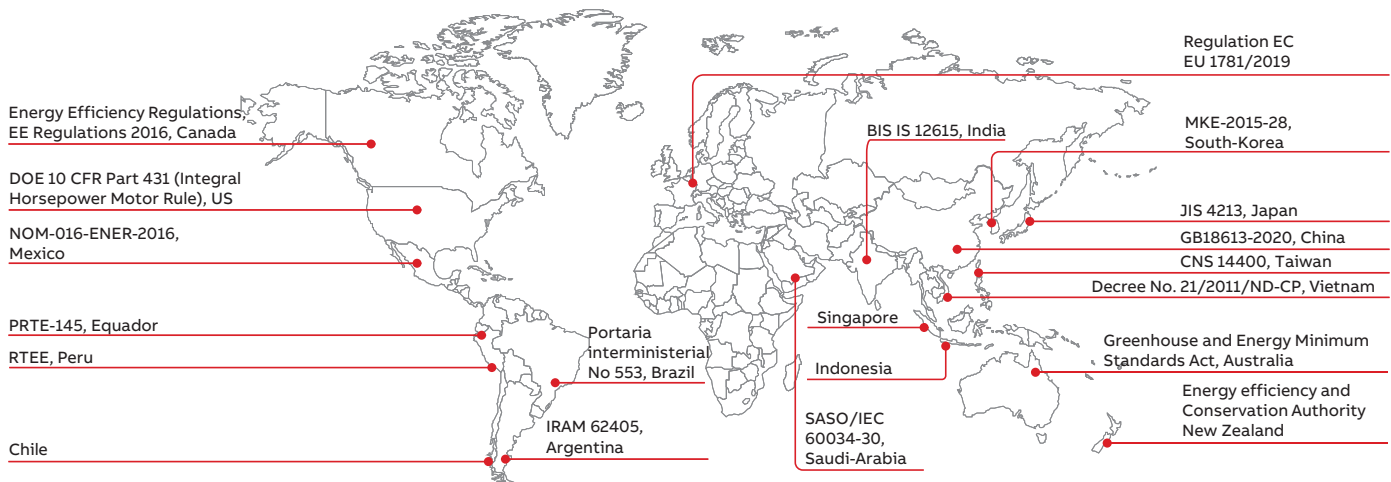

Since the validation of IEC 60034-30:2008 and its refined version IEC 60034-30-1:2014, a worldwide energy efficiency classification system has existed for low voltage three-phase asynchronous motors. These international standards have been created to enable and increase the level of harmonization in efficiency regulations around the world and to also cover motors for explosive atmospheres.

IEC 60034-30-1:2014 defines International Efficiency (IE) classes for single speed, three-phase, 50 Hz and 60 Hz induction motors. The efficiency levels defined in IEC 60034-30-1 are based on the test method specified in IEC 60034-2-1:2014. Both standards are part of an effort to unify motor testing procedures with CSA390-10 and IEEE 112 standards as well as efficiency and product labeling (IE) requirements to enable motor purchasers worldwide to easily recognize premium efficiency products.

To promote transparency in the market, IEC 60034-30-1 states that both the efficiency class and efficiency value must be shown on the motor rating plate and in product documentation. The documentation must clearly indicate the efficiency testing method used as different methods can produce differing results.

Minimum energy performance standards

While the IEC as an international standardization organization sets guidelines for motor testing and efficiency classes, the organization does not regulate efficiency levels in countries. The biggest drivers for mandatory Minimum Energy Performance Standard (MEPS) levels for electric motors are global climate change, government targets to curb CO₂ emissions and rising electricity demand, especially in developing countries. The whole value chain, from manufacturer up to end user, must be aware of the legislation in order to meet local requirements, to save energy and reduce the carbon footprint.

Harmonized global standards and the increasing adoption of MEPS around the world are good news for all of us. However, it is important to remember that harmonization is an ongoing process. Even though MEPS are already in effect in several regions and countries, they are evolving and differ in terms of scope and requirements. At the same time, more countries are planning to adopt their own MEPS regulations. A view of existing and coming MEPS regulations in the world can be seen on the World map above.

To get the latest information please visit www.abb.com/motors&generators/energyefficiency.

IEC 60034-30-1:2014

This standard defines four International Efficiency (IE) classes for single speed electric motors that are rated according to IEC 60034-1 or IEC 60079-0 (explosive atmospheres) and designed for operation on sinusoidal voltage.

- IE4 = Super premium efficiency
- IE3 = Premium efficiency, identical to the table in 10CFR431 ('NEMA Premium') in the USA and CSA C390-10:2015 for 60 Hz
- IE2 = High efficiency
- IE1 = Standard efficiency

IEC 60034-30-1 covers the power range from 0.12 kW up to 1000 kW. Most of the different technical constructions of electric motors are covered as long as they are rated for direct on-line operation. The coverage of the standard includes:

- Single speed electric motors (single and three-phase), 50 and 60 Hz
- 2, 4, 6 and 8 poles
- Rated output P_N from 0.12 kW to 1000 kW
- Rated voltage U_N above 50 V up to 1 kV
- Motors capable of continuous operation at their rated power with a temperature rise within the specified insulation temperature class
- Motors, marked with any ambient temperature within the range of -20 °C to +60 °C
- Motors, marked with an altitude up to 4000 m above sea level

By comparing IEC 60034-30-1 to CSA C390-10:2015 and "10CFR431 Subpart B – Electric motors", it can be seen that the efficiency limits and tables are well aligned and their major difference is in the scope of the output power where CSA and 10CFR431 have a maximum power of 500 hp. There are also some minor differences in the scope of excluded motors.

Note: CFR is Code of Federal Regulations.

The following motors are excluded from IEC 60034-30-1:

- Single-speed motors with 10 or more poles or multi-speed motors
- Motors completely integrated into a machine (for example pump, fan or compressor) that cannot be tested separately from the machine
- Brake motors, when the brake cannot be dismantled or separately fed

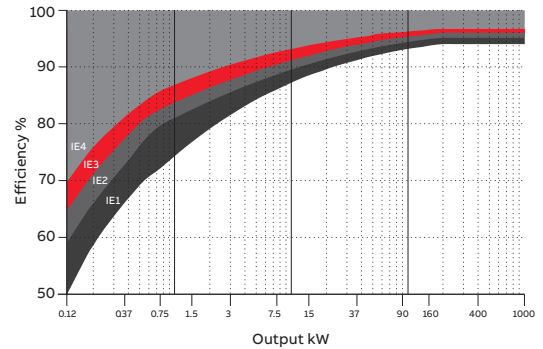

01

ABB and efficiency standards

ABB determines efficiency values according to IEC 60034-2-1 using the low uncertainty method (i.e. summation of losses), with additional load losses determined by the method of residual loss.

It is good to mention and emphasize that the IEC 60034-2-1 test method, which is known as an indirect method, is technically equivalent to the test methods in the standards CSA 390-10 and IEEE 112 Method B leading to the equivalent losses and thus efficiency values. Both test methods can be used by ABB and shall be used for both Canada and the US where IEC 60034-2-1 is not recognized yet.

As the world market leader, ABB offers the largest range of low voltage motors available. It has long advocated the need for efficiency in motors, and high efficiency products have formed the core of its portfolio for many years.

**Nominal efficiency limits defined in IEC
60034-30-1:2014 (reference values at 50 Hz,
based on test methods specified in IEC 60034-
2-1:2014).**

Output kW	IE1 Standard efficiency				IE2 High efficiency				IE3 Premium efficiency				IE4 Super Premium efficiency			
	2 pole	4 pole	6 pole	8 pole	2 pole	4 pole	6 pole	8 pole	2 pole	4 pole	6 pole	8 pole	2 pole	4 pole	6 pole	8 pole
0.12	45.0	50.0	38.3	31.0	53.6	59.1	50.6	39.8	60.8	64.8	57.7	50.7	66.5	69.8	64.9	62.3
0.18	52.8	57.0	45.5	38.0	60.4	64.7	56.6	45.9	65.9	69.9	63.9	58.7	70.8	74.7	70.1	67.2
0.20	54.6	58.5	47.6	39.7	61.9	65.9	58.2	47.4	67.2	71.1	65.4	60.6	71.9	75.8	71.4	68.4
0.25	58.2	61.5	52.1	43.4	64.8	68.5	61.6	50.6	69.7	73.5	68.6	64.1	74.3	77.9	74.1	70.8
0.37	63.9	66.0	59.7	49.7	69.5	72.7	67.6	56.1	73.8	77.3	73.5	69.3	78.1	81.1	78.0	74.3
0.40	64.9	66.8	61.1	50.9	70.4	73.5	68.8	57.2	74.6	78.0	74.4	70.1	78.9	81.7	78.7	74.9
0.55	69.0	70.0	65.8	56.1	74.1	77.1	73.1	61.7	77.8	80.8	77.2	73.0	81.5	83.9	80.9	77.0
0.75	72.1	72.1	70.0	61.2	77.4	79.6	75.9	66.2	80.7	82.5	78.9	75.0	83.5	85.7	82.7	78.4
1.1	75.0	75.0	72.9	66.5	79.6	81.4	78.1	70.8	82.7	84.1	81.0	77.7	85.2	87.2	84.5	80.8
1.5	77.2	77.2	75.2	70.2	81.3	82.8	79.8	74.1	84.2	85.3	82.5	79.7	86.5	88.2	85.9	82.6
2.2	79.7	79.7	77.7	74.2	83.2	84.3	81.8	77.6	85.9	86.7	84.3	81.9	88.0	89.5	87.4	84.5
3	81.5	81.5	79.7	77.0	84.6	85.5	83.3	80.0	87.1	87.7	85.6	83.5	89.1	90.4	88.6	85.9
4	83.1	83.1	81.4	79.2	85.8	86.6	84.6	81.9	88.1	88.6	86.8	84.8	90.0	91.1	89.5	87.1
5.5	84.7	84.7	83.1	81.4	87.0	87.7	86.0	83.8	89.2	89.6	88.0	86.2	90.9	91.9	90.5	88.3
7.5	86.0	86.0	84.7	83.1	88.1	88.7	87.2	85.3	90.1	90.4	89.1	87.3	91.7	92.6	91.3	89.3
11	87.6	87.6	86.4	85.0	89.4	89.8	88.7	86.9	91.2	91.4	90.3	88.6	92.6	93.3	92.3	90.4
15	88.7	88.7	87.7	86.2	90.3	90.6	89.7	88.0	91.9	92.1	91.2	89.6	93.3	93.9	92.9	91.2
18.5	89.3	89.3	88.6	86.9	90.9	91.2	90.4	88.6	92.4	92.6	91.7	90.1	93.7	94.2	93.4	91.7
22	89.9	89.9	89.2	87.4	91.3	91.6	90.9	89.1	92.7	93.0	92.2	90.6	94.0	94.5	93.7	92.1
30	90.7	90.7	90.2	88.3	92.0	92.3	91.7	89.8	93.3	93.6	92.9	91.3	94.5	94.9	94.2	92.7
37	91.2	91.2	90.8	88.8	92.5	92.7	92.2	90.3	93.7	93.9	93.3	91.8	94.8	95.2	94.5	93.1
45	91.7	91.7	91.4	89.2	92.9	93.1	92.7	90.7	94.0	94.2	93.7	92.2	95.0	95.4	94.8	93.4
55	92.1	92.1	91.9	89.7	93.2	93.5	93.1	91.0	94.3	94.6	94.1	92.5	95.3	95.7	95.1	93.7
75	92.7	92.7	92.6	90.3	93.8	94.0	93.7	91.6	94.7	95.0	94.6	93.1	95.6	96.0	95.4	94.2
90	93.0	93.0	92.9	90.7	94.1	94.2	94.0	91.9	95.0	95.2	94.9	93.4	95.8	96.1	95.6	94.4
110	93.3	93.3	93.3	91.1	94.3	94.5	94.3	92.3	95.2	95.4	95.1	93.7	96.0	96.3	95.8	94.7
132	93.5	93.5	93.5	91.5	94.6	94.7	94.6	92.6	95.4	95.6	95.4	94.0	96.2	96.4	96.0	94.9
160	93.8	93.8	93.8	91.9	94.8	94.9	94.8	93.0	95.6	95.8	95.6	94.3	96.3	96.6	96.2	95.1
200	94.0	94.0	94.0	92.5	95.0	95.1	95.0	93.5	95.8	96.0	95.8	94.6	96.5	96.7	96.3	95.4
250	94.0	94.0	94.0	92.5	95.0	95.1	95.0	93.5	95.8	96.0	95.8	94.6	96.5	96.7	96.5	95.4
315	94.0	94.0	94.0	92.5	95.0	95.1	95.0	93.5	95.8	96.0	95.8	94.6	96.5	96.7	96.6	95.4
355	94.0	94.0	94.0	92.5	95.0	95.1	95.0	93.5	95.8	96.0	95.8	94.6	96.5	96.7	96.6	95.4
400	94.0	94.0	94.0	92.5	95.0	95.1	95.0	93.5	95.8	96.0	95.8	94.6	96.5	96.7	96.6	95.4
450	94.0	94.0	94.0	92.5	95.0	95.1	95.0	93.5	95.8	96.0	95.8	94.6	96.5	96.7	96.6	95.4
500-1000	94.0	94.0	94.0	92.5	95.0	95.1	95.0	93.5	95.8	96.0	95.8	94.6	96.5	96.7	96.6	95.4

Mounting arrangements

Foot-mounted motor

Code I / code II

Product code pos. 12

A: foot-mounted, term. box top

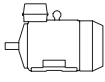
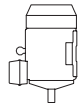
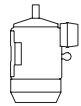
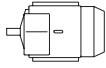
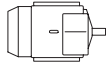
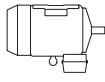
					
IM B3	IM V5	IM V6	IM B6	IM B7	IM B8
IM 1001	IM 1011	IM 1031	IM 1051	IM 1061	IM 1071

Flange-mounted motor, large flange

Code I / code II

Product code pos. 12

B: flange mounted, large flange

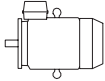
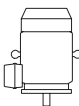
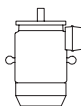
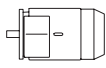
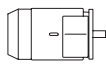
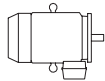
					
IM B5	IM V1	IM V3	*)	*)	*)
IM 3001	IM 3011	IM 3031	IM 3051	IM 3061	IM 3071

Flange-mounted motor, small flange

Code I / code II

Product code pos. 12

Small flange mounted motor IM B14 to be ordered as modification option, see variant code list.

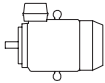
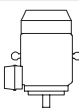
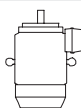
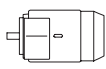
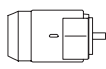
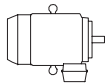
					
IM B14	IM V18	IM V19	*)	*)	*)
IM 3601	IM 3611	IM 3631	IM 3651	IM 3661	IM 3671

Foot- and flange-mounted motor with feet, large flange

Code I / code II

Product code pos. 12

Foot-flange mounted motor IM B35 to be ordered as modification option, see variant code list..

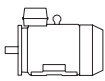
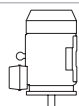
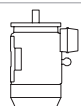
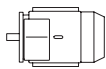
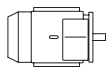
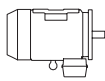
					
IM B35	IM V15	IM V35	*)	*)	*)
IM 2001	IM 2011	IM 2031	IM 2051	IM 2061	IM 2071

Foot- and flange-mounted motor with feet, small flange

Code I / code II

Product code pos. 12

Foot-flange mounted motor IMB34 o be ordered as modification option, see variant code list.

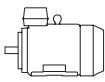
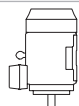
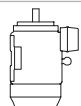
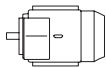
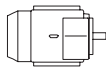
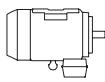
					
IM B34	IM V17				
IM 2101	IM 2111	IM 2131	IM 2151	IM 2161	IM 2171

*) Not stated in IEC 60034-7.

Note: If the motor is mounted shaft upwards, take measures to prevent water or any other liquid from running down the shaft into the motor.

General information

Cooling

Designation system concerning methods of cooling refers to standard IEC 60034-6.

Explanation of the product code

International Cooling	Circuit arrangement	Primary coolant	Method of movement of primary coolant	Secondary coolant	Method of movement of secondary coolant
IC	4	(A)	1	(A)	6
	1	2	3	4	5

Position 1

0: Free circulation (open circuit)

4: Free circulation (open circuit)

Position 2

A: For air (omitted for simplified designation)

Position 3

0: Free convection

1: Self-circulation

6: Machine-mounted independent component

Position 4

A: For air (omitted for simplified designation)

W: For water

Position 5

0: Free convection

1: Self-circulation

6: Machine-mounted independent component

8: Relative displacement

General information

Degrees of protection: IP code/IK code

Classification of degrees of protection provided by enclosures of rotating machines are refers to:

- Standard IEC 60034-5 or EN 60529 for IP code
- Standard EN 50102 for IK code

IP protection

Protection of persons against getting in contact with (or approaching) live parts and against contact with moving parts inside the enclosure. Also protection of the machine against ingress of solid foreign objects. Protection of machines against the harmful effects due to the ingress of water.

Explanation of the IP code

Ingress protection	Degree of protection to persons and to parts of the motors inside the enclosure	Degree of protection provided by the enclosure with respect to harmful effects due to ingress of water
IP	5	5
	1	2

Position 1

2:	Motors protected against solid objects greater than 12 mm
4:	Motors protected against solid objects greater than 1 mm
5:	Dust-protected motors
6:	Dust-tight motors

Position 2

3:	Motors protected against spraying water
4:	Motors protected against splashing water
5:	Motors protected against water jets
6:	Motors protected against heavy seas

IK code

Classification of degrees of protection provided by enclosure for motors against external mechanical impacts.

Explanation of the IK code

International mechanical protection	Characteristic group
IK	08
	1

Position 1

Relation between IK code and impact energy:

IK code	Impact energy/Joule
0:	Not protected according to EN 50102
01:	0.15
02:	0.2
03:	0.35
04:	0.5
05:	0.7
06:	1
07:	2
08:	5 (ABB Standard)
09:	10
10:	20

Insulation

01 Safety margins per thermal class.

ABB uses class F insulation, which, with temperature rise B, is the most common requirement among industry today.

The use of class F insulation with class B temperature rise gives ABB products a 25 °C safety margin. This can be used to increase the loading for limited periods, to operate at higher ambient temperatures or altitudes, or with greater voltage and frequency tolerances. It can also be used to extend insulation. For instance, a 10 K temperature reduction will extend the insulation life.

Thermal class 130 (B)

- Nominal ambient temperature 40 °C
- Max permissible temperature rise 80 K
- Hot spot temperature margin 10 K

Thermal class 155 (F)

- Nominal ambient temperature 40 °C
- Max permissible temperature rise 105 K
- Hot spot temperature margin 10 K

Thermal class 180 (H)

- Nominal ambient temperature 40 °C
- Max permissible temperature rise 125 K
- Hot spot temperature margin 10 K

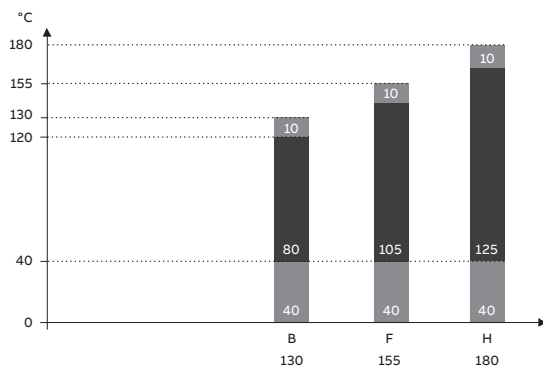

01

General information

Voltage and frequency

01 Voltage and frequency deviation in zones A and B.

The impact on temperature rise caused by voltage and frequency fluctuation is defined in IEC 60034-1. The standard divides the combinations into two zones, A and B. Zone A is the combination of voltage deviation of +/-5 % and frequency deviation of +/-2 %. Zone B is the combination of voltage deviation of +/-10 % and frequency deviation of +/-3 %. This is illustrated in figure below.

Motors are capable of supplying the rated torque in both zones A and B, but the temperature rise will be higher than at rated voltage and frequency. Motors can be run in zone B only for a short period of time.

Key	
X axis	frequency p.u.
Y axis	voltage p.u.
1	zone A
2	zone B (outside zone A)
3	rating point

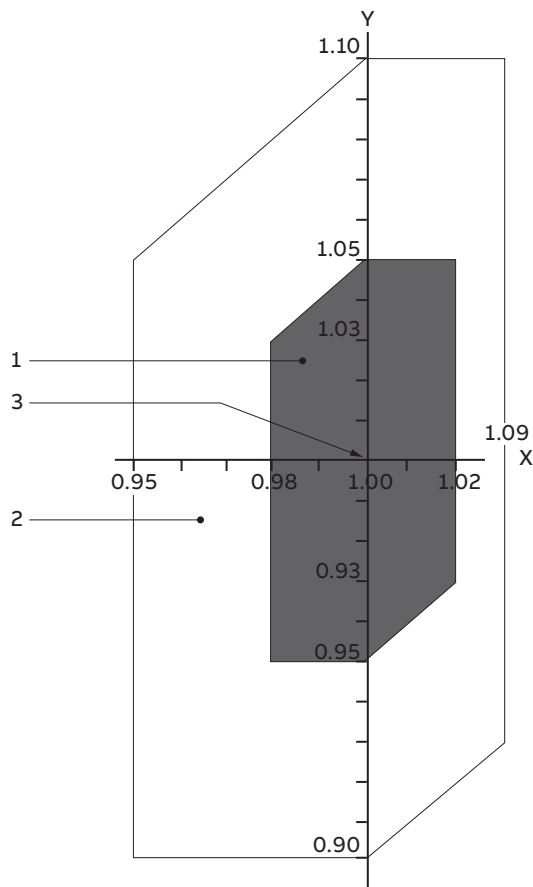

01

Ordering information

Explanation of the product code

Motor type	Motor size	Product code	Mounting arrangement code, Voltage and frequency code, Generation code	Variant codes
M2BAX	112MA	3GBA 112 310 - ADC		002, etc.
		1 2 3 4 5 6 7 8 9 10 11 12 13 14		

Positions 1 to 4

3GBA: Totally enclosed fan cooled squirrel cage motor with cast iron frame

Positions 5 and 6

IEC size

07:	71
08:	80
09:	90
10:	100
11:	112
13:	132
16:	160
18:	180
20:	200
22:	225
25:	250
28:	280
31:	315
35:	355

Position 7

Speed (Pole pairs)

1:	2 poles
2:	4 poles
3:	6 poles

Positions 8 to 10

Running number

Position 11

-(dash)

Position 12 (marked with black dot in data tables)

Mounting arrangement

A:	Foot-mounted, top-mounted terminal box
B:	Flange-mounted, large flange

Position 13 (marked with black dot in data tables)

Voltage and frequency

Single-speed motors

D:	400 VΔ, 690 VY, 380 VΔ, 660 VY, 50 Hz
S:	230 VΔ, 400 VY, 220 VΔ, 380 VY, 50 Hz

Position 14

A, B, C...= Generation code followed by variant codes

Efficiency values are given according to IEC 60034-2-1; 2014

For detailed dimension drawings please see our web-pages 'www.abb.com/motors&generators' or contact ABB.

Rating plates

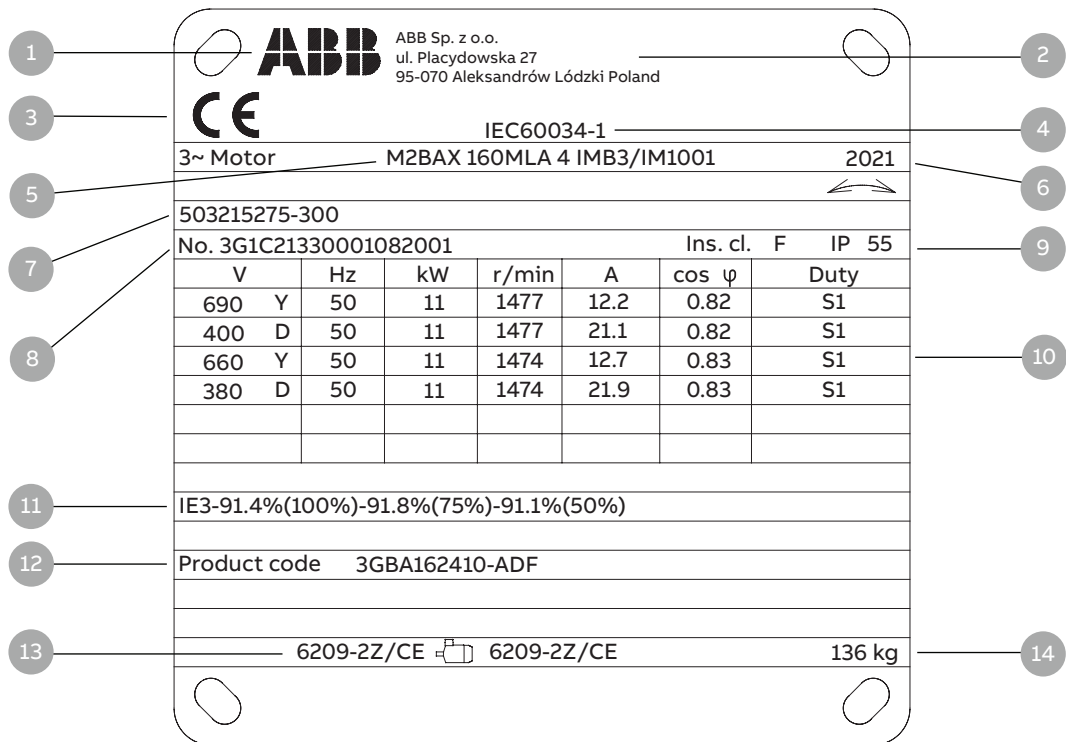

- 1 ABB logo
- 2 Manufacturing place
- 3 CE mark for fulfilling European Directives and Regulations
- 4 Manufacturing standard
- 5 Product description
- 6 Manufacturing year
- 7 Factory order reference number
- 8 Serial number
- 9 Insulation class, IP protection class
- 10 Voltage, Frequency, output, speed, current, power factory, duty
- 11 Efficiency class and efficiency 50 Hz at 100%, 75%, 50%; 60 Hz at 100%
- 12 Product code
- 13 Bearing type
- 14 Weight

Technical data

IE3 General performance cast iron motors

IP 55 - IC 411 - Insulation class F, temperature rise class B

IE3 efficiency class according to IEC 60034-30-1; 2014

Output kW	Motor type	Product code	Speed r/min	Efficiency IEC 60034-30-1; 2014			Power factor Cosφ	Current		Torque		Moment of inertia J = 1/4 GD ² kgm ²	Weight kg	Sound pressure Level L _{PA} dB	
				Full load 100%	3/4 load 75%	1/2 load 50%		I _N A	I _s /I _N	T _N Nm	T _i /T _N				T _b /T _N
3000 r/min = 2 poles				400 V 50 Hz				CENELEC-design							
0,37	M2BAX 71MC 2	3GBA071330---D	2819	76,5	76,0	73,4	0,8	0,86	6,6	1,26	2,7	3,2	0,00035	10	50
0,55	M2BAX 71MB 2	3GBA071320---D	2816	78,4	78,1	75,9	0,8	1,27	6,1	1,88	2,7	3,2	0,0004	10	49
0,75	M2BAX 80MC 2	3GBA081330---D	2891	80,7	81,0	78,9	0,8	1,66	7,5	2,49	2,9	3,7	0,00081	16	58
1,1	M2BAX 80MD 2	3GBA081340---D	2860	82,7	83,3	82,6	0,84	2,29	7,6	3,7	3,2	3,6	0,00102	17	60
1,5	M2BAX 90SB 2	3GBA091120---D	2912	84,2	84,0	82,5	0,83	3,04	8,6	4,96	2,8	3,9	0,00234	23	54
2,2	M2BAX90SLA 2	3GBA091010---D	2908	85,9	85,6	83,9	0,81	4,54	8,8	7,26	3,2	3,9	0,003	26	67
3	M2BAX 100LKA 2	3GBA101810---D	2910	87,1	88,0	88,0	0,91	5,38	8,9	9,84	3,0	3,8	0,00691	42	60
4	M2BAX 112MB 2	3GBA111320---D	2908	88,1	89,0	89,1	0,91	7,2	9,7	13,14	3,0	3,8	0,00711	42	64
5,5	M2BAX 132SMA 2	3GBA131210---D	2931	89,2	89,8	89,2	0,83	10,5	8,6	17,92	2,4	4,0	0,0136	64	65
7,5	M2BAX 132SMB 2	3GBA131220---D	2921	90,1	91,0	90,9	0,84	14	9,0	24,5	2,6	4,0	0,0166	72	65
11	M2BAX 160MLA 2	3GBA161410---F	2943	91,2	92,0	91,6	0,91	19,1	7,2	35,57	2,6	3,6	0,057	121	69
15	M2BAX 160MLB 2	3GBA161420---F	2947	91,9	92,2	91,8	0,88	26,5	8,2	48,49	3,2	4,2	0,063	128	69
18,5	M2BAX 160MLC 2	3GBA161430---F	2949	92,4	93,0	92,6	0,9	32	9,0	59,81	3,3	3,9	0,076	145	73
22	M2BAX 180MLA 2	3GBA181410---F	2941	92,7	93,0	92,7	0,84	41,1	8,7	71,42	3,4	4,1	0,073	152	70
30	M2BAX 200MLA 2	3GBA201410---F	2961	93,3	93,3	92,6	0,89	52	10,0	96,89	3,7	4,1	0,144	250	80
37	M2BAX 200MLB 2	3GBA201420---F	2951	93,7	93,9	93,3	0,89	63,9	10,5	119	4,2	4,1	0,16	268	78
45	M2BAX 225SMA 2	3GBA221210---F	2962	94,0	94,0	93,3	0,85	81,3	9,3	145	3,8	4,1	0,223	278	80
55	M2BAX 250SMA 2	3GBA251210---F	2965	94,3	94,3	93,7	0,87	96,4	7,4	177	3,4	3,0	0,344	335	78
75	M2BAX 280SMF 2	3GBA281260---F	2971	94,7	94,7	94,0	0,89	129	7,7	241	2,7	3,3	0,6	527	78
90	M2BAX 280SMG 2	3GBA281270---F	2970	95,0	95,3	95,2	0,91	152	8,0	289	3,1	3,3	0,7	576	76
110	M2BAX 315SMB 2	3GBA311220---M	2982	95,2	94,9	93,9	0,87	192	7,0	352	1,8	2,7	1,3	801	78
132	M2BAX 315SMC 2	3GBA311230---M	2982	95,4	95,4	94,6	0,87	229	6,8	422	2,0	2,8	1,5	852	78
160	M2BAX 315SMD 2	3GBA311240---M	2983	95,6	95,6	94,9	0,87	275	7,4	512	2,2	2,8	1,7	909	78
200	¹⁾ M2BAX 315MLA 2	3GBA311410---M	2983	95,8	96,0	95,5	0,88	342	7,5	640	2,3	3,1	2,1	1051	81
250	M2BAX 355SMA 2	3GBA351210---M	2985	95,8	95,6	94,6	0,89	423	7,7	800	2,1	3,3	3	1412	83
315	M2BAX 355SMB 2	3GBA351220---M	2980	95,8	95,7	95,0	0,89	529	7,0	1009	2,1	3,0	3,4	1495	83
355	M2BAX 355SMC 2	3GBA351230---M	2984	95,8	95,8	95,0	0,88	605	7,2	1136	2,2	3	3,6	1565	83

¹⁾ Temperature rise class F

Technical data

IE3 General performance cast iron motors

IP 55 - IC 411 - Insulation class F, temperature rise class B

IE3 efficiency class according to IEC 60034-30-1; 2014

Output kW	Motor type	Product code	Speed r/min	Efficiency IEC 60034-30-1; 2014			Power factor Cosφ	Current		Torque		Moment of inertia J = 1/4 GD ² kgm ²	Weight kg	Sound pressure Level L _{PA} dB	
				Full load 100%	3/4 load 75%	1/2 load 50%		I _N A	I _s /I _N	T _N Nm	T _i /T _N				T _b /T _N
1500 r/min = 4 poles				400 V 50 Hz				CENELEC-design							
0,25	M2BAX 71MB 4	3GBA072320---D	1440	73,5	70,1	63,8	0,64	0,78	6,1	1,67	2,7	3,5	0,00075	10	41
0,37	M2BAX 71MLA 4	3GBA072410---D	1441	77,3	74,9	69,8	0,66	1,06	6,8	2,47	2,7	3,8	0,00098	12	50
0,55	M2BAX 80MC 4	3GBA082330---D	1446	80,8	80,7	78,0	0,74	1,32	8,4	3,64	2,7	3,9	0,00228	17	48
0,75	M2BAX 80MLA 4	3GBA082410---D	1445	82,5	81,2	77,6	0,7	1,84	8,2	4,88	3,8	4,6	0,00295	21	49
1,1	M2BAX 90SB 4	3GBA092120---D	1438	84,1	83,4	80,9	0,73	2,59	7,9	7,28	3,6	4,2	0,00394	23	48
1,5	M2BAX 90SLA 4	3GBA092010---D	1434	85,3	84,4	82,1	0,73	3,52	7,9	9,95	3,9	4,0	0,00485	25	44
2,2	M2BAX 100LB 4	3GBA102520---D	1450	86,7	86,1	84,1	0,78	4,74	9,3	14,53	3,4	4,4	0,00863	34	50
3	M2BAX 100LKA 4	3GBA102810---D	1448	87,7	87,7	86,5	0,79	6,25	9,6	19,86	3,6	4,5	0,0115	41	57
4	M2BAX 112MLA 4	3GBA112410---D	1443	88,6	89,6	89,4	0,82	7,91	9,5	26,59	3,6	4,3	0,0152	50	56
5,5	M2BAX 132SMA 4	3GBA132210---D	1463	89,6	90,5	90,3	0,77	11,4	7,9	35,9	2,6	3,3	0,0297	67	68
7,5	M2BAX 132MLA 4	3GBA132410---D	1456	90,4	91,1	90,8	0,78	15,2	8,8	49,1	2,5	3,0	0,039	84	65
11	M2BAX 160MLA 4	3GBA162410---F	1477	91,4	91,8	91,1	0,82	21,1	7,6	71,27	2,6	3,3	0,11	136	61
15	M2BAX 160MLB 4	3GBA162420---F	1477	92,1	92,4	91,6	0,82	28,5	8,2	96,99	3,0	3,7	0,135	161	61
18,5	M2BAX 180MLA 4	3GBA182410---F	1472	92,6	92,6	92,0	0,82	35	10,3	120	3,6	4,0	0,135	169	64
22	M2BAX 180MLB 4	3GBA182420---F	1473	93,0	93,2	92,5	0,8	42,8	10,1	143	3,3	4,2	0,167	198	65
30	M2BAX 200MLA 4	3GBA202410---F	1481	93,6	94,0	93,5	0,82	56,3	10,0	193	3,9	3,0	0,32	282	69
37	M2BAX 225SMA 4	3GBA222210---F	1479	93,9	94,2	93,7	0,81	70,3	9,3	238	2,5	3,0	0,376	278	67
45	M2BAX 225SMB 4	3GBA222220---F	1481	94,2	94,4	93,8	0,79	87,8	9,1	288	4,2	3,6	0,415	293	68
55	M2BAX 250SMA 4	3GBA252210---F	1479	94,6	94,7	94,0	0,83	102	10,1	352	4,4	3,4	0,62	386	74
75	M2BAX 280SMF 4	3GBA282260---F	1481	95,0	95,1	95,0	0,83	137	8,6	484	3,6	3,8	0,959	530	68
90	M2BAX 280SMG 4	3GBA282270---F	1482	95,2	95,3	95,2	0,85	161	8,4	580	3,8	3,9	1,17	593	68
110	M2BAX 315SMB 4	3GBA312220---M	1489	95,4	95,4	94,8	0,85	196	7,0	705	2,1	3,0	2,43	823	71
132	M2BAX 315SMC 4	3GBA312230---M	1488	95,6	95,8	95,3	0,86	231	6,7	847	2,2	2,9	2,9	892	71
160	M2BAX 315SMD 4	3GBA312240---M	1488	95,8	96,0	95,8	0,85	282	6,9	1026	2,2	3,0	3,2	933	71
200	M2BAX 315MLB 4	3GBA312420---M	1487	96,0	96,4	96,4	0,86	351	6,8	1284	2,4	3,0	3,9	1091	74
250	M2BAX 355SMA 4	3GBA352210---M	1491	96,0	96,0	95,6	0,86	435	6,4	1601	2,1	2,9	5,9	1445	78
315	M2BAX 355SMB 4	3GBA352220---M	1491	96,0	96,0	95,6	0,86	545	6,7	2018	2,3	3,0	6,9	1595	78
355	M2BAX 355SMC 4	3GBA352230---M	1490	96,0	96,2	95,8	0,86	616	6,3	2273	2,3	2,8	7,2	1635	78

Technical data

IE3 General performance cast iron motors

IP 55 - IC 411 - Insulation class F, temperature rise class B

IE3 efficiency class according to IEC 60034-30-1; 2014

Output kW	Motor type	Product code	Speed r/min	Efficiency IEC 60034-30-1; 2014			Power factor Cosφ	Current			Torque		Moment of inertia J = 1/4 GD ² kgm ²	Weight kg	Sound pressure Level L _{PA} dB
				Full load 100%	3/4 load 75%	1/2 load 50%		I _N A	I _s /I _N	T _N Nm	T _i /T _N	T _b /T _N			
1000 r/min = 6 poles				400 V 50 Hz				CENELEC-design							
0,18	M2BAX 71MB 6	3GBA073320...D	931	63,9	60,0	53,2	0,69	0,6	3,8	1,87	2,1	2,6	0,00103	10	39
0,25	M2BAX 71MLA 6	3GBA073410...D	926	68,6	66,3	60,9	0,67	0,8	4,3	2,58	2,6	2,9	0,0014	13	46
0,37	M2BAX 80MC 6	3GBA083330...D	939	73,5	71,5	66,7	0,66	1,09	5,6	3,8	2,8	3,2	0,0024	17	42
0,55	M2BAX 80MLA 6	3GBA083410...D	943	77,2	75,9	71,9	0,68	1,54	6,3	5,6	3,4	3,5	0,00353	23	48
0,75	M2BAX 90SLA 6	3GBA093010...D	952	78,9	78,0	73,9	0,59	2,35	5,3	7,52	3,1	3,6	0,0044	23	50
1,1	M2BAX 90LB 6	3GBA093520...D	954	81,0	80,3	75,5	0,62	3,2	6,1	11,12	3,3	3,9	0,00643	30	53
1,5	M2BAX 100LKA 6	3GBA103810...D	953	82,5	82,1	80,0	0,66	4,0	5,3	15,11	2,7	3,0	0,00975	37	48
2,2	M2BAX 112MLA 6	3GBA113410...D	957	84,3	83,8	81,5	0,64	5,94	6,5	21,95	2,9	3,7	0,013	46	50
3	M2BAX 132SMA 6	3GBA133210...D	968	85,6	86,1	84,9	0,68	7,4	6,7	29,59	2,1	3,2	0,0291	65	48
4	M2BAX 132SMB 6	3GBA133220...D	972	86,8	86,8	84,9	0,65	10,1	7,0	39,3	2,7	3,6	0,0343	71	52
5,5	M2BAX 132MLA 6	3GBA133410...D	974	88,0	87,4	86,0	0,67	13,5	7,3	54,2	2,9	3,5	0,0511	97	65
7,5	M2BAX 160MLA 6	3GBA163410...F	979	89,1	89,5	88,9	0,75	15,9	7,6	73,39	1,8	3,1	0,099	131	59
11	M2BAX 160MLB 6	3GBA163420...F	976	90,3	91,3	91,3	0,78	22,5	7,8	108	1,9	3,0	0,134	161	57
15	M2BAX 180MLA 6	3GBA183410...F	971	91,2	91,8	91,2	0,75	31,8	9,4	146	2,3	3,6	0,162	197	63
18,5	M2BAX 200MLA 6	3GBA203410...F	978	91,7	92,1	91,5	0,75	38,8	6,7	180	2,1	2,8	0,207	208	64
22	M2BAX 200MLB 6	3GBA203420...F	978	92,2	92,5	91,8	0,75	45,9	7,3	214	2,3	3,0	0,255	251	62
30	M2BAX 225SMA 6	3GBA223210...F	988	92,9	93,3	92,7	0,79	59	8,2	290	2,9	3,3	0,592	286	63
37	M2BAX 250SMA 6	3GBA253210...F	986	93,3	93,6	93,1	0,79	72,4	8,5	353	3,3	3,0	0,83	360	64
45	M2BAX 280SMF 6	3GBA283260...F	990	93,7	93,9	93,5	0,82	84,5	8,0	434	3,2	2,9	1,6	524	62
55	M2BAX 280SMG 6	3GBA283270...F	989	94,1	94,5	94,2	0,82	103	8,6	531	3,4	2,9	1,8	563	64
75	M2BAX 315SMB 6	3GBA313220...M	994	94,6	94,9	94,6	0,84	136	6,8	720	1,8	2,6	4,1	791	75
90	M2BAX 315SMC 6	3GBA313230...M	994	94,9	95,1	94,7	0,84	164	7,2	864	2,0	3,0	4,6	859	76
110	M2BAX 315SMD 6	3GBA313240...M	994	95,1	95,3	95,0	0,83	200	7,3	1056	2,2	3,1	4,9	912	75
132	M2BAX 315MLB 6	3GBA313420...M	995	95,4	95,5	95,1	0,82	242	7,3	1266	2,3	3,2	6,3	1068	72
160	M2BAX 355SMA 6	3GBA353210...M	993	95,6	95,9	95,6	0,82	292	6,7	1538	2,5	2,6	7,9	1348	75
200	M2BAX 355SMB 6	3GBA353220...M	993	95,8	96,2	96,1	0,82	365	6,7	1923	2,6	2,5	9,7	1512	75
250	M2BAX 355SMC 6	3GBA353230...M	993	95,8	96,1	95,8	0,81	464	7,7	2404	3,0	3,1	11,3	1656	75

Technical data

IE2 General performance cast iron motors

IP 55 - IC 411 - Insulation class F, temperature rise class B
IE2 efficiency class according to IEC 60034-30-1; 2014

Output kW	Motor type	Product code	Speed r/min	Efficiency IEC 60034-30-1; 2014			Power factor Cosφ	Current			Torque		Moment of inertia J = 1/4 GD ² kgm ²	Weight kg	Sound pressure Level L _{PA} dB
				Full load 100%	3/4 load 75%	1/2 load 50%		I _N A	I _s /I _N	T _N Nm	T _i /T _N	T _b /T _N			
3000 r/min = 2 poles				400 V 50 Hz				CENELEC-design							
0,37	M2BAX 71MA 2	3GBA071310---C	2797	69,5	67,4	62,7	0,78	0,91	5,3	1,24	2,9	3,6	0,00033	9	56
0,55	M2BAX 71MB 2	3GBA071320---C	2811	74,1	72,8	69,5	0,79	1,3	5,4	1,85	3,0	3,5	0,00041	10	58
0,75	M2BAX 80MA 2	3GBA081310---C	2843	77,4	76,3	73,7	0,81	1,71	6,2	2,51	2,9	4,3	0,00067	14	63
1,1	M2BAX 80MB 2	3GBA081320---C	2840	79,6	79,5	77,6	0,83	2,44	6,0	3,67	3,1	3,8	0,0009	15	62
1,5	M2BAX 90SA 2	3GBA091110---C	2887	81,3	79,9	77,1	0,79	3,37	6,5	4,93	3,0	3,9	0,0021	21	66
2,2	M2BAX 90LA 2	3GBA091510---C	2894	83,2	83,0	81,4	0,84	4,48	7,7	7,25	3,1	3,8	0,0027	24	67
3	M2BAX 100LA 2	3GBA101510---C	2919	84,6	83,6	81,3	0,84	6,12	8,7	9,81	4,1	5,0	0,0048	32	74
4	M2BAX 112MA 2	3GBA111310---C	2916	85,8	85,3	83,1	0,86	7,89	9,1	13,08	4,1	4,7	0,00561	36	74
5,5	M2BAX 132SA 2	3GBA131110---C	2921	87,0	86,0	83,7	0,85	10,8	8,3	18,02	2,6	4,3	0,0117	56	74
7,5	M2BAX 132SB 2	3GBA131120---C	2916	88,1	87,5	85,7	0,84	14,5	8,7	24,57	3,1	4,5	0,0132	60	72
11	M2BAX 160MLA 2	3GBA161410---C	2931	89,4	89,4	88,3	0,86	20,7	6,6	35,87	2,5	3,5	0,041	103	72
15	M2BAX 160MLB 2	3GBA161420---C	2938	90,3	90,5	89,8	0,88	27	7,6	48,89	3,1	3,5	0,0538	116	72
18,5	M2BAX 160MLC 2	3GBA161430---C	2939	90,9	91,0	90,3	0,87	33,4	7,9	60,1	3,1	3,8	0,06	124	73
22	M2BAX 180MLA 2	3GBA181410---C	2943	91,3	91,6	90,9	0,87	39,5	8,6	71,4	3,7	3,9	0,0735	151	72
30	M2BAX 200MLA 2	3GBA201410---C	2957	92,0	91,5	90,1	0,85	55,8	8,6	97,1	4,0	4,2	0,11	198	81
37	M2BAX 200MLB 2	3GBA201420---C	2951	92,5	92,5	92,2	0,90	64,2	7,9	120	3,6	3,7	0,141	229	80
45	M2BAX 225SMA 2	3GBA221210---C	2962	92,9	92,8	92,1	0,86	80,6	8,8	145	3,8	3,8	0,226	275	82
55	M2BAX 250SMA 2	3GBA251210---C	2965	93,2	93,2	92,5	0,87	97,9	7,4	177	3,4	3,0	0,344	335	78
75	M2BAX 280SMD 2	3GBA281240---H	2971	93,8	94,0	93,9	0,89	129	7,7	241	2,7	3,3	0,6	527	78
90	M2BAX 280SME 2	3GBA281250---H	2970	94,1	94,3	94,2	0,91	152	8,0	289	3,1	3,3	0,7	576	76
110	M2BAX 315SMA 2	3GBA311210---H	2979	94,3	94,2	93,1	0,90	187	7,6	353	2,5	3,2	0,95	790	78
132	M2BAX 315SMB 2	3GBA311220---H	2977	94,6	94,6	93,7	0,90	224	7,7	423	2,7	3,1	1,4	840	78
160	M2BAX 315SMC 2	3GBA311230---H	2976	94,8	95,0	94,4	0,90	269	7,7	513	2,8	3,0	1,7	900	78
200	M2BAX 315MLA 2	3GBA311410---C	2979	95,0	94,8	93,9	0,89	341	7,2	641	2,4	3,6	2,1	1037	83
250	M2BAX 355SMA 2	3GBA351210---C	2983	95,0	94,7	93,7	0,89	428	6,7	800	1,5	2,8	2,7	1329	83
315	M2BAX 355SMB 2	3GBA351220---C	2980	95,0	95,0	94,2	0,89	537	7,2	1009	1,9	2,8	3,4	1469	83
355	M2BAX 355SMC 2	3GBA351230---C	2983	95,0	95,0	94,3	0,88	609	7,4	1136	2,1	2,7	3,6	1539	83

Technical data

IE2 General performance cast iron motors

IP 55 - IC 411 - Insulation class F, temperature rise class B
IE2 efficiency class according to IEC 60034-30-1; 2014

Output kW	Motor type	Product code	Speed r/min	Efficiency IEC 60034-30-1; 2014			Power factor Cosφ	Current		Torque		Moment of inertia J = 1/4 GD ² kgm ²	Weight kg	Sound pressure Level L _{PA} dB	
				Full load 100%	3/4 load 75%	1/2 load 50%		I _N A	I _s /I _N	T _N Nm	T _i /T _N				T _b /T _N
1500 r/min = 4 poles				400 V 50 Hz				CENELEC-design							
0,25	M2BAX 71MA 4	3GBA072310---C	1424	68,5	65,1	58,6	0,70	0,74	4,6	1,68	2,0	2,9	0,0006	9	49
0,37	M2BAX 71MB 4	3GBA072320---C	1417	72,7	71,6	66,6	0,72	1,03	4,9	2,49	2,5	3,1	0,00076	10	46
0,55	M2BAX 80MA 4	3GBA082310---C	1431	77,1	77,4	74,9	0,77	1,34	5,8	3,67	2,7	3,2	0,0022	15	50
0,75	M2BAX 80MB 4	3GBA082320---C	1446	79,6	78,8	74,9	0,69	1,99	6,6	4,97	3,7	3,9	0,00247	18	53
1,1	M2BAX 90SA 4	3GBA092110---C	1447	81,4	79,6	75,6	0,71	2,74	6,6	7,35	3,9	4,3	0,0037	22	51
1,5	M2BAX 90LA 4	3GBA092510---C	1444	82,8	83,1	81,3	0,73	3,6	6,8	10	3,7	4,2	0,0046	24	55
2,2	M2BAX 100LA 4	3GBA102510---C	1445	84,3	83,8	81,5	0,77	4,93	7,3	14,54	3,2	3,9	0,00759	31	55
3	M2BAX 100LB 4	3GBA102520---C	1443	85,5	85,2	83,4	0,77	6,61	7,6	19,8	3,8	4,3	0,00939	35	58
4	M2BAX 112MA 4	3GBA112310---C	1442	86,6	86,2	84,6	0,78	8,62	7,5	26,5	4,0	4,3	0,012	41	56
5,5	M2BAX 132SA 4	3GBA132110---C	1457	87,7	87,5	86,2	0,77	11,7	6,9	36	2,5	3,4	0,0257	59	65
7,5	M2BAX 132MA 4	3GBA132310---C	1457	88,7	88,6	87,4	0,77	16	7,2	49,1	2,6	3,6	0,0319	70	67
11	M2BAX 160MLA 4	3GBA162410---C	1466	89,8	89,9	89,2	0,78	22,8	7,0	71,5	3,3	3,2	0,078	111	66
15	M2BAX 160MLB 4	3GBA162420---C	1468	90,6	91,1	90,5	0,81	29,5	8,0	97,7	3,2	3,7	0,1	126	66
18,5	M2BAX 180MLA 4	3GBA182410---C	1470	91,2	91,4	90,5	0,79	36,9	8,5	120	3,6	4,2	0,12	156	65
22	M2BAX 180MLB 4	3GBA182420---C	1472	91,6	91,3	90,2	0,77	45	9,2	143	4,1	4,5	0,139	169	66
30	M2BAX 200MLA 4	3GBA202410---C	1476	92,3	92,4	92,0	0,81	58,4	6,8	194	3,0	3,2	0,236	222	68
37	M2BAX 225SMA 4	3GBA222210---C	1479	92,7	92,7	92,2	0,81	70,6	7,4	239	3,1	3,3	0,35	265	69
45	M2BAX 225SMB 4	3GBA222220---C	1481	93,1	92,9	92,3	0,80	87,2	7,9	290	3,4	3,4	0,416	292	69
75	M2BAX 280SMD 4	3GBA282240---H	1480	94,0	94,1	93,8	0,83	138	8,4	484	3,3	3,5	0,9	520	70
90	M2BAX 280SME 4	3GBA282250---H	1480	94,2	94,3	94,0	0,86	160	7,8	581	3,3	3,4	1,1	583	70
110	M2BAX 315SMA 4	3GBA312210---H	1485	94,5	94,8	94,4	0,85	195	7,2	707	2,9	3,0	2,3	750	68
132	M2BAX 315SMB 4	3GBA312220---H	1484	94,7	95,0	94,7	0,88	228	7,3	849	3,0	2,9	2,6	855	68
160	M2BAX 315SMC 4	3GBA312230---H	1484	94,9	95,1	94,7	0,85	283	7,5	1030	3,4	3,1	2,9	900	68
200	M2BAX 315MLA 4	3GBA312410---C	1486	95,1	95,2	94,6	0,86	356	7,0	1285	2,3	2,8	3,5	1012	78
250	M2BAX 355SMA 4	3GBA352210---C	1488	95,1	95,1	94,2	0,85	445	6,7	1604	2,0	2,6	5,4	1419	82
315	M2BAX 355SMB 4	3GBA352220---C	1488	95,1	95,1	94,3	0,85	560	7,3	2021	2,2	2,7	6,9	1589	82
355	M2BAX 355SMC 4	3GBA352230---C	1487	95,1	95,3	94,7	0,86	623	6,8	2279	2,4	2,7	7,2	1669	82
355	M2BAX 355SMC 4	3GBA352230---C	1487	95,1	95,3	94,7	0,86	623	6,8	2279	2,4	2,7	7,2	1650	82

Technical data

IE2 General performance cast iron motors

IP 55 - IC 411 - Insulation class F, temperature rise class B

IE2 efficiency class according to IEC 60034-30-1; 2014

Output kW	Motor type	Product code	Speed r/min	Efficiency IEC 60034-30-1; 2014			Power factor Cosφ	Current		Torque		Moment of inertia J = 1/4 GD ² kgm ²	Weight kg	Sound pressure Level L _{PA} dB	
				Full load 100%	3/4 load 75%	1/2 load 50%		I _N A	I _s /I _N	T _N Nm	T _i /T _N				T _b /T _N
1000 r/min = 6 poles				400 V 50 Hz				CENELEC-design							
0,18	M2BAX 71MA 6	3GBA073310...C	905	56,6	52,3	45,2	0,72	0,64	3,5	1,84	2,2	2,6	0,00082	9	40
0,25	M2BAX 71MB 6	3GBA073320...C	920	61,6	57,1	50,0	0,71	0,83	3,8	2,56	2,6	3,0	0,00105	10	47
0,37	M2BAX 80MA 6	3GBA083310...C	936	67,6	66,0	60,3	0,68	1,16	4,3	3,77	2,6	3,0	0,00185	14	47
0,55	M2BAX 80MB 6	3GBA083320...C	932	73,1	71,1	66,5	0,65	1,67	4,7	5,61	3,0	3,1	0,00267	19	47
0,75	M2BAX 90SA 6	3GBA093110...C	951	75,9	73,3	68,2	0,60	2,36	4,9	7,6	3,3	3,7	0,0044	22	50
1,1	M2BAX 90LA 6	3GBA093510...C	936	78,1	76,5	73,0	0,65	3,17	4,6	11,06	3,0	3,3	0,0051	25	48
1,5	M2BAX 100LA 6	3GBA103510...C	957	79,8	78,1	74,0	0,63	4,36	5,7	15	2,6	3,3	0,00795	31	56
2,2	M2BAX 112MA 6	3GBA113310...C	956	81,8	80,4	77,6	0,66	5,92	5,5	21,9	2,8	3,5	0,0116	40	54
3	M2BAX 132SA 6	3GBA133110...C	966	83,3	82,6	80,8	0,64	8,09	5,6	29,43	1,9	3,0	0,0251	57	62
4	M2BAX 132MA 6	3GBA133310...C	964	84,6	84,3	82,7	0,69	9,95	6,4	39,76	2,7	3,3	0,0294	65	59
5,5	M2BAX 132MB 6	3GBA133320...C	964	86,0	85,9	84,6	0,66	14	5,8	54,2	2,2	2,9	0,0397	79	62
7,5	M2BAX 160MLA 6	3GBA163410...C	974	87,2	87,5	86,9	0,74	16,4	6,6	73,7	2,0	3,2	0,0811	114	65
11	M2BAX 160MLB 6	3GBA163420...C	971	88,7	89,3	89,7	0,78	22,9	6,6	108	1,3	2,8	0,102	134	57
15	M2BAX 180MLA 6	3GBA183410...C	971	89,7	90,0	89,6	0,76	32	7,4	147	2,4	3,9	0,136	169	62
18,5	M2BAX 200MLA 6	3GBA203410...C	978	90,4	90,7	90,0	0,76	38,5	6,1	181	2,0	2,9	0,204	205	61
22	M2BAX 200MLB 6	3GBA203420...C	978	90,9	91,1	90,5	0,76	45,6	6,2	215	1,8	2,9	0,227	219	62
30	M2BAX 225SMA 6	3GBA223210...C	987	91,7	91,5	90,5	0,78	60,6	7,0	290	2,7	3,2	0,579	284	64
37	M2BAX 250SMA 6	3GBA253210...C	986	92,2	92,5	91,9	0,80	71,9	6,9	359	2,6	2,9	0,783	337	66
45	M2BAX 280SMD 6	3GBA283240...H	990	92,7	92,8	92,4	0,80	88,2	7,1	434	2,7	3,1	1,3	498	62
55	M2BAX 280SME 6	3GBA283250...H	989	93,1	93,2	92,8	0,81	105	6,9	531	2,7	2,9	1,5	523	66
75	M2BAX 315SMA 6	3GBA313210...C	992	93,7	93,7	92,6	0,81	143	7,0	721	2,1	2,7	3,2	722	75
90	M2BAX 315SMB 6	3GBA313220...C	992	94,0	94,1	93,2	0,83	165	7,2	866	2,1	2,7	4,1	817	75
110	M2BAX 315SMC 6	3GBA313230...C	992	94,3	94,4	93,7	0,83	203	7,0	1058	2,2	2,7	4,9	887	75
132	M2BAX 315MLA 6	3GBA313410...C	992	94,6	94,7	94,0	0,83	243	7,2	1270	2,4	2,7	5,8	997	75
160	M2BAX 355SMA 6	3GBA353210...C	992	94,8	94,9	94,2	0,83	293	6,2	1540	2,1	2,3	7,3	1309	77
200	M2BAX 355SMB 6	3GBA353220...C	992	95,0	95,2	94,6	0,84	360	6,5	1925	2,1	2,3	9,7	1459	77
250	M2BAX 355SMC 6	3GBA353230...C	991	95,0	95,2	94,8	0,84	450	6,7	2409	2,3	2,3	11,3	1609	77

Variant codes

General performance cast iron motors

Variant codes specify additional options and features to the standard motor. The desired features are listed as three-digit variant codes in the motor order. Note also that there are variants that cannot be used together.

Most of the variant codes apply to IE2 and IE3 motors. For details please contact your ABB sales office before making an order.

Code/Variants M2BAX	Frame size													
	71	80	90	100	112	132	160	180	200	225	250	280	315	355
Administration														
531	Sea freight packing	•	•	•	•	•	•	•	•	•	•	•	•	•
Bearings and Lubrication														
037	Roller bearing at D-end.	-	-	-	-	-	•	•	•	•	•	•	•	•
041	Bearings regreasable via grease nipples.	-	-	-	-	-	•	•	•	•	•	○	○	○
043	SPM compatible nipples for vibration measurement	-	-	-	-	-	•	•	•	•	•	•	•	•
188	63-series bearing in D-end	-	-	-	-	-	•	•	•	•	•	○	-	-
Branch standard designs														
178	Stainless steel / acid proof bolts.	•	•	•	•	•	•	•	•	•	•	•	•	•
Cooling system														
068	Light alloy metal fan	•	•	•	•	•	•	•	•	•	•	•	•	•
183	Separate motor cooling (fan axial, N-end).	•	•	•	•	•	•	•	•	•	•	•	•	-
Drain holes														
065	Plugged existing drain holes.	•	•	•	•	•	•	•	•	•	•	•	•	•
Heating elements														
450	Heating element, 100-120 V	•	•	•	•	•	•	•	•	•	•	•	•	•
451	Heating element, 200 - 240 V	•	•	•	•	•	•	•	•	•	•	•	•	•
Marine														
096	Fulfilling Lloyds Register of Shipping (LR) requirements, without certificate (non-essential duty only)	•	•	•	•	•	•	•	•	•	•	•	•	•
186	Fulfilling Det Norske Veritas (DNV) requirements, without certificate	•	•	•	•	•	•	•	•	•	•	•	•	•
492	Fulfilling Registro Italiano Navale (RINA) requirements, without certificate.	•	•	•	•	•	•	•	•	•	•	•	•	•
496	Fulfilling Bureau Veritas (BV) requirements, without certificate (non-essential duty only)	•	•	•	•	•	•	•	•	•	•	•	•	•
675	Fulfilling American Bureau of Shipping (ABS) requirements, without certificate (non-essential duty only)	•	•	•	•	•	•	•	•	•	•	•	•	•
676	Fulfilling Germanischer Lloyd (GL) requirements, without certificate (non-essential duty only)	•	•	•	•	•	•	•	•	•	•	•	•	•
Mounting arrangements														
008	IM 2101 foot/flange mounted, IEC flange, from IM 1001 (B34 from B3).	•	•	•	•	•	•	-	-	-	-	-	-	-
009	IM 2001 foot/flange mounted, IEC flange, from IM 1001 (B35 from B3).	•	•	•	•	•	•	•	•	•	•	•	•	•
047	IM 3601 flange mounted, IEC flange, from IM 3001 (B14 from B5).	•	•	•	•	•	•	-	-	-	-	-	-	-
048	IM 3001 flange mounted, IEC flange, from IM 3601 (B5 from B14).	•	•	•	•	•	•	-	-	-	-	-	-	-
066	Modified for specified mounting position differing from IM B3 (1001), IM B5 (3001), B14 (3601), IM B35 (2001), IM B34 (2101)	•	•	•	•	•	•	•	•	•	•	•	•	•
Painting														
114	Special paint color, standard grade	•	•	•	•	•	•	•	•	•	•	•	•	•
Protection														
005	Protective roof	•	•	•	•	•	•	•	•	•	•	•	•	•
072	Radial seal at D-end. Not possible for 2-pole, 280 and 315 frames	•	•	•	•	•	•	•	•	•	•	•	•	•
158	Degree of protection IP65.	•	•	•	•	•	•	•	•	•	•	•	•	•
403	Degree of protection IP56.	•	•	•	•	•	•	•	•	•	•	•	•	•
784	Gamma-seal at D-end.	•	•	•	•	•	•	•	•	•	•	•	•	•
Rating & instruction plates														
002	Restamping voltage, frequency and output, continuous duty.	•	•	•	•	•	•	•	•	•	•	•	•	•
095	Restamping output (maintained voltage, frequency), intermittent duty.	•	•	•	•	•	•	•	•	•	•	•	•	•
135	Mounting of additional identification plate, stainless.	•	•	•	•	•	•	•	•	•	•	•	•	•
159	Additional plate with text "Made in"	-	-	-	-	-	•	•	•	•	•	•	•	•

○ = Included as standard | • = Available as option | - = Not applicable

Code/Variants M2BAX	Frame size													
	71	80	90	100	112	132	160	180	200	225	250	280	315	355
161	Additional rating plate delivered loose.	•	•	•	•	•	•	•	•	•	•	•	•	•
163	Frequency converter rating plate. Rating data according to quotation.	•	•	•	•	•	•	•	•	•	•	•	•	•
181	Rating plate with ABB standard loadability values for VSD operation. Other auxiliaries for VSD operation to be selected as necessary.	•	•	•	•	•	•	•	•	•	•	•	•	•
818	Restamping as generator	-	-	-	-	-	•	•	•	•	•	•	•	•
Shaft & rotor														
131	Motor delivered with half key (key not exceeding shaft diameter)	-	-	-	-	-	•	•	•	•	•	-	-	-
Standards and Regulations														
331	IE1 motor not for sale for use in EU	•	•	•	•	•	•	•	•	•	•	•	•	•
540	China energy label	•	•	•	•	•	•	•	•	•	•	•	•	•
548	Certificate of conformity according TR-CU 004/2011 for customs union RU, KZ, BY, AM, KG.	•	•	•	•	•	•	•	•	•	•	•	•	•
822	WIMES 3.03i6 Compliant Design for DOL operation	•	•	•	•	•	•	•	•	•	•	•	•	•
823	WIMES 3.03i6 Compliant Design for VSD operation	•	•	•	•	•	•	•	•	•	•	•	•	•
Stator winding temperature sensors														
122	Bimetal detectors, break type (NCC), (3 in series), 150 °C, in stator winding	•	•	•	•	•	•	•	•	•	•	•	•	•
435	PTC - thermistors (3 in series), 130 °C, in stator winding	•	•	•	•	•	•	•	•	•	•	•	•	•
439	PTC - thermistors (2x3 in series), 150 °C, in stator winding	•	•	•	•	•	•	•	•	•	•	•	•	•
445	Pt100 2-wire in stator winding, 1 per phase	•	•	•	•	•	•	•	•	•	•	•	•	•
Terminal box														
022	Cable entry LHS (seen from D-end).	•	•	•	•	•	•	•	•	•	•	•	•	•
230	Standard metal cable gland.	•	•	•	•	•	•	•	•	•	•	•	•	•
375	Standard plastic cable gland	•	•	•	•	•	•	•	•	•	•	-	-	-
376	Two standard plastic cable glands	•	•	•	•	•	•	•	•	•	•	-	-	-
400	4 x 90 degr turnable terminal box.	•	•	•	•	•	○	○	○	○	○	○	○	○
418	Separate terminal box for auxiliaries, standard material.	•	•	•	•	•	•	•	•	•	•	-	-	-
447	Top mounted separate terminal box for monitoring equipment.	-	-	-	-	-	-	-	-	-	-	•	•	•
468	Cable entry from D-end.	-	-	-	-	-	-	-	-	-	-	•	•	•
731	Two standard metal cable glands.	•	•	•	•	•	•	•	•	•	•	•	•	•
Testing														
145	Type test report from a catalogue motor, 400V 50Hz.	•	•	•	•	•	•	•	•	•	•	•	•	•
148	Routine test report.	•	•	•	•	•	•	•	•	•	•	•	•	•
Variable speed drives														
470	Prepared for hollow shaft pulse tacho (L&L equivalent).	-	-	-	-	-	•	•	•	•	•	-	-	-
472	1024 pulse tacho (L&L 861007455-1024).	-	-	-	-	-	•	•	•	•	•	-	-	-
473	2048 pulse tacho (L&L 861007455-2048).	-	-	-	-	-	•	•	•	•	•	-	-	-
701	Insulated bearing at N-end.	-	-	-	-	-	-	-	-	-	-	•	•	•
704	EMC cable entry.	•	•	•	•	•	•	•	•	•	•	•	•	•

○ = Included as standard | • = Available as option | - = Not applicable

Mechanical design

Bearings

General performance motors are normally fitted with single-row deep-groove ball bearings, as shown in the table below.

If the bearing at the D-end is replaced with a roller bearing (NU- or NJ-), higher radial forces can be handled. Roller bearings are suitable for belt-drive applications and can be ordered with variant code 037.

Standard and alternative designs

Motor size	Poles	Standard design		Alternative design
		Deep groove ball bearings		Deep groove ball bearings
		D-end	N-end	Roller bearings (VC037) D-end
71	2 - 6	6203-2Z/C3	6202-2Z/C3	
80	2 - 6	6204-2Z/C3	6203-2Z/C3	
90	2 - 6	6205-2Z/C3	6204-2Z/C3	
100	2 - 6	6206-2Z/C3	6205-2Z/C3	
112	2 - 6	6206-2Z/C3	6205-2Z/C3	
132	2 - 4	6208-2Z/C3	6208-2Z/C3	NU 208 ECP/C3
160	2 - 6	6209-2Z/C3	6209-2Z/C3	NU 209 ECP/C3
180	2 - 6	6210-2Z/C3	6209-2Z/C3	NU 210 ECP/C3
200	2 - 6	6212-2Z/C3	6209-2Z/C3	NU 212 ECP/C3
225	2 - 6	6213-2Z/C3	6210-2Z/C3	NU 213 ECP/C3
250	2 - 6	6215-2Z/C3	6212-2Z/C3	NU 215 ECP/C3
280	2 - 6	6316/C3	6316/C3	NU 316 ECP/C3
315 IE2, IE3	2	6217/C3	6217/C3	NU 217 ECP/C3
315 IE2, IE3	4 - 6	6219/C3	6217/C3	NU 219 ECP/C3
355 IE2, IE3	2	6219/C3	6219/C3	NU 219 ECP/C3
355 IE2, IE3	4 - 6	6222/C3	6219/C3	NU 222 ECP/C3

Axially-locked bearings

All motors are equipped as standard with an axially locked bearing at the D-end.

Mechanical design

Radial forces

Permissible loading on the shaft

The following table shows permissible radial forces on the shaft in Newtons, assuming zero axial force, a 25 °C ambient temperature, and normal conditions. The values are given for a calculated bearing life of 20 000 and 40 000 hours per motor size.

These calculated values further assume mounting position IM B3 (foot-mounted), with force directed sideways. In some cases, the strength of the shaft affects permissible forces.

Permissible loads of simultaneous radial and axial forces can be supplied on request.

If the radial force is applied between points X0 and Xmax, the permissible force F_R can be calculated with the following formula:

$$F_R = F_{X0} - \frac{X}{E} (F_{X0} - F_{Xmax})$$

Where:

E: length of the shaft extension in the standard version

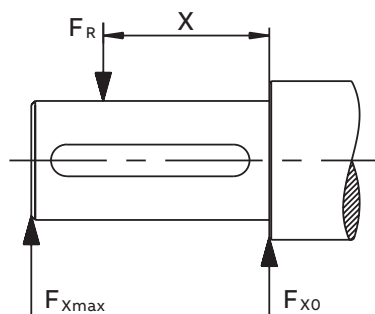

Permissible radial forces

Motor size	Poles	Lenght of shaft extension E (mm)	Ball bearings				Roller bearings			
			20,000 h		40,000 h		20,000 h		40,000 h	
			F_{x0} (N)	F_{xmax} (N)	F_{x0} (N)	F_{xmax} (N)	F_{x0} (N)	F_{xmax} (N)	F_{x0} (N)	F_{xmax} (N)
71	2	30	545	465	430	370				
	4	30	685	585	545	465				
	6	30	785	660	620	530				
80	2	40	740	620	585	490				
	4	40	925	775	730	615				
	6	40	1065	890	840	705				
90S	2	50	795	645	625	510				
	4	50	1000	815	790	645				
	6	50	1145	935	905	740				
90L	2	50	795	660	630	520				
	4	50	1005	830	790	655				
	6	50	1150	950	910	750				
100	2	60	1110	895	875	705				
	4	60	1395	1120	1100	885				
	6	60	1605	1290	1265	1020				
112	2	60	1120	925	885	730				
	4	60	1405	1160	1105	915				
	6	60	1615	1335	1275	1050				
132S	2	80	1630	1270	1285	1000				
	4	80	2055	1600	1620	1260				
	6	80	2360	1840	1860	1450				
132M	4	80	2075	1665	1630	1310				
	6	80	2375	1905	1865	1495				
160	2	110	1945	1510	1545	1195				
	4	110	2455	1905	1945	1510				
	6	110	2835	2250	2245	1780				
180	2	110	2095	1705	1660	1350				
	4	110	2640	2145	2090	1700				
	6	110	3025	2460	2395	1950				
200	2	110	2800	2350	2200	1830				
	4	110	3550	2910	2810	2305				
	6	110	4065	3335	3220	2640				
225	2	110	3335	2795	2640	2215				
	4	140	4200	3370	3325	2670				
	6	140	4810	3860	2805	3055				
250	2	140	3965	3220	3140	2550				
	4	140	4995	4060	3995	3215				
	6	140	5715	4645	4525	3675				
280	2	140	6590	5500	5100	4250	22700	7200	18350	7200
	4	140	8310	6930	6430	5360	27900	9500	22550	9500
	6	140	9460	7890	7310	6090	31550	9500	25450	9500
315 IE2, IE3	2	140	4900	4150	3850	3250	14900	6650	12100	6650
	4	170	8000	6650	6350	5250	21200	10350	17200	10350
	6	170	9150	7550	7200	5950	23900	10250	19400	10250
355 IE2, IE3	2	140	6250	5500	4900	4300	17200	7850	13950	7850
	4	210	10500	8700	8250	6800	28050	16250	22750	16250
	6	210	12000	9900	9400	7750	31650	16200	25700	16200

Mechanical design

Axial forces

01 Mounting arrangement IM B3.

The following tables present permissible axial forces on the shaft in Newtons, assuming zero radial force, a 25 °C ambient temperature, and normal conditions. The values are given for a calculated bearing life of 20,000 and 40,000 hours per motor size.

At 60 Hz, the values must be reduced by 10 percent, and for two-speed motors, the higher speed determines permissible axial force. Permissible loads of simultaneous radial and axial forces can be supplied on request.

For axial force F_{AD} , it is assumed that the D-bearing is locked with a locking ring.

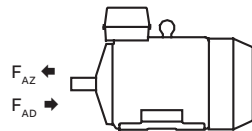

01

Permissible axial forces

Motor size	Poles	Length of shaft extension E (mm)	Mounting arrangement IM B3			
			Deep groove ball bearings			
			20,000 h		40,000 h	
			F_{AD} (N)	F_{AZ} (N)	F_{AD} (N)	F_{AZ} (N)
71	2	30	580	300	465	185
	4	30	725	445	580	300
	6	30	810	530	670	390
80	2	40	750	430	595	275
	4	40	940	620	750	430
	6	40	1055	735	870	550
90	2	50	845	445	675	275
	4	50	1050	650	840	440
	6	50	1175	775	935	535
100	2	60	1175	615	940	380
	4	60	1465	905	1175	615
	6	60	1640	1080	1305	745
112	2	60	1175	615	935	375
	4	60	1460	900	1170	610
	6	60	1635	1075	1300	740

Permissible axial forces

Motor size	Poles	Length of shaft extension E (mm)	Mounting arrangement IM B3			
			Deep groove ball bearings			
			20,000 h		40,000 h	
			$F_{AD}(N)$	$F_{AZ}(N)$	$F_{AD}(N)$	$F_{AZ}(N)$
132	2	80	1675	795	1415	535
	4	80	2110	1230	1665	785
	6	80	2450	1570	1950	1070
160	2	110	1665	1205	1300	840
	4	110	2135	1675	1650	1190
	6	110	2465	2005	1895	1435
180	2	110	1730	1275	1345	890
	4	110	2215	1755	1705	1245
	6	110	2590	2130	1990	1530
200	2	110	2240	1780	1725	1265
	4	110	2900	2445	2215	1755
	6	110	3400	2945	2595	2135
225	2	110	2440	2210	1845	1615
	4	140	3195	2965	2395	2170
	6	140	3745	3520	2810	2580
250	2	140	2860	2620	2155	1920
	4	140	3765	3525	2825	2585
	6	140	4420	4180	3310	3070
280	2	140	6060	4060	4530	2530
	4	140	7380	5380	6010	4010
	6	140	8850	6850	6710	4710
315 IE2, IE3	2	140	4150	2150	3300	1300
	4	170	6600	4600	5100	3100
	6	170	7550	5550	5800	3800
355 IE2, IE3	2	140	4900	3200	3800	2100
	4	210	8050	6300	6100	4350
	6	210	9250	7500	6950	5200

Terminal box

Standard terminal box

01 Terminal box for sizes 71 to 132.

02 Terminal box for sizes 160 to 180.

03 Terminal box for sizes 200 to 250.

04 Terminal box for sizes 280 to 355.

05 Terminal board for sizes 71 to 132.

06 Terminal board for sizes 160 to 180.

07 Terminal board for sizes 200 to 250.

08 Terminal board for sizes 280 to 355.

Terminal boxes

The pictures below show standard terminal boxes.

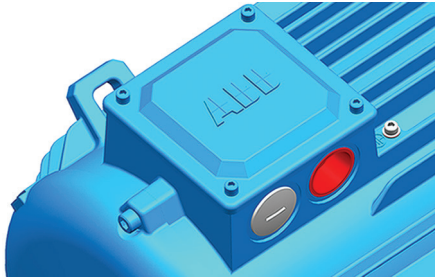

01

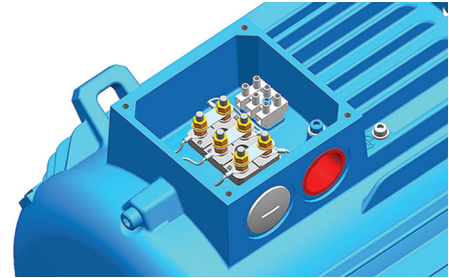

05

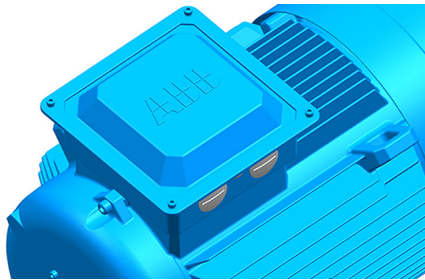

02

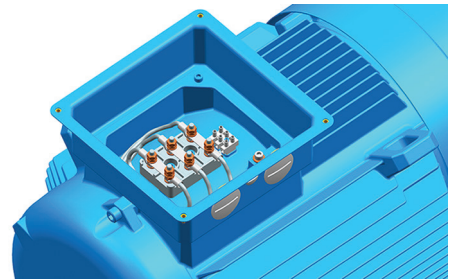

06

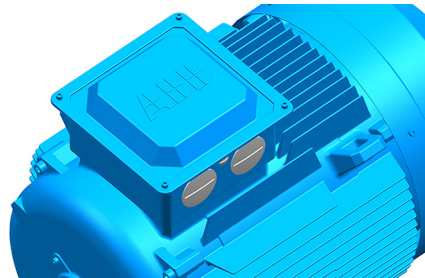

03

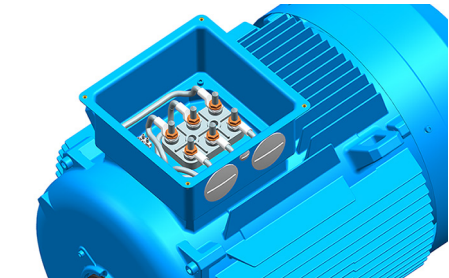

07



04

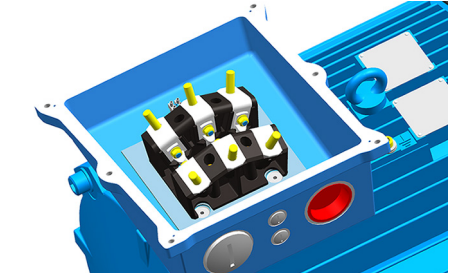

08

Dimension drawings

General performance IE3 cast iron motors

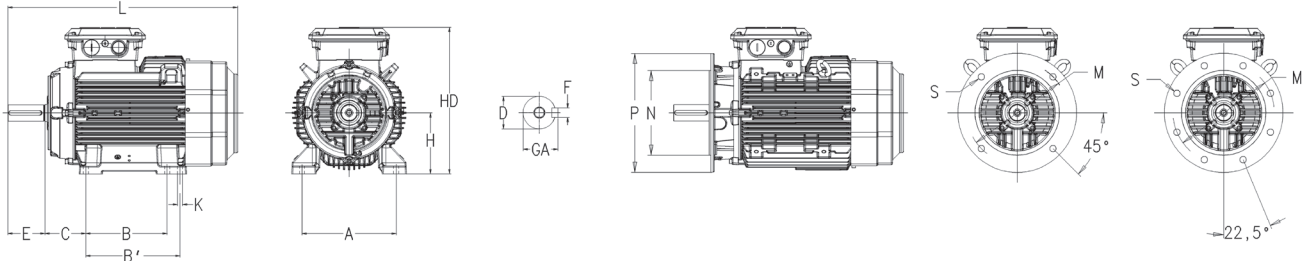

Foot-mounted motor IM1001, B3 and flange-mounted motor IM3001, B5

Motor size	D poles		GA poles		F poles		E poles		L max poles		A	B	B'	C	HD max	K	M	N	P	S
	2	4-8	2	4-8	2	4-8	2	4-8	2	4-8										
71M	14	14	16	16	5	5	30	30	257	257	112	90	-	45	175	7	130	110	160	10
71ML	14	14	16	16	5	5	30	30	282	282	112	90	-	45	175	7	130	110	160	10
80M	19	19	21,5	21,5	6	6	40	40	309	309	125	100	-	50	192	10	165	130	200	12
80ML	19	19	21,5	21,5	6	6	40	40	334	334	125	100	112	50	192	10	165	130	200	12
90S	24	24	27	27	8	8	50	50	335	335	140	100	-	56	217	10	165	130	200	12
90SL	24	24	27	27	8	8	50	50	351	351	140	100	125	56	217	10	165	130	200	12
90L_	24	24	27	27	8	8	50	50	386	386	140	125	-	56	217	10	165	130	200	12
100L_	28	28	31	31	8	8	60	60	376	376	160	140	-	63	240	12	215	180	250	14,5
100LK_	28	28	31	31	8	8	60	60	411	411	160	140	160	63	240	12	215	180	250	14,5
112M_	28	28	31	31	8	8	60	60	411	411	190	140	-	70	252	12	215	180	250	14,5
112ML_	28	28	31	31	8	8	60	60	456	456	190	140	159	70	252	12	215	180	250	14,5
132S_	38	38	41	41	10	10	80	80	521	521	216	140	178	89	302	12	265	230	300	14,5
132M_	38	38	41	41	10	10	80	80	586	586	216	178	203	89	302	12	265	230	300	14,5
160 ¹⁾	42	42	45	45	12	12	110	110	586,5	586,5	254	210	254	108	413	14,5	300	250	350	18,5
160 ²⁾	42	42	45	45	12	12	110	110	626,5	626,5	254	210	254	108	413	14,5	300	250	350	18,5
160 ³⁾	42	42	45	45	12	12	110	110	683,5	683,5	254	210	254	108	413	14,5	300	250	350	18,5
180 ⁴⁾	48	48	51,5	51,5	14	14	110	110	683,5	683,5	279	241	279	121	434	14,5	300	250	350	18,5
180 ⁵⁾	48	48	51,5	51,5	14	14	110	110	743,5	743,5	279	241	279	121	434	14,5	300	250	350	18,5
200 MLA6	55	55	59	59	16	16	110	110	728	728	318	267	305	133	473	18,5	350	300	400	18,5
200 ⁶⁾	55	55	59	59	16	16	110	110	828	828	318	267	305	133	473	18,5	350	300	400	18,5
225 SM_	55	60	59	64	16	18	110	140	824	854	356	286	311	149	539	18,5	400	350	450	18,5
250 SMA	60	65	64	69	18	18	140	140	882	927	406	311	349	168	585	24	500	450	550	18,5
280	65	75	69	79,5	18	20	140	140	1012	1012	457	368	419	190	775	24	500	450	550	18,5
315 SM_	65	80	69	85	18	22	140	170	1216	1246	508	406	457	216	849	28	600	550	660	24
315 ML_	65	90	69	95	18	25	140	170	1326	1356	508	457	508	216	849	28	600	550	660	24
355 SM_	70	100	74,5	106	20	28	140	210	1399	1469	610	500	560	254	933	35	740	680	800	24

¹⁾ MLA 2, MLB 2

²⁾ MLA 4, MLA 6

³⁾ MLC 2, MLB 4, MLB 6

⁴⁾ MLA 2, MLA 4

⁵⁾ MLB 4, MLA 6

⁶⁾ All types except MLA6

IMB14 (IM3601)

Motor size	M	N	P	S	T
71	85	70	105	6	2.5
80	100	80	120	6	3
90	115	95	140	8	3
100	130	110	160	8	3.5
112	130	110	160	8	3.5
132	165	130	200	10	3.5

Dimension drawings

General performance IE2 cast iron motors

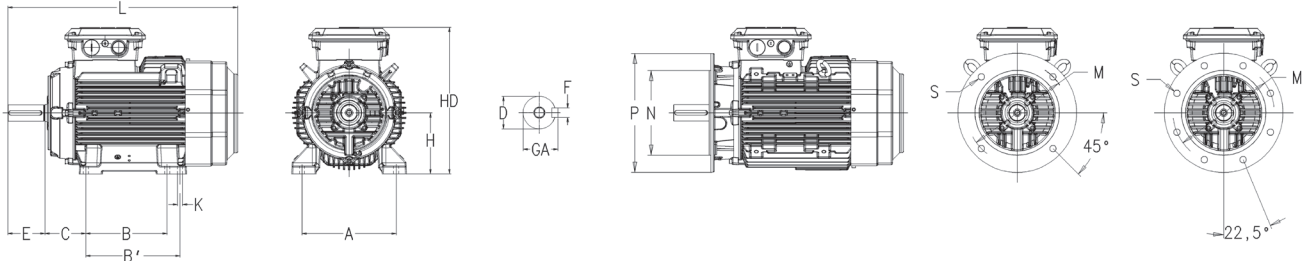

Foot-mounted motor IM1001, B3 and flange-mounted motor IM3001, B5

Motor size	D poles		GA poles		F poles		E poles		L max poles		A	B	B'	C	HD max	K	M	N	P	S
	2	4-8	2	4-8	2	4-8	2	4-8	2	4-8										
71M	14	14	16	16	5	5	30	30	257	257	112	90	-	45	175	7	130	110	160	10
71ML	14	14	16	16	5	5	30	30	282	282	112	90	-	45	175	7	130	110	160	10
80M	19	19	21,5	21,5	6	6	40	40	309	309	125	100	-	50	192	10	165	130	200	12
80ML	19	19	21,5	21,5	6	6	40	40	334	334	125	100	112	50	192	10	165	130	200	12
90S	24	24	27	27	8	8	50	50	335	335	140	100	-	56	217	10	165	130	200	12
90SL	24	24	27	27	8	8	50	50	351	351	140	100	125	56	217	10	165	130	200	12
90L	24	24	27	27	8	8	50	50	351	351	140	125	-	56	217	10	165	130	200	12
100L	28	28	31	31	8	8	60	60	376	376	160	140	-	63	240	12	215	180	250	14,5
100LK	28	28	31	31	8	8	60	60	411	411	160	140	160	63	240	12	215	180	250	14,5
112M	28	28	31	31	8	8	60	60	411	411	190	140	-	70	252	12	215	180	250	14,5
112ML	28	28	31	31	8	8	60	60	456	456	190	140	159	70	252	12	215	180	250	14,5
132S	38	38	41	41	10	10	80	80	479	479	216	140	-	89	302	12	265	230	300	14,5
132SM	38	38	41	41	10	10	80	80	521	521	216	140	178	89	302	12	265	230	300	14,5
132M	38	38	41	41	10	10	80	80	521	521	216	178	-	89	302	12	265	230	300	14,5
132ML	38	38	41	41	10	10	80	80	586	586	216	178	203	89	302	12	265	230	300	14,5
160 ¹⁾	42	42	45	45	12	12	110	110	586,5	586,5	254	210	254	108	414	14,5	300	250	350	18,5
160 ²⁾	42	42	45	45	12	12	110	110	626,5	626,5	254	210	254	108	414	14,5	300	250	350	18,5
180	48	48	51,5	51,5	14	14	110	110	683,5	683,5	279	241	279	121	454	14,5	300	250	350	18,5
200	55	55	59	59	16	16	110	110	728	728	318	267	305	133	515	18,5	350	300	400	18,5
225	55	60	59	64	16	18	110	140	824	854	356	286	311	149	560	18,5	400	350	450	18,5
250	60	65	64	69	18	18	140	140	882	882	406	311	349	168	613	24	500	450	550	18,5
280	65	75	69	79,5	18	20	140	140	1012	1012	457	368	419	190	710	24	500	450	550	18,5
315 SM_	65	80	69	85	18	22	140	170	1216	1246	508	406	457	216	849	28	600	550	660	24
315 ML_	65	90	69	95	18	25	140	170	1326	1356	508	457	508	216	849	28	600	550	660	24
355 SM_	70	100	74,5	106	20	28	140	210	1399	1469	610	500	560	254	933	35	740	680	800	24

¹⁾ All types except MLB6

²⁾ MLB 6

IMB14 (IM3601)

Motor size	M	N	P	S	T
71	85	70	105	6	2,5
80	100	80	120	6	3
90	115	95	140	8	3
100	130	110	160	8	3,5
112	130	110	160	8	3,5
132	165	130	200	10	3,5

Motors in brief

Cast iron motors, sizes 71 - 112

Motor size	M2BAX	71	80	90	100	112
Stator and end shields	Material	Cast iron				
	Paint color shade	Munsell blue 8B 4.5/3.25				
	Corrosion class	C3				
Feet	Material	Integrated cast iron				
Bearings	D-end	6203-2Z/C3	6204-2Z/C3	6205-2Z/C3	6206-2Z/C3	6206-2Z/C3
	N-end	6202-2Z/C3	6203-2Z/C3	6204-2Z/C3	6205-2Z/C3	6205-2Z/C3
Axially locked bearings		Locked at D-end with retaining ring				
Bearing seals	D-end	V-ring				
	N-end	V-ring				
Lubrication		Permanently lubricated shielded bearings				
Measuring nipples for condition monitoring of the bearings		Not Included				
Rating plate	Material	Stainless steel				
Terminal box	Cover, material	Steel				
	Corrosion class	C3				
	Cover screws	Zinc-electroplated steel				
Connections	Threaded openings	2xM16, 1xM16	2xM25, 1xM16		2xM32, 1xM16	
	Max Cu-area mm	4	6		10	
	Terminals	6 terminals for connection with cable lugs (not included)				
	Cable glands	Glands as option				
Fan	Material	Glass-fiber reinforced polypropylene				
Fan cover	Material	Steel				
	Paint color shade	Munsell blue 8B 4.5/3.25				
	Corrosion class	C3				
Stator winding	Material	Copper				
	Insulation	Insulation class F. Temperature rise class B unless otherwise stated.				
	Winding protection	3 PTC thermistors, 150°C				
Rotor winding	Material	Pressure die-cast aluminum				
Balancing method		Half key balancing as standard				
Key ways		Open key way				
Drain holes		Drain holes with closable plastic plugs, open on delivery				
Enclosure		IP 55 Higher protection on request				
Cooling method		IC 411				
Lifting lugs		Integrated cast iron lifting lugs				

Motors in brief

Cast iron motors, sizes 132 - 250

Motor size	M2BAX	132	160	180	200	225	250
Stator and end shields	Material	Cast iron					
	Paint color shade	Munsell blue 8B 4.5/3.25					
	Corrosion class	C3					
Feet	Material	Integrated cast iron feet					
Bearings	D-end	6208-2Z/C3	6209-2Z/C3	6210-2Z/C3	6212-2Z/C3	6213-2Z/C3	6215-2Z/C3
	N-end	6208-2Z/C3	6209-2Z/C3	6209-2Z/C3	6209-2Z/C3	6210-2Z/C3	6212-2Z/C3
Axially locked bearings		Locked at D-end with retaining ring	Locked at D-end with inner bearing cover				
Bearing seals	D-end	V-ring					
	N-end	V-ring					
Lubrication		Permanently lubricated shielded bearings					
Measuring nipples for condition monitoring of the bearings		Not Included					
Rating plate	Material	Stainless steel					
Terminal box	Cover, material	Steel					
	Corrosion class	C3					
	Cover screws	Zinc-electroplated steel					
Connections	Threaded openings	2xM32	2xM40, 1xM16		2xM63, 1xM16		
	Terminals	6 terminals for connection with cable lugs (not included)					
	Cable glands	Glands as option		Cable flange included, glands as option			
Fan	Material	Glass-fiber reinforced polypropylene					
Fan cover	Material	Steel					
	Paint color shade	Munsell blue 8B 4.5/3.25					
	Corrosion class	C3					
Stator winding	Material	Copper					
	Insulation	Insulation class F. Temperature rise class B unless otherwise stated.					
	Winding protection	3 PTC thermistors, 150 °C					
Rotor winding	Material	Pressure die-cast aluminum					
Balancing method		Half-key balancing as standard					
Key ways		Open key way					
Drain holes		Drain holes with closable plastic plugs, open on delivery					
Enclosure		IP 55 Higher protection on request					
Cooling method		IC 411					
Lifting lugs		Integrated cast iron lifting lug					

Motors in brief

Cast iron motors, sizes 280 - 355

Motor size	M2BAX	280	315	355
Stator and end shields	Material	Cast iron		
	Paint color shade	Munsell blue 8B 4.5/3.25		
	Corrosion class	C3		
Feet		Integrated cast iron		
Bearings	D-end 2-pole	6316/C3	6217/C3 or 6316/C3	6219/C3 or 6319/C3
	D-end 4-6 -pole	6316/C3	6219/C3 or 6316/C3	6222/C3 or 6322/C3
	N-end 2-pole	6316/C3	6217/C3 or 6316/C3	6219/C3 or 6316/C3
	N-end 4-6 -pole	6316/C3	6217/C3 or 6316/C3	6219/C3 or 6316/C3
Axially locked bearings		Locked at D-end with inner bearing cover		
Bearing seals	D-end	V-ring		
	N-end	V-ring		
Lubrication		Regreasable bearings, regreasing nipples M6x1		
Measuring nipples for condition monitoring of the bearings		Not included		
Rating plate	Material	Stainless steel		
Terminal box	Material frame	Cast iron		
	Cover	Cast iron terminal box cover		
	Corrosion class	C3		
	Screws	Zinc-electroplated steel		
Connections	Threaded openings	2xM63, 2 x M20	2xM63, 2 x M20	2xM75, 2 x M20
	Terminals	6 terminals for connection with cable lugs (not included)		
	Cable glands	Cable glands as option		
Fan	Material	Glass-fiber reinforced polypypropylene		
Fan cover	Material	Steel fan cover		
	Paint color shade	Black / Munsell blue 8B 4.5/3.25		
	Corrosion class	C3		
Stator winding	Material	Copper		
	Insulation	Insulation class F. Temperature rise class B unless otherwise stated.		
	Winding protection	3 PTC thermistors, 150 °C		
Rotor winding	Material	Pressure diecast aluminum		
Balancing method		Half key balancing as standard		
Keyway		Open key way		
Heating elements	On request	60 W	2x60 W	2x60 W
Enclosure		IP 55 Higher protection on request		
Cooling method		IC 411		
Drain holes		Drain holes with closable plastic plugs, open on delivery		
Lifting lugs		Bolted lifting lugs		

Total product offering

Motors, generators and mechanical power transmission products with a complete portfolio of services



IEC motors

- Low voltage motors
- High voltage induction and synchronous motors
- Marine motors
- Motors for explosive atmospheres
- Motors for food and beverage
- Motors for variable speed drives
- Permanent magnet motors
- Synchronous reluctance motors
- Traction motors

NEMA motors

- Low voltage motors
- High voltage induction and synchronous motors
- Marine motors
- Motors for explosive atmospheres
- Motors for variable speed drives
- Permanent magnet motors
- Servomotors
- Washdown motors

Generators

- Generators for wind turbines
- Generators for diesel and gas engine power plants
- Generators for steam and gas turbine power plants
- Generators for marine applications
- Generators for industrial applications
- Generators for traction applications
- Synchronous condensers for reactive power compensation

Mechanical power transmission components, bearings, gears

- Mounted bearings
- Enclosed gearing
- Mechanical drive components
- Couplings
- Sheaves and bushings
- Conveyor components
- Geared motor units

Life cycle services

ABB's portfolio of drives

Optimal solution for you



Being able to rely on the continuous high performance and efficiency of your operations is something you want to take for granted. ABB variable-frequency drives are made with all this in mind, established upon more than 40 years of experience and backed by a broad range of life cycle services.

ABB drives help you to optimize your processes and systems with state-of-the-art motor control technology, resulting in increased energy efficiency, better product quality, and reduced operating costs with higher output, less downtime, and reduced need for maintenance. All ABB drives are designed for easy selection, ordering, installation and use, and they offer integrated safety features, giving you more time to focus on what matters for you and your business.

Our portfolio offers low-voltage AC and DC drives, medium-voltage AC drives, and motion control drives spanning the fractional-kilowatt to multi-megawatt power level. There is a drive available for essentially every industry and application, which can be used with all types of motors, in environments ranging from clean electrical rooms in buildings, to harsh coal mines and windy offshore platforms. This wide product range allows you to select the best-fitting drive solution, providing maximum reliability and efficiency for every need.

Contact us



For more information and contact details:

www.abb.com/motors&generators