

SIEMENS



SINAMICS Drives

**SINAMICS G120P and
SINAMICS G120P Cabinet
pump, fan, compressor
converters**

Catalog
D 35

Edition
June 2018

siemens.com/drives

Related catalogs

<p>Motion Control Drives SINAMICS S120 and SIMOTICS</p> <p>D 21.4</p> <p>E86060-K5521-A141-A1-7600</p>		<p>SIMATIC HMI / PC-based Automation Human Machine Interface Systems PC-based Automation</p> <p>ST 80/ST PC</p> <p>E86060-K4680-A101-C5-7600</p>	
<p>SINAMICS G130 Drive Converter Chassis Units SINAMICS G150 Drive Converter Cabinet Units</p> <p>D 11</p> <p>E86060-K5511-A101-A6-7600</p>		<p>Industrial Communication SIMATIC NET</p> <p>IK PI</p> <p>E86060-K6710-A101-B8-7600</p>	
<p>Motion Control Drives SINAMICS Inverters for Single-Axis Drives Built-In Units</p> <p>D 31.1</p> <p>E86060-K5531-A111-A1-7600</p>		<p>SITRAIN Training for Industry</p> <p>www.siemens.com/sitrain</p>	
<p>Motion Control Drives SINAMICS Inverters for Single-Axis Drives Distributed Inverters</p> <p>D 31.2</p> <p>E86060-K5531-A121-A1-7600</p>		<p>Products for Automation and Drives Interactive Catalog Download</p> <p>CA 01</p> <p>www.siemens.com/ca01/download</p>	
<p>SIMOTICS S-1FG1 Servo geared motors Helical, Parallel shaft, Bevel and Helical worm geared motors</p> <p>D 41</p> <p>E86060-K5541-A101-A3-7600</p>		<p>Industry Mall Information and Ordering Platform on the Internet:</p> <p>www.siemens.com/industrymall</p>	
<p>SIMOTICS GP, SD, XP, DP Low-Voltage Motors Type series 1FP1, 1LE1, 1MB1 and 1PC1 Frame sizes 71 to 315 Power range 0.09 to 200 kW E86060-K5581-A111-A9-7600</p> <p>D 81.1</p>		<p>Additional information</p> <p>You will find all the latest marketing materials, such as brochures and catalogs at www.siemens.com/sinamics-g120p www.siemens.com/sinamics www.siemens.com/simotics www.siemens.com/ids</p> <p>under "Information material (brochures, catalogs)".</p> <p>You can order the available documents or download them in popular file formats (PDF, ZIP) from this site.</p> <p>NEW New products contained in this catalog.</p>	
<p>SIMOTICS FD Low-Voltage Motors Frame sizes 315 to 450 Power range 200 to 1800 kW</p> <p>D 81.8</p> <p>PDF (E86060-K5581-A181-A5-7600)</p>			
<p>FLENDER Couplings Standard Couplings</p> <p>MD 10.1</p> <p>E86060-K5710-A111-A5-7600</p>			
<p>SIMATIC Products for Totally Integrated Automation</p> <p>ST 70</p> <p>E86060-K4670-A101-B5-7600</p>			

SINAMICS G120P and SINAMICS G120P Cabinet pump, fan, compressor converters

SINAMICS Drives



Catalog D 35 · June 2018

Supersedes:
Catalog D 35 · 2017

Refer to the Industry Mall for current updates of this catalog:

www.siemens.com/industrymall

The products contained in this catalog can also be found in the Interactive Catalog CA 01.

Article No.: E86060-D4001-A510-D8-7600

Please contact your local Siemens branch.

© Siemens AG 2018



The products and systems described in this catalog are manufactured/distributed under application of a certified quality management system in accordance with ISO 9001:2008 (Certified Registration No. DE-001258 QM08) and ISO 14001:2004/Cor 1:2009 (Certified Registration No. DE-001258 UM). The certificate is recognized by all IQNet countries.

System overview

The SINAMICS drive family
Drive selection
SIMOTICS motors
Energy efficiency classes in accordance with EN 50598

1

Communication

PROFINET
PROFIdrive
PROFIBUS
Industrial Ethernet
EtherNet/IP, BACnet MS/TP, Modbus RTU, USS, FLN P1

2

System configuration

SINAMICS G120P and SINAMICS G120P Cabinet pump, fan, compressor converters
Integrated Drive Systems

3

SINAMICS G120P, built-in and wall-mounted units

CU230P-2 Control Units
PM230 Power Modules, 0.37 kW to 90 kW
PM240P-2 Power Modules, 11 kW to 132 kW
PM330 Power Modules, 160 kW to 630 kW
Supplementary system components

4

SINAMICS G120P Cabinet, converter cabinet units

75 kW to 630 kW
Versions A and C

5

Tools and configuration

SinaSave, Drive Technology Configurator, SIZER for Siemens Drives, SIZER WEB ENGINEERING, STARTER, SINAMICS Startdrive, Drive ES, EPLAN

6

Services and documentation

Partner at Industry,
Online Services, Industry Services,
Applications, Training, Training case,
Control cabinets, Spares on Web,
mySupport documentation, Documentation

7

Appendix

Certificates of suitability (approvals)
Software licenses
Metal surcharges
Conditions of sale and delivery

8

Digital Enterprise

The building blocks that ensure everything works together perfectly in the digital enterprise

Digitalization is already changing all areas of life and existing business models. It is placing greater pressure on industry while at the same time creating new business opportunities. Today, thanks to scalable solutions from Siemens, companies can already become a digital enterprise and ensure their competitiveness.



Industry faces tremendous challenges



Reduce time-to-market

Today manufacturers have to bring products to market at an ever-increasing pace despite the growing complexity of these products. In the past, a major manufacturer would push aside a small one, but now it is a fast manufacturer that overtakes a slow one.



Boost flexibility

Consumers want customized products, but at a price they would pay for a mass-produced item. That only works if production is more flexible than ever before.



Improve quality

To ensure a high level of quality while meeting legal requirements, companies have to establish closed quality loops and enable the traceability of products.



Boost efficiency

Today the product itself needs to be sustainable and environmentally friendly, while energy efficiency in production has become a competitive advantage.



Increase security

Increasing networking escalates the threat to production facilities of cyberattacks. Today more than ever, companies need suitable security measures.



The digital enterprise has already become a reality

To fully benefit from all the advantages of digitalization, companies first have to achieve complete consistency of their data. Fully digitally integrated business processes, including those of suppliers, can help to create a digital representation of the entire value chain. This requires

- the integration of industrial software and automation,
- expansion of the communication networks,
- security in automation,
- and the use of business-specific industrial services.

MindSphere

The cloud-based open IoT operating system from Siemens

With MindSphere, Siemens offers a cost-effective and scalable cloud platform as a service (PaaS) for the development of applications. The platform, designed as an open operating system for the Internet of Things, makes it possible to improve the efficiency of plants by collecting and analyzing large volumes of production data.

Totally Integrated Automation (TIA) Where digitalization becomes reality

Totally Integrated Automation (TIA) ensures the seamless transition from the virtual to the real world. It already encompasses all the necessary conditions for transforming the benefits of digitalization into true added value. The data that will form the digital twin for actual production is generated from a common base.

Digital Plant

Learn more about the digital enterprise for the process industry
www.siemens.com/digitalplant

Digital Enterprise Suite

Learn more about the digital enterprise for the discrete industry
www.siemens.com/digital-enterprise-suite

Integrated Drive Systems

Faster on the market and in the black with Integrated Drive Systems

Integrated Drive Systems are Siemens' trendsetting answer to the high degree of complexity that characterizes drive and automation technology today. The world's only true one-stop solution for entire drive systems is characterized in particular by its threefold integration: Horizontal, vertical, and lifecycle integration ensure that every drive system component fits seamlessly into the whole system, into any automation environment, and even into the entire lifecycle of a plant.

The outcome is an optimal workflow – from engineering all the way to service that entails more productivity, increased efficiency, and better availability. That's how Integrated Drive Systems reduce time to market and time to profit.

Horizontal integration

Integrated drive portfolio: The core elements of a fully integrated drive portfolio are frequency converters, motors, couplings, and gear units. At Siemens, they're all available from a single source. Perfectly integrated, perfectly interacting. For all power and performance classes. As standard solutions or fully customized. No other player in the market can offer a comparable portfolio. Moreover, all Siemens drive components are perfectly matched, so they are optimally interacting.

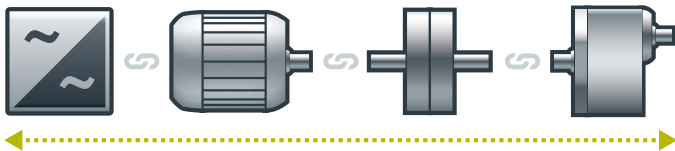

You can boost the availability of your application or plant to up to

99%*

*e.g., conveyor application

Vertical integration

Thanks to **vertical integration**, the complete drive train is seamlessly integrated in the entire automation environment – an important prerequisite for production with maximum value added. Integrated Drive Systems are part of Totally Integrated Automation (TIA), which means that they are perfectly embedded into the system architecture of the entire industrial production process. This enables optimal processes through maximum communication and control.

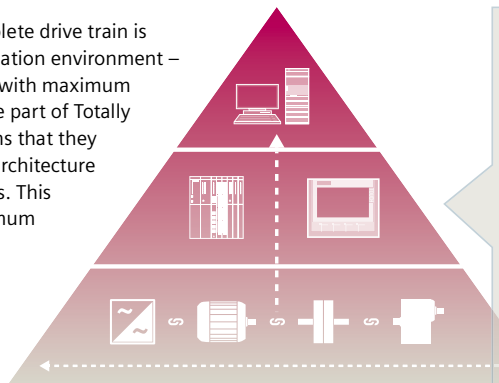

With TIA Portal you can cut your engineering time by up to

30%

Lifecycle integration

Lifecycle integration adds the factor of time: Software and service are available for the entire lifecycle of an Integrated Drive System. That way, important optimization potential for maximum productivity, increased efficiency, and highest availability can be leveraged throughout the system's lifecycle – from planning, design, and engineering to operation, maintenance, and all the way even to modernization.

With Integrated Drive Systems, assets become important success factors. They ensure shorter time to market, maximum productivity and efficiency in operation, and shorter time to profit.

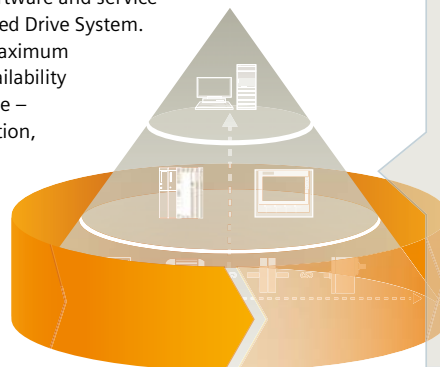

With Integrated Drive Systems you can reduce your maintenance costs by up to

15%

System overview



1/2	The SINAMICS drive family
1/2	Integration in automation
1/2	Applications
1/3	Innovative, energy-efficient and reliable drive systems and applications as well as services for the entire drive train
1/4	Energy efficiency
1/5	Variants
1/5	Platform concept
1/5	Quality management according to EN ISO 9001
1/5	IDS – Integration at its very best
1/7	Drive selection
1/7	Application
1/7	More information
1/8	SIMOTICS motors
1/9	Energy efficiency classes in accordance with EN 50598

System overview

The SINAMICS drive family

Overview

Integration in automation

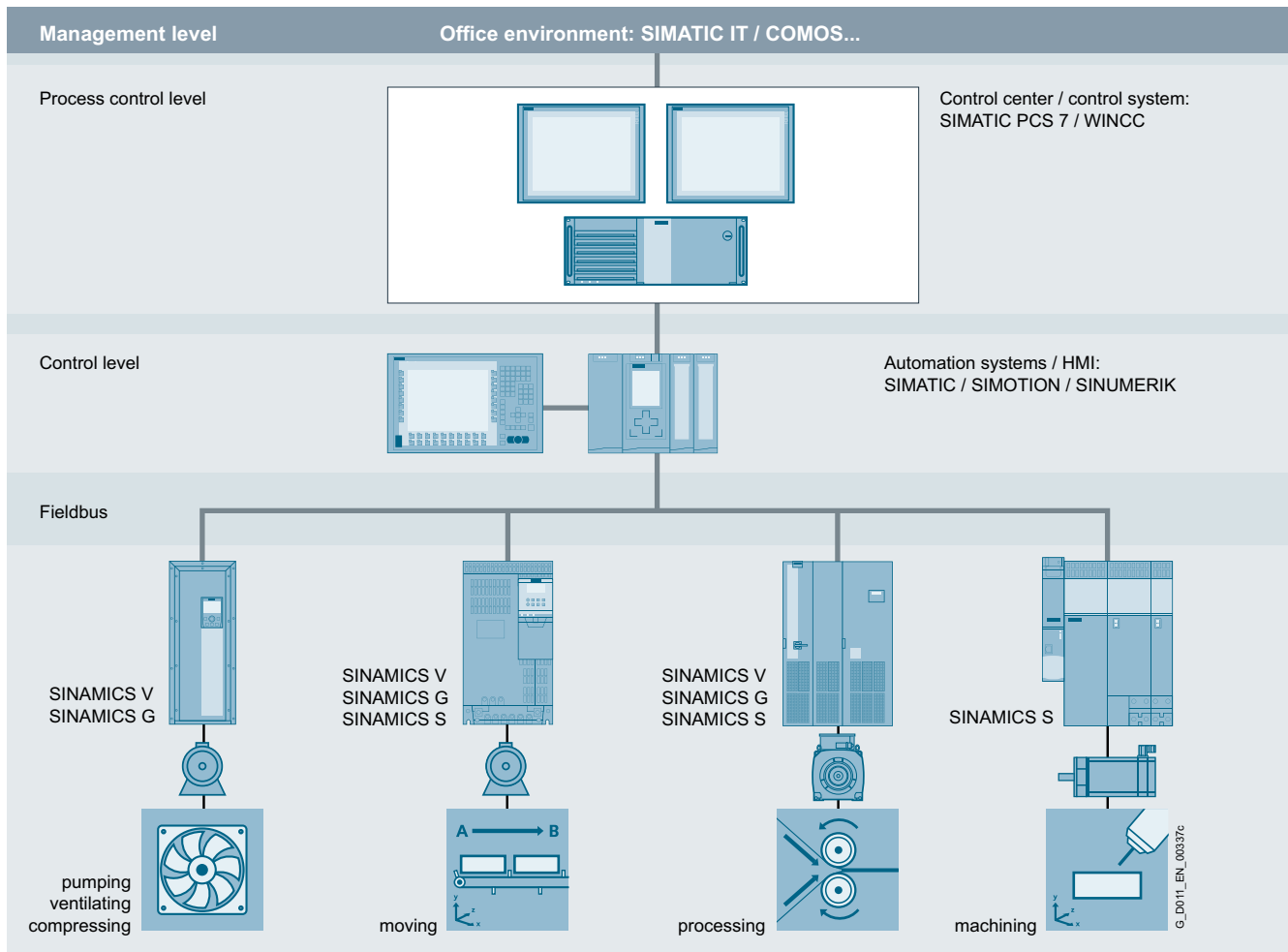

SINAMICS in automation

Totally Integrated Automation and communication

SINAMICS is an integral component of the Siemens "Totally Integrated Automation" concept. Integrated SINAMICS systems covering configuration, data storage, and communication at automation level ensure low-maintenance solutions with the SIMATIC, SIMOTION and SINUMERIK control systems.

Depending on the application, the appropriate variable frequency drives can be selected and incorporated in the automation concept. With this in mind, the drives are clearly subdivided into their different applications. A wide range of communication options (depending on the drive type) are available for establishing a communication link to the automation system:

- PROFINET
- PROFIBUS
- EtherNet/IP
- Modbus TCP
- Modbus RTU
- AS-Interface
- BACnet MS/TP

Applications

SINAMICS is the comprehensive family of drives from Siemens designed for machine and plant engineering applications. SINAMICS offers solutions for all drive tasks:

- Simple pump and fan applications in the process industry
- Demanding single drives in centrifuges, presses, extruders, elevators, as well as conveyor and transport systems
- Drive line-ups in textile, plastic film, and paper machines as well as in rolling mill plants
- Highly dynamic servo drives for machine tools, as well as packaging and printing machines

Overview (continued)



SINAMICS as part of the Siemens modular automation system

Innovative, energy-efficient and reliable drive systems and applications as well as services for the entire drive train

The solutions for drive technology place great emphasis on the highest productivity, energy efficiency and reliability for all torque ranges, performance and voltage classes.

Siemens offers not only the right innovative variable frequency drive for every drive application, but also a wide range of energy-efficient low voltage motors, geared motors, explosion-protected motors and high-voltage motors for combination with SINAMICS.

Furthermore, Siemens supports its customers with global pre-sales and after-sales services, with over 295 service points in 130 countries – and with special services e.g. application consulting or motion control solutions.

System overview

The SINAMICS drive family

Overview (continued)

Energy efficiency

Energy management process

Efficient energy management consultancy identifies the energy flows, determines the potential for making savings and implements them with focused activities.

Almost two thirds of the industrial power requirement is from electric motors. This makes it all the more important to use drive technology permitting energy consumption to be reduced effectively even in the configuration phase, and consequently to optimize plant availability and process stability. With SINAMICS, Siemens offers powerful energy efficient solutions which, depending on the application, enable a significant reduction in electricity costs.

Up to 70 % potential for savings using variable speed operation

SINAMICS enables great potential for savings to be realized by controlling the motor speed. In particular, huge potential savings can be recovered from pumps, fans and compressors which are operated with mechanical throttle and valves. Here, changing to variable-speed drives brings enormous economic advantages. In contrast to mechanical control systems, the power consumption at partial load operation is always immediately adjusted to the demand at that time. So energy is no longer wasted, permitting savings of up to 60 % – in exceptional cases even up to 70 %. Variable-speed drives also offer clear advantages over mechanical control systems when it comes to maintenance and repair. Current spikes when starting up the motor and strong torque surges become things of the past – and the same goes for pressure waves in pipelines, cavitation or vibrations which cause sustainable damage to the plant. Smooth starting and ramp-down relieve the load on the mechanical system, ensuring a significantly longer service life of the entire drive train.

Regenerative feedback of braking energy

In conventional drive systems, the energy produced during braking is converted to heat using braking resistors. Energy produced during braking is efficiently recovered to the supply system by versions of SINAMICS G and SINAMICS S drives with regenerative feedback capability and these devices do not therefore need a braking resistor. This permits up to 60 % of the energy requirement to be saved, e.g. in lifting applications. Energy which can be reused at other locations on a machine. Furthermore, this reduced power loss simplifies the cooling of the system, enabling a more compact design.

Energy transparency in all configuration phases

Early on, in the configuration phase, the SIZER for Siemens Drives engineering tool provides information on the specific energy requirement. The energy consumption across the entire drive train is visualized and compared with different plant concepts.

SINAMICS in combination with energy-saving motors

Engineering integration stretches beyond the SINAMICS drive family to higher-level automation systems, and to a broad spectrum of energy-efficient motors with a wide range of performance classes, which, compared to previous motors, are able to demonstrate up to 10 % greater efficiency.

Overview (continued)**Variants**

Depending on the application, the SINAMICS range offers the ideal variant for any drive task.

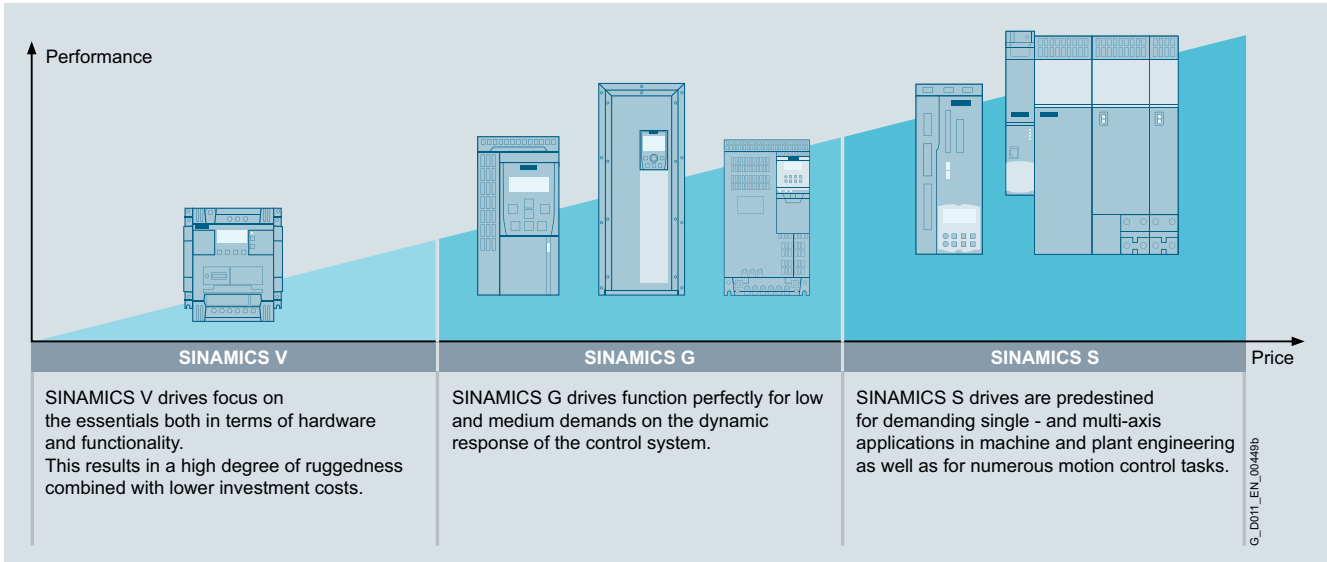
**Platform concept**

All SINAMICS variants are based on a platform concept. Joint hardware and software components, as well as standardized tools for dimensioning, configuration, and commissioning tasks ensure high-level integration across all components. SINAMICS handles a wide variety of drive tasks with no system gaps. The different SINAMICS variants can be easily combined with each other.

Quality management according to EN ISO 9001

SINAMICS conforms to the most exacting quality requirements. Comprehensive quality assurance measures in all development and production processes ensure a consistently high level of quality.

Of course, our quality management system is certified by an independent authority in accordance with EN ISO 9001.

IDS – Integration at its very best













The Siemens Integrated Drive Systems (IDS) solution offers perfectly matched drive components with which you can meet your requirements. The drive components reveal their true strengths as an Integrated Drive System over the full range from engineering and commissioning through to operation: Integrated system configuration is performed using the Drive Technology Configurator: Just select a motor and an inverter and design them with the SIZER for Siemens Drives engineering tool. The STARTER commissioning tool integrates the motor data at the same time and simplifies efficient commissioning. Integrated Drive Systems are incorporated in the TIA Portal – this simplifies engineering, commissioning and diagnostics.

System overview

1

The SINAMICS drive family

Overview (continued)

Low voltage										DC voltage	Medium voltage
Basic performance		General performance					High performance			DC applications	Applications with high outputs
											
SINAMICS V20	SINAMICS V90	SINAMICS G120C G120 G120P G120P Cabinet	SINAMICS G110D G120D G110M SIMATIC ET 200pro FC-2	SINAMICS G130 G150	SINAMICS G180	SINAMICS S110	SINAMICS S210	SINAMICS S120 S120M	SINAMICS S150	SINAMICS DCM	SINAMICS GH150 GH180 GM150 SM150 GL150 SL150 SM120CM
0.12 kW to 30 kW	0.05 kW to 7 kW	0.37 kW to 630 kW	0.37 kW to 7.5 kW	75 kW to 2700 kW	2.2 kW to 6600 kW	0.55 kW to 132 kW	0.05 kW to 0.75 kW	0.55 kW to 5700 kW	75 kW to 1200 kW	6 kW to 30 MW	0.15 MW to 85 MW
Pumps, fans, compressors, conveyor belts, mixers, mills, spinning machines, textile machines, refrigerated display counters, fitness equipment, ventilation systems	Handling machines, packaging machines, automatic assembly machines, metal forming machines, printing machines, winding and unwinding units	Pumps, fans, compressors, conveyor belts, mixers, mills, extruders, building management systems, process industry, HVAC, single-axis positioning applications in machine and plant engineering	Conveyor technology, single-axis positioning applications (G120D)	Pumps, fans, compressors, conveyor belts, mixers, mills, extruders	Sector-specific for pumps, fans, compressors, conveyor belts, extruders, mixers, mills, kneaders, centrifuges, separators	Single-axis positioning applications in machine and plant engineering	Packaging machines, handling equipment, feed and withdrawal devices, stacking units, automatic assembly machines, laboratory automation, wood, glass and ceramics industry, digital printing machines	Production machines (packaging, textile and printing machines, paper machines, plastic processing machines), machine tools, plants, process lines and rolling mills, marine drives, test bays	Test bays, cross cutters, centrifuges	Rolling mill drives, wire-drawing machines, extruders and cableways and lifts, test bay drives	Pumps, fans, compressors, mixers, crushers, mills, extruders, rolling mills, conveyor technology, excavators, test bays, marine drives, blast furnace fans, retrofit
Catalog D 31.1	Brochure V90	Catalogs D 31.1, D 35	Catalog D 31.2	Catalog D 11	Catalog D 18.1	Catalog D 31.1	Catalog D 32	Catalogs D 21.3, D 21.4 NC 62	Catalog D 21.3	Catalog D 23.1	Catalogs D 15.1, D 12

Engineering tools (e.g. Drive Technology Configurator, SIZER for Siemens Drives, STARTER and SINAMICS Startdrive)

G_D011_EN_00450

Application

Use	Requirements for torque accuracy/speed accuracy/position accuracy/coordination of axes/functionality					
	Continuous motion			Non-continuous motion		
	Basic	Medium	High	Basic	Medium	High
Pumping, ventilating, compressing	Centrifugal pumps Radial / axial fans Compressors	Centrifugal pumps Radial / axial fans Compressors	Eccentric screw pumps	Hydraulic pumps Metering pumps	Hydraulic pumps Metering pumps	Descaling pumps Hydraulic pumps
	V20 G120C G120P	G120P G130/G150 G180 ¹⁾	S120	G120	S110	S120
Moving	Conveyor belts Roller conveyors Chain conveyors	Conveyor belts Roller conveyors Chain conveyors Lifting/lowering devices Elevators Escalators/moving walkways Indoor cranes Marine drives Cable railways	Elevators Container cranes Mining hoists Excavators for open-cast mining Test bays	Acceleration conveyors Storage and retrieval machines	Acceleration conveyors Storage and retrieval machines Cross cutters Reel changers	Storage and retrieval machines Robotics Pick & place Rotary index tables Cross cutters Roll feeds Engagers/disengagers
	V20 G110D G110M G120C ET 200pro FC-2 ²⁾	G120 G120D G130/G150 G180 ¹⁾	S120 S150 DCM	V90 G120 G120D	S110 DCM	S120 DCM
Processing	Mills Mixers Kneaders Crushers Agitators Centrifuges	Mills Mixers Kneaders Crushers Agitators Centrifuges Extruders Rotary furnaces	Extruders Winders/unwinders Lead/follower drives Calenders Main press drives Printing machines	Tubular bagging machines Single-axis motion control such as • Position profiles • Path profiles	Tubular bagging machines Single-axis motion control such as • Position profiles • Path profiles	Servo presses Rolling mill drives Multi-axis motion control such as • Multi-axis positioning • Cams • Interpolations
	V20 G120C	G120 G130/G150 G180 ¹⁾	S120 S150 DCM	V90 G120	S110	S120 DCM
Machining	Main drives for • Turning • Milling • Drilling	Main drives for • Drilling • Sawing	Main drives for • Turning • Milling • Drilling • Gear cutting • Grinding	Axis drives for • Turning • Milling • Drilling	Axis drives for • Drilling • Sawing	Axis drives for • Turning • Milling • Drilling • Laser cutting • Gear cutting • Grinding • Nibbling and punching
	S110	S110 S120	S120	S110	S110 S120	S120

The SINAMICS G120P drive is a cost-effective, space-saving drive for pump and fan drives, which is easy to operate and has a wide range of functions. As a consequence, it is especially well-suited for building automation, the process industry, the water industry as well as for heating, ventilation and air conditioning (HVAC).

Specific application examples and descriptions are available on the Internet at

www.siemens.com/sinamics-applications

More information

You may also be interested in these drives:

- More performance in the control cabinet in IP20 degree of protection ⇒ SINAMICS G130, SINAMICS G150
- With positioning function for distributed drive solutions in IP65 degree of protection ⇒ SINAMICS G120D
- With positioning function in the control cabinet in IP20 degree of protection ⇒ SINAMICS S110, SINAMICS S120, SINAMICS S150

¹⁾ Industry-specific drives.

²⁾ Information on SIMATIC ET 200pro FC-2 is available in catalog D 31.2 and at www.siemens.com/et200pro-fc

System overview

SIMOTICS motors

Overview

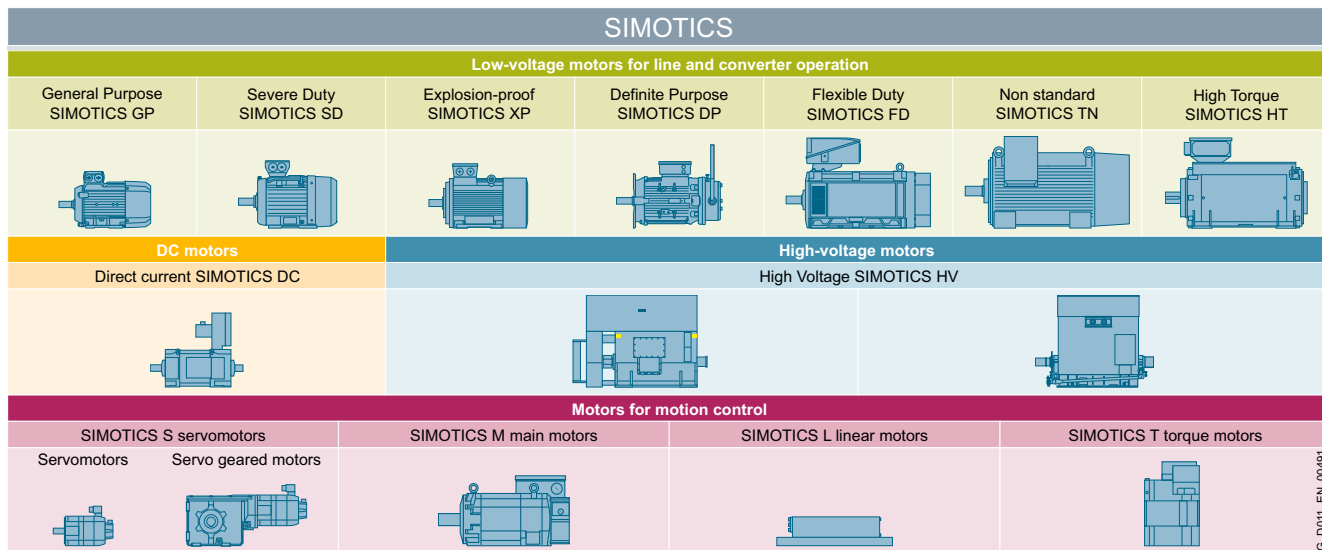

G_D011_EN_00491

SIMOTICS overview

SIMOTICS stands for

- 150 years of experience in building electric motors
- The most comprehensive range of motors worldwide
- Optimum solutions in all industries, regions and power/performance classes
- Innovative motor technologies of the highest quality and reliability
- Highest dynamic performance, precision and efficiency together with the optimum degree of compactness
- Our motors can be integrated into the drive train as part of the overall system
- A global network of skill sets and worldwide service around the clock

A clearly structured portfolio

The entire SIMOTICS product portfolio is transparently organized according to application-specific criteria in order to help users select the optimum motor for their application.

The product range extends from standard motors for pumps, fans and compressors to highly dynamic, precise motion control motors for positioning tasks and motion control in handling applications, as well as production machinery and machine tools, to DC motors and powerful high-voltage motors. Whatever it is that you want to move – we can supply the right motor for the task.

www.siemens.com/simotics

An outstanding performance for any job

A key characteristic of all SIMOTICS motors is their quality. They are robust, reliable, dynamic and precise to assure the requisite performance level for any process and deliver exactly the capabilities demanded by the application in hand. Thanks to their compact design, they can be integrated as space-saving units into installations. Furthermore, their impressive energy efficiency makes them effective as a means of reducing operating costs and protecting the environment.

A dense network of skill sets and servicing expertise around the world

SIMOTICS offers not only a wealth of sound experience gleaned from a development history which stretches back over around 150 years, but also the know-how of hundreds of engineers. This knowledge and our worldwide presence form the basis for a unique proximity to industries which feeds through in tangible terms to the specific motor configuration which is tailored to suit your application.

Our specialists are available to answer all your queries regarding any aspect of motor technology. At any time - wherever you are in the world. When you choose SIMOTICS, therefore, you reap the benefits of a global service network which is continuously accessible, thereby helping to optimize response times and minimize downtimes.

Perfection of the complete drive train

SIMOTICS is perfectly coordinated with other Siemens product families. In combination with the SINAMICS integrated drives family and the SIRIUS complete portfolio of industrial controls, SIMOTICS fits seamlessly as part of the complete drive train into automation solutions which are based on the SIMATIC, SIMOTION and SINUMERIK control systems.

Overview

Step by step to more efficiency

One of the core objectives of the European Union is a sustainable power industry. In industrial plants today, around 70 % of the power demand is from electrically driven systems. This high percentage contains huge potential for saving energy in electrical drives. For that reason, the European Union introduced minimum requirements for the energy efficiency of electric motors in the form of a statutory motor regulation as early as 2011.

However, measures aimed solely at the motor are not enough to achieve the mandatory energy-saving targets. The European legislation fills this gap with the standard series EN 50598 and extends the focus from individual drive components to entire drive systems, even enabling consideration of specific use cases.

The European standard series EN 50598 defines the ecodesign requirements for drive systems in the low-voltage range with an electrically driven machine. It consists of definitions for energy efficiency (parts 1 and 2) and an ecobalance calculation (part 3).

To take account of the different use cases, consideration of eight application-relevant operating points has been introduced as mandatory for the first time. Determination of loss values at these eight points and definition of efficiency classes are laid down by the standard in a uniform way. This enables data relevant to operation, such as application-specific load profiles, to now be taken into account more easily in the energy efficiency analysis.

The standard is especially important for variable-speed drives of the following types:

- for AC/AC converters without energy recovery functionality
- for motors with integrated converters
- for supply voltages of 100 V to 1000 V
- for power ratings of 0.12 kW to 1000 kW

To cover all applications of driven machines, the new standard defines operating points in full-load and partial-load operation, at which the losses of the motor and drive systems have to be determined. Based on the loss data at the operating points in partial-load operation, variable-speed drives can be explicitly considered in more detail. This makes their advantages especially clear.

Centrifugal pumps, fans

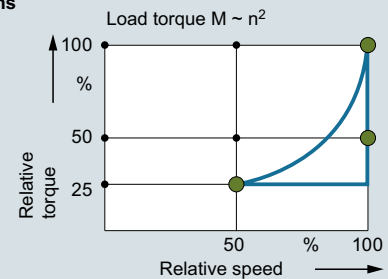

Hoisting gear, extruders, conveyor belts

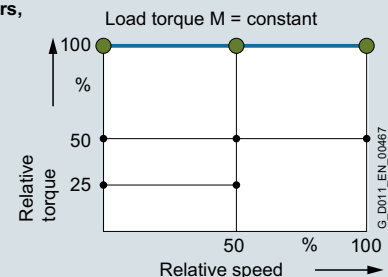

Winders, coilers

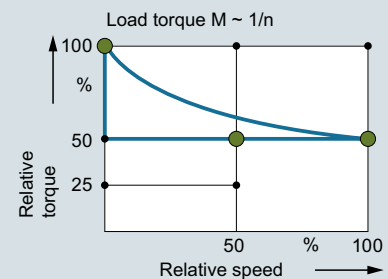

Duty cycles for different driven machines

Moreover, frequency converters and motor systems are classified in efficiency classes, which permit an initial rough estimate of the potential saving. Definition of reference systems is a key aspect of this because they provide standard reference values. The positioning of these reference systems defines the efficiency class. The relative distance from the reference system can be used as an absolute measure of the efficiency at the operating point in question.

System overview

Energy efficiency classes in accordance with EN 50598

1

Overview (continued)

Advantages of the detailed loss consideration of EN 50598 over the previous consideration of efficiencies and maximum loss values

For motors, the efficiency consideration was previously only defined for operation without a converter at 50/60 Hz. It provides a good way of comparing the energy efficiency of motors from different manufacturers for this use case.

The more detailed loss analysis of EN 50598, on the other hand, is aimed at speed-controlled operation and therefore now also includes motors especially designed for converter operation in the energy analysis. These were previously not covered by the applicable standards.

Moreover, a loss analysis over the entire setting and load range of the motor is possible. This is done in accordance with the standard EN 50598 with typical values.

For holistic consideration, it is essential to include all the relevant components of a drive system. The EN 50598 standard defines this in detail. The standardized expression of power loss data as a percentage makes comparison considerably easier and more transparent.

The method also makes it possible to consider a motor that produces a holding torque at speed zero, for example. In this case, the efficiency is zero, but a power loss from current producing magnetization and holding torque does occur. In summary, the key advantage of standard EN 50598 is the ability to perform the energy analysis of an electrical drive system based on standardized load profiles in all operating ranges due to uniform general conditions. This provides the user with complete transparency irrespective of the manufacturer.

Establishing efficiency classes of frequency converters (Complete Drive Modules CDM)

To avoid overmodulation and to ensure comparability between makes, which cannot be achieved otherwise, the efficiency classes of CDMs refer to the 90/100 operating point (90 % motor stator frequency, 100 % torque current).

Standard EN 50598-2 defines the relative losses of a CDM in efficiency classes IE0 to IE2. With reference to the value of a CDM of efficiency class IE1 (reference converter), a CDM of efficiency class IE2 has 25 % lower losses and a CDM of efficiency class IE0 has 25 % higher losses.

Operating points for CDMs

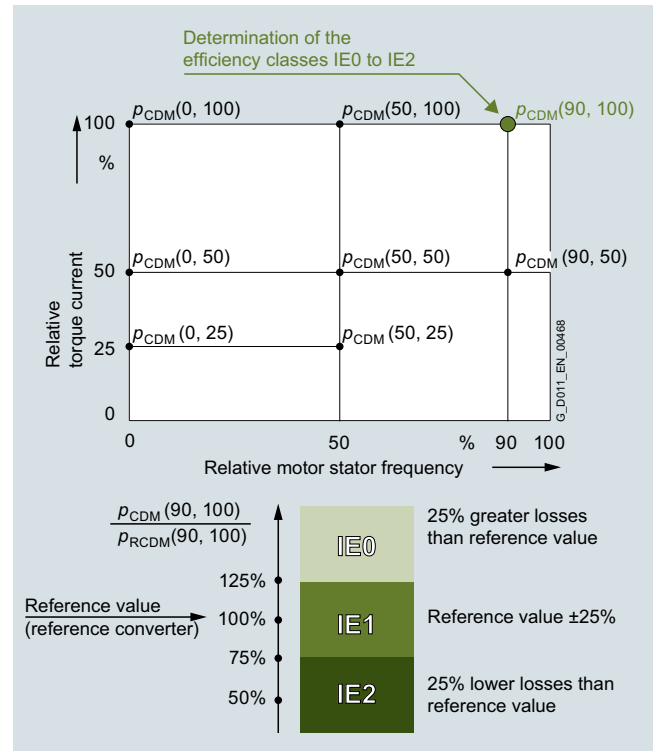

Complete Drive Module (CDM) – determining the efficiency class

Establishing the efficiency classes of drive systems (Power Drive Systems PDS)

What is possible for the individual systems, of course, also applies to the entire electrical PDS (frequency converter plus motor). Detailed comparisons are now possible at this level, too. The reference values for the reference system provide clear indications of the energy performance of the PDS.

Because targeted matching of the motor and CDM provides additional potential for optimization in electrical drive systems, it is especially important for the user to consider the entire drive system.

For the efficiency class of a PDS, too, a specific load point is defined. In this case, the reference point used is the 100/100 operating point (100 % motor stator frequency, 100 % torque).

Standard EN 50598-2 defines the relative losses of a PDS in efficiency classes IES0 to IES2. With reference to the value of a PDS of efficiency class IES1 (reference drive), a PDS of efficiency class IES2 has 20 % lower losses and a PDS of efficiency class IES0 has 20 % higher losses.

Energy efficiency classes in accordance with EN 50598

Overview (continued)

Operating points for PDS

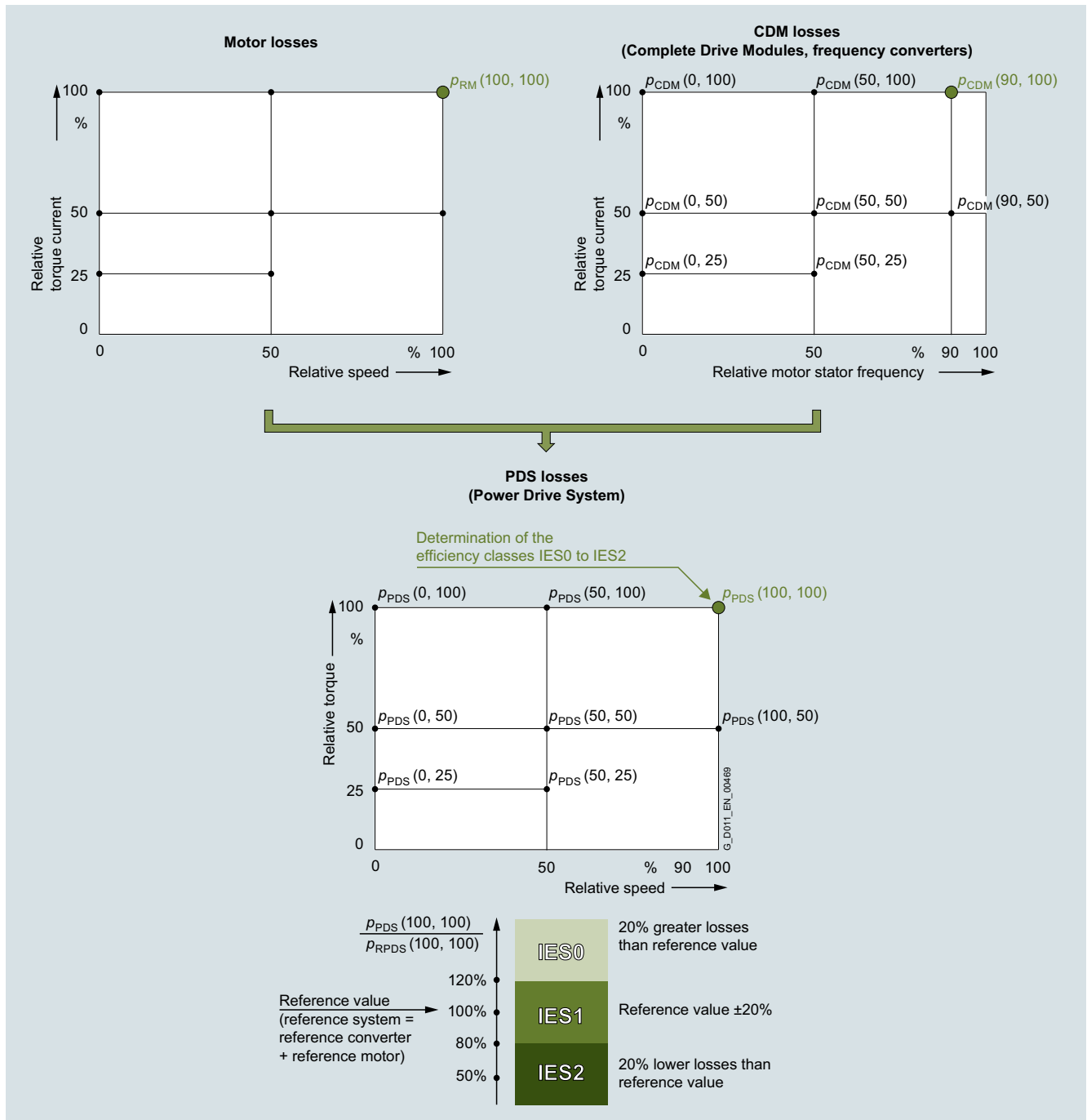

Power Drive System (PDS) – determining the efficiency class

More information

An example of a highly efficient drive system with efficiency class IES2 is the new synchronous inductance drive system with SIMOTICS reluctance motors and SINAMICS drives. More information is available on the Internet at www.siemens.com/drivesystem-reluctance www.siemens.com/simotics-gp www.siemens.com/simotics-sd

Power loss data of SINAMICS converters for single-axis drives are available on the Internet at <https://support.industry.siemens.com/cs/document/94059311> More information on current laws and standards, new standards, and mandatory guidelines is available on the Internet at www.siemens.com/legislation-and-standards

System overview

Notes

1

Communication

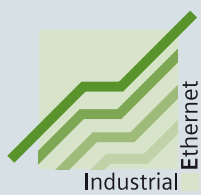

2/2	Communication overview
2/3	PROFINET
2/6	PROFIdrive
2/7	PROFIBUS
2/8	Industrial Ethernet
2/9	EtherNet/IP
2/9	BACnet MS/TP
2/9	Modbus RTU
2/9	USS
2/9	FLN P1

Communication

Communication overview

Overview

Digital bus systems are commonly used in industrial automation today. These handle communication between the control level, the machine control, the sensors and actuators. The SINAMICS product family offers integrated communication interfaces in all product groups – which can be used to connect the most important fieldbus systems in the simplest possible way.

The properties and special application areas of the different bus systems for SINAMICS drives are described briefly below.

Protocol	SINAMICS V		SINAMICS G						SINAMICS S					
	V20	V90	G110	G110D	G120C	G120P/ G120 CU230P-2	G120 CU240E-2	G120 CU250S-2	G110M CU240M	G120D CU240D-2	G120D CU250D-2	S110 CU305	S120 CU310-2 CU320-2	
PROFINET	-	✓	-	-	✓	✓	✓	✓	✓	✓	✓	✓	✓	✓
• PROFINET RT	-	✓	-	-	✓	✓	✓	✓	✓	✓	✓	✓	✓	✓
• PROFINET IRT isochronous	-	✓	-	-	-	-	-	-	-	-	✓	✓	✓	✓
• PROFINET IRT not isochronous	-	✓	-	-	✓	✓	✓	✓	✓	✓	✓	✓	✓	✓
• PROFINET Shared Device	-	-	-	-	✓	✓	✓	✓	✓	✓	✓	✓	✓	✓
• PROFINET media redundancy MRP (non-seamless)	-	-	-	-	✓	✓	✓	✓	✓	✓	✓	✓	✓	✓
• PROFINET media redundancy MRPD (seamless)	-	-	-	-	✓	✓	✓	✓	✓	✓	✓	✓	✓	✓
• PROFI-safe	-	-	-	-	✓	-	✓	✓	✓	✓	✓	✓	✓	✓
• PROFIdenergy	-	-	-	-	✓	✓	✓	✓	✓	✓	-	✓	✓	✓
• PROFIdrive application class 1	-	✓	-	-	✓	✓	✓	✓	✓	✓	✓	✓	✓	✓
• PROFIdrive application class 3	-	✓	-	-	-	-	✓	-	-	✓	✓	✓	✓	✓
• PROFIdrive application class 4	-	✓	-	-	-	-	-	-	-	-	✓	✓	✓	✓
PROFIBUS DP	-	-	-	-	✓	✓	✓	✓	✓	✓	✓	✓	✓	✓
• PROFIBUS DP equidistance and isochronous mode	-	-	-	-	-	-	-	-	-	-	✓	✓	✓	✓
• PROFIBUS DP slave-to-slave communication	-	-	-	-	✓	✓	✓	✓	✓	✓	✓	✓	✓	✓
EtherNet/IP	-	-	-	-	✓	✓	✓	✓	✓	✓	-	-	-	✓
Modbus TCP	-	-	-	-	-	-	-	-	-	-	-	-	✓	✓
Modbus RTU	✓	✓	-	-	✓	✓	✓	✓	-	-	-	-	-	-
AS-Interface	-	-	-	✓	-	-	-	✓	-	-	-	-	-	-
BACnet MS/TP	-	-	-	-	-	✓	-	-	-	-	-	-	-	-
CANopen	-	-	-	-	-	-	✓	-	-	-	-	-	-	✓
USS	✓	✓	✓	✓	✓	✓	✓	✓	-	-	✓	✓	✓	✓
FLN P1	-	-	-	-	-	✓	-	-	-	-	-	-	-	-
Web server	-	-	-	-	-	-	-	-	-	-	-	✓	✓	✓

Overview

**PROFINET – the Ethernet standard for automation**

PROFINET is the world's leading Industrial Ethernet standard for automation with more than 10 million nodes installed worldwide.

PROFINET makes companies more successful, because it speeds up processes and raises both productivity and plant availability.

2

Your advantages at a glance

Flexibility	Efficiency	Performance
Tailor-made plant concepts	Optimal use of resources	Increased productivity
<ul style="list-style-type: none"> ▶ Industrial Wireless LAN ▶ Safety ▶ Flexible topologies ▶ Open standard ▶ Web tools ▶ Expandability 	<ul style="list-style-type: none"> ▶ One cable for everything ▶ Device/network diagnostics ▶ Energy efficiency ▶ Simple wiring ▶ Fast device replacement ▶ Ruggedness/stability 	<ul style="list-style-type: none"> ▶ Speed ▶ High precision ▶ Large quantity structures ▶ High transmission rate ▶ Redundancy ▶ Fast start-up

G_IK10_XX_10304

Flexibility

Short response times and optimized processes are the basic requirements for competitiveness in global markets because the product lifecycles are increasingly becoming shorter.

PROFINET ensures maximum flexibility in plant structures and production processes and enables innovative machine and plant concepts to be implemented. For example, mobile devices can also be integrated at locations that are difficult to access.

Flexible topologies

In addition to the linear structure characterized by the established fieldbuses, PROFINET also enables the use of star, tree and ring structures. This is made possible by the switching technology via active network components, such as Industrial Ethernet switches and media converters, or by integrating switch functionality into the field devices. This creates greater flexibility for the planning of machines and plants, as well as reducing the cabling requirements.

The PROFINET network can be installed without any specialist knowledge at all and meets all requirements that are relevant in the industrial environment. The "PROFINET Installations Guidelines" assist manufacturers and users with network planning, installation and commissioning. Symmetrical copper cables or RFI-resistant fiber-optic cables are used, depending on the application. Devices from different manufacturers are easily connected via standardized and rugged plug connectors (up to IP65/IP67 degree of protection).

By integrating switch functionality into the devices, linear structures can be created that are directly oriented toward an existing machine or plant structure. This reduces cabling overhead and cuts down on components such as external switches.

IWLAN

PROFINET also supports wireless communication with Industrial Wireless LAN, opening up new fields of application. For example, technologies subject to wear, such as trailing cables, can be replaced and the use of automated guided vehicle systems and mobile operator terminals becomes possible.

Safety

The PROFIsafe safety profile, which has been tried and tested with PROFIBUS and which permits the transmission of standard and safety-related data on a single bus cable, can also be used with PROFINET. No special network components are necessary for fail-safe communication, which means that standard switches and standard network transitions can continue to be used without any restrictions. In addition, fail-safe communication is equally possible via Industrial Wireless LAN (IWLAN).

Communication

PROFINET

Overview (continued)

Open standard

PROFINET, the open multi-vendor standard (IEC 61158/IEC 61784), is supported by PROFIBUS and PROFINET International (PI). It stands for maximum transparency, open IT communication, network security and simultaneous real-time communication.

Thanks to its openness, PROFINET provides the basis for a standardized automation network in the plant, to which all other machines and devices can be connected. Even the integration of existing plant components, for example with PROFIBUS, presents no problems due to the use of network transitions.

Use of web tools

Thanks to the unrestricted support of TCP/IP, PROFINET permits the use of standard web services, such as web servers. Irrespective of the tool used, information from the automation level can be accessed from virtually any location using a commercially available Internet browser. This considerably simplifies commissioning and diagnostics. Users can then decide for themselves how much openness to the IT world they want to allow for their machine or plant. This means that PROFINET can be used simply as an isolated plant network or connected via appropriate security modules, such as the SCALANCE S modules, to the office network or the Internet. In this way, new remote maintenance concepts or the high-speed exchange of production data become possible.

Expandability

On the one hand, PROFINET facilitates the integration of existing systems and networks without any great effort or expense. In this way, PROFINET safeguards investments in existing plant components that communicate via PROFIBUS and other fieldbuses such as AS-Interface. On the other hand, additional PROFINET nodes can be added at any time. By using additional network components, network infrastructures can be expanded using cabling or wireless methods – even while the plant is operating.

Efficiency

Greater global competition means that companies must use their resources economically and efficiently. This applies in particular to production. This is where PROFINET ensures greater efficiency. Simple engineering guarantees fast commissioning, while reliable devices ensure a high level of plant availability. Comprehensive diagnostic and maintenance concepts help to reduce plant downtimes and keep maintenance costs to a minimum.

One cable for everything

PROFINET permits simultaneous fieldbus communication with isochronous mode and standard IT communication (TCP/IP) on one cable. This real-time communication for the transmission of the user/process data and diagnostic data takes place on a single cable. Specific profile communication (PROFIsafe, PROFIdrive and PROFlenergy) can be integrated without any additional cabling. This solution offers a wide scope of functions at a low level of complexity.

Device and network diagnostics

By retaining the tried and tested PROFIBUS device model, the same diagnostics information is available with PROFINET. In addition, module- and channel-specific data can also be read out from the devices during device diagnosis, enabling faults to be located quickly and easily. Apart from the availability of device information, the reliability of the network operation has top priority in the network management.

In existing networks the Simple Network Management Protocol (SNMP) has established itself as the de facto standard for the maintenance and monitoring of the network components and their functions. PROFINET uses this standard and gives users the opportunity to maintain their networks with tools that are familiar to them, such as the SINEMA Server network management software.

For easier maintenance of PROFINET devices, both on-site and remotely via a secure VPN connection, application-specific web-sites can be set up on the web server of the field devices using the familiar HTML standard.

Energy efficiency

En route to the green factory: PROFlenergy is a profile that provides functions and mechanisms for PROFINET field devices that support energy-efficient production.

The profile, which is defined by the PNO and is independent of any manufacturers or devices, enables the energy demand and costs to be significantly reduced: Using PROFlenergy, any specific loads that are not currently being used can be switched off. This achieves a noticeable reduction in energy costs during breaks in production. PROFlenergy permits the simple, automated activation and deactivation of technologically related plant components. It is coordinated centrally by means of a higher-level controller and is networked via PROFINET. This ensures that as much energy as possible is saved during longer breaks. Temporarily switching off plant components contributes to the even distribution and most efficient use of energy.

The use of PROFlenergy is made easy for the machine builder by its integration into familiar series of products. In addition, PROFlenergy is defined in such a way that the necessary function blocks can easily be integrated into existing automation systems at a later stage.

Simple wiring

Particularly stringent demands are made on the installation of cabling in the industrial environment. In addition, there is a requirement to set up industry-standard networks in the shortest possible time without any special knowledge.

With FastConnect, Siemens is offering a high-speed installation system that meets all of these requirements. FastConnect is the standard-compliant, industrial cabling system consisting of cables, connectors and assembly tools for PROFINET networks. The time required for connecting terminals is minimized by the simple installation method using just a single tool, while installation errors are prevented by the practical color-coding. Both copper cables and glass fiber optic cables can be easily assembled on site.

Fast device replacement

PROFINET devices are identified by means of a name assigned during configuration. On replacing a defective device, a new device can be recognized from its topology information by the IO controller and a new name can be assigned to it automatically. This means that no engineering tool is necessary for the replacement of equipment.

This mechanism can even be used for the initial commissioning of a complete system. This speeds up commissioning, particularly in the case of series machines.

Ruggedness

An automation network must be robustly protected against external sources of interference. The use of Switched Ethernet prevents faults in one part of the network from affecting the entire plant network. For areas that are particularly prone to radio frequency interference (RFI), PROFINET allows the use of fiber optic cables.

Overview (continued)**Performance**

Productivity and product quality determine the level of success in the market. Precise motion control, dynamic drives, high-speed controllers and the deterministic synchronization of devices are therefore key factors in achieving superior production. They facilitate high production rates and optimum product quality at the same time.

Speed and precision

Fast motion control applications demand precise and deterministic exchange of data. This is implemented by means of drive controllers using isochronous real time (IRT).

With IRT and isochronous mode, PROFINET permits fast and deterministic communication. This synchronizes the various cycles of a system (input, network, CPU processing and output), even in the case of parallel TCP/IP traffic. The short cycle times of PROFINET make it possible to raise the productivity of machines and plants and to guarantee the product quality and high level of precision.

The standardized PROFIdrive profile permits vendor-independent communication between CPUs and drives.

Large quantity structures

The use of PROFINET makes it possible to overcome the existing restrictions regarding the scope of machines and systems that can be implemented. In one network, several different controllers can interact with their assigned field devices. The number of field devices per PROFINET network is virtually unlimited – the entire range of IP addresses is available.

High transmission rate

By using 100 Mbit/s in full duplex mode, PROFINET achieves a significantly higher data rate than previous fieldbuses. This means that other plant data can be transmitted over TCP/IP without any problems, in addition to the process data. PROFINET therefore meets the combined industrial demands for simultaneously transmitting high-speed IO data and large volumes of data for additional sections of the application. Even the transmission of large volumes of data, such as that from cameras, has no adverse effect on the speed and precision of the IO data transmission, thanks to PROFINET mechanisms.

Media redundancy

A higher plant availability can be achieved with a redundant installation (ring topology). The media redundancy can be implemented not only with the aid of external switches, but also by means of integrated PROFINET interfaces. Using the media redundancy protocol (MRP), reconfiguration times of 200 ms can be achieved. If the communication is interrupted in just one part of the ring installation this means that a plant standstill is prevented and any necessary maintenance or repair work can be performed without any time pressure.

For motion control applications, PROFINET with IRT in ring topologies offers the extended media redundancy for planned duplication (MRPD) which operates in a seamless mode without any reconfiguration time. If communication is interrupted (e.g. a cable break) the process can continue operating without interruption.

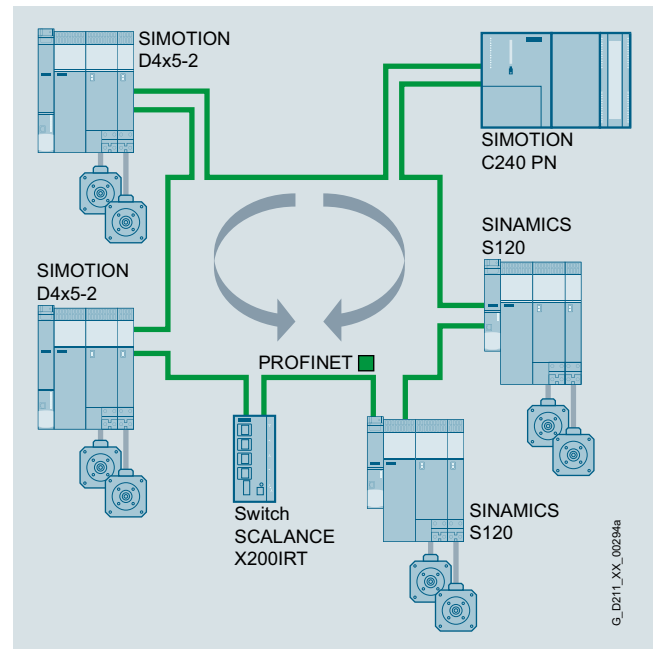

Seamless media redundancy illustrated by example of SINAMICS S120 with SIMOTION and SCALANCE X200IRT

Benefits

- PROFINET is the open Industrial Ethernet standard for automation
- PROFINET is based on Industrial Ethernet
- PROFINET uses TCP/IP and IT standards
- PROFINET is real-time Ethernet
- PROFINET enables seamless integration of fieldbus systems
- PROFINET supports fail-safe communication via PROFI-safe and also via IWLAN

More information

More information is available at www.siemens.com/profinet

Communication

PROFIdrive

Overview



PROFIdrive – the standardized drive interface for PROFINET and PROFIBUS

PROFIdrive defines the device behavior and technique to access internal device data for electric drives connected to PROFINET and PROFIBUS – from basic frequency converters up to high-performance servo controllers.

It describes in detail the practical use of communication functions – slave-to-slave communication, equidistance and clock cycle synchronization (isochronous mode) in drive applications. In addition, it specifies all device characteristics which influence interfaces connected to a controller over PROFINET or PROFIBUS. This also includes the state machine (sequence control), the encoder interface, scaling of values, definition of standard telegrams, access to drive parameters etc.

The PROFIdrive profile supports both central as well as distributed motion control concepts.

What are profiles?

For devices and systems used in automation technology, profiles define properties and modes of behavior. This allows manufacturers and users to define common standards. Devices and systems that comply with such a cross-manufacturer profile, are interoperable on a fieldbus and, to a certain degree, can be interchanged.

Are there different types of profiles?

A distinction is made between what are known as application profiles (general or specific) and system profiles:

- Application profiles (also device profiles) predominantly refer to devices (e.g. drives) and include an agreed selection regarding bus communication as well as also specific device applications.
- System profiles describe classes of systems, including master functionality, program interfaces and integration resources.

Is PROFIdrive fit for the future?

PROFIdrive has been specified by the PROFIBUS and PROFINET International (PI) user organization, and is specified as a standard that is fit for the future through standard IEC 61800-7.

The basic philosophy: Keep it simple

The PROFIdrive profile tries to keep the drive interface as simple as possible and free from technology functions. As a result of this philosophy, referencing models as well as the functionality and performance of the PROFINET/PROFIBUS master have either no influence or only a low influence on the drive interface.

One drive profile – different application classes

The integration of drives into automation solutions depends very strongly on the particular drive application. In order to be able to address the complete, huge bandwidth of drive applications – from basic frequency converters up to synchronized multi-axis systems with a high dynamic performance – using just one profile, PROFIdrive defines six application classes, to which most drive applications can be assigned:

- Class 1 – standard drives (for example pumps, fans, agitators etc.)
- Class 2 – standard drives with technological functions
- Class 3 – positioning drives
- Category 4 - Motion control drives with central, higher-level motion control intelligence and the patented "Dynamic Servo Control" positioning concept
- Category 5 - Motion control drives with central, higher-level motion control intelligence and position setpoint interface
- Category 6 - Motion control drives with distributed motion control intelligence integrated in the drives

Design

The device model of PROFIdrive

PROFIdrive defines a device model based on function modules which cooperate in the device and generate the intelligence of the drive system. These modules have objects assigned to them which are described in the profile and are defined with respect to their functions. The overall functionality of a drive is therefore described through the sum of its parameters.

In contrast to other drive profiles, PROFIdrive defines only the access mechanisms to the parameters as well as a subset of profile parameters (approx. 30) such as the fault buffer, drive control and device identification.

All other parameters are vendor-specific which gives drive manufacturers great flexibility with respect to implementing function modules. The elements of a parameter are accessed acyclically via data records.

As a communication protocol, PROFIdrive uses DP-V0, DP-V1, and the DP-V2 expansions for PROFIBUS including the functions "Slave-to-Slave Communication" and "Isochronous Operation", or PROFINET IO with real-time classes RT and IRT.

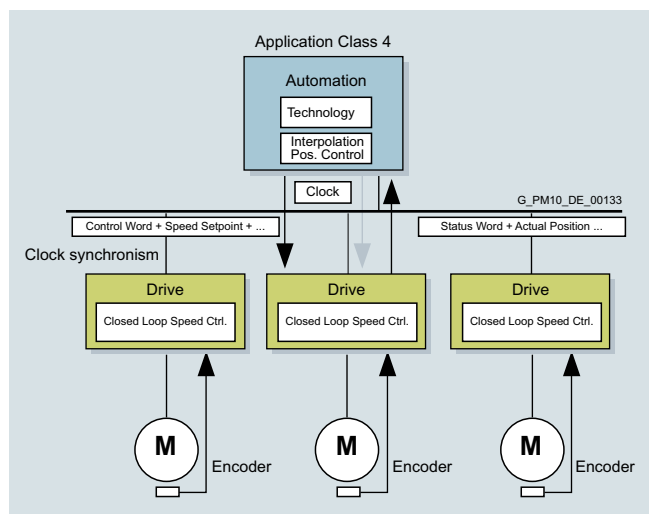

More information

More information on PROFINET and PROFIBUS is available at www.profinet.com

Overview



G_PM10_XX_00144

PROFIBUS – the proven, rugged bus system for automation engineering applications

The requirements of users for an open, non-proprietary communication system have resulted in the specification and standardization of the PROFIBUS protocol.

PROFIBUS defines the technical and functional features of a serial fieldbus system, with which the distributed field automation devices in the lower area (sensor/actuator level) can be networked up to the mid performance range (cell level).

Standardization according to IEC 61158/EN 50170 secures your investments for the future.

Using the conformity and interoperability test performed by the test laboratories authorized by PROFIBUS & PROFINET International (PI) and the certification of the devices by PI, users have the security of knowing that the quality and functionality is guaranteed, even in multi-vendor installations.

PROFIBUS versions

Two different PROFIBUS versions have been defined in order to comply with the widely varying requirements at field level:

- PROFIBUS PA (Process Automation) – the version for applications in process automation. PROFIBUS PA uses the intrinsically safe transmission technology specified in IEC 61158-2.
- PROFIBUS DP (Distributed Periphery) – this version, which is optimized for speed, is specifically tailored to the communication of automation systems with distributed I/O stations and drives. PROFIBUS DP sets itself apart as a result of very short response times and high noise immunity, and replaces cost-intensive, parallel signal transfer with 24 V and measured value transfer utilizing 0/4 ... 20 mA technology.

Design

Bus participants on PROFIBUS DP

PROFIBUS DP makes a distinction between two different master classes and one slave class:

DP master class 1

For PROFIBUS DP, DP master class 1 is the central component. In a defined and continually repeating message cycle the central master station exchanges information with distributed stations (DP slaves).

DP master class 2

Devices of this type (programming, configuring or operator control devices) are used during commissioning, for configuring the DP system, for diagnostics or for operating the active plant or system. A DP master class 2 can, for example, read input, output, diagnostic and configuration data of the slaves.

DP slave

A DP slave is an I/O device which receives output information or setpoints from the DP master, and as response, returns input information, measured values and actual values to the DP master. A DP slave never sends data automatically, but only when requested by the DP master.

The quantity of input and output information depends on the device, and for each DP slave in each send direction can be a maximum of 244 bytes.

Function

Functional scope in DP masters and DP slaves

The functional scope can differ between DP masters and DP slaves. The different functional scopes are classified as DP-V0, DP-V1 and DP-V2.

DP-V0 communication functions

The DP-V0 master functions consist of "Configuration", "Parameter Assignment" and "Reading Diagnostics Data", as well as cyclic reading of input data/actual values and writing output data/setpoints.

DP-V1 communication functions

The DP-V1 function expansions make it possible to perform acyclic read and write functions as well as processing cyclic data communication. This type of slave must be supplied with extensive parameterization data during start-up and during normal operation. These acyclically transferred parameterization data are only rarely changed in comparison to the cyclic setpoints, actual values, and measured values, and are transferred at lower priority in parallel with the cyclic high-speed user data transfer. Detailed diagnostic information can be transferred in the same way.

DP-V2 communication functions

The extended DP-V2 master functions mainly comprise functions for isochronous operation and slave-to-slave communication between DP slaves.

- Isochronous mode:
Isochronous mode is implemented by means of an equidistant signal in the bus system. This cyclic, equidistant clock signal is sent by the DP master to all bus nodes in the form of a global control frame. Master and slaves can then synchronize their applications with this signal. The signal jitter between cycles is less than 1 μ s.
- Slave-to-slave communication:
The "publisher/subscriber" model is used to implement slave-to-slave communication. Slaves declared as publishers make their input data/actual values and measured values available to other slaves, the subscribers, for reading. This is done by sending the response frame to the master as a broadcast. Slave-to-slave communication is therefore a cyclic process.

Integration

PROFIBUS with SINAMICS

SINAMICS uses the PROFIBUS DP protocol. SINAMICS drives can only be used as DP slaves.

Communication

Industrial Ethernet

Overview



Ethernet is the basic Internet technology for worldwide networking. The wide variety of options of Intranet and Internet, that have long been available in the office environment, are now being made available to factory automation with Industrial Ethernet.

Apart from the use of information technology, the deployment of distributed automation systems is also on the increase. This means the breakdown of complex control tasks into smaller, manageable and drive-based control systems. This in turn is boosting the demand for communication which necessitates an extensive and powerful communication system.

Industrial Ethernet provides a powerful area and cell network for the industrial field, compliant with the IEEE 802.3 (ETHERNET) standard.

Benefits

Ethernet enables a very fast data transfer (10/100 Mbit/s, 1/10 Gbit/s) and at the same time has full-duplex capability. It therefore provides an ideal basis for communication tasks in the industrial field. With a share of over 90 %, Ethernet is the number one network worldwide and offers important features which have essential advantages:

- Fast commissioning thanks to extremely simple connection method
- High availability since existing networks can be extended without any adverse effects
- Almost unlimited communication performance because scalable performance is available through switching technology and high data rates when required
- Networking of different application areas such as office and production areas
- Company-wide communication based on wide area network (WAN) technology or the Internet
- Protection of investment due to continuous and compatible development
- Wireless communication using industrial wireless LAN

In order to make Ethernet suitable for industrial applications, considerable expansions with respect to functionality and design are required:

- Network components for use in harsh industrial environments
- Fast assembly of the RJ45 connectors
- Fail-safety through redundancy
- Expanded diagnostics and message concept
- Use of future-oriented network components (e.g. switches)

SIMATIC NET offers corresponding network components and products.

EtherNet/IP

Overview



Ethernet Industrial Protocol (EtherNet/IP) is an open standard for industrial networks. EtherNet/IP is used to transmit cyclic I/O data and acyclic parameter data. EtherNet/IP was developed by Rockwell Automation and the ODVA (Open DeviceNet Vendor Association), and belongs to the international standard series IEC 61158. EtherNet/IP is a popular communication standard, particularly in the American market and in the Rockwell controllers environment.

2

BACnet MS/TP

Overview



BACnet MS/TP (**B**uilding **A**utomation and **C**ontrol **N**etworks **M**aster-**S**lave/**T**oken **P**assing) is another fieldbus system based on the physical characteristics of RS485, which is mainly used in the field of building automation. BACnet MS/TP defines a variety of services including data utilization, alarm processing, event handling, processing of value changes, device and network management, as well as various types of objects. Interoperability is ensured by means of a uniform approach to services and procedures, which is laid down in "application profiles". These profiles are available for a wide range of applications. The SINAMICS G120P converters, especially developed for fluid flow machines (such as pumps, fans and compressor drives), use the application profile "BACnet application-specific controller" in building automation.

Modbus RTU

Overview



As a simple fieldbus protocol, Modbus RTU can be used both cyclically and acyclically. Based on RS485 physical bus characteristics, up to 32 nodes can be networked to one bus segment and connected to a higher-level controller. This protocol is generally used when there are limited demands on data throughput.

USS

Overview

As a simple fieldbus protocol, USS (**U**niversal **S**erial **I**nterface protocol of Siemens AG, 1992) can be used both cyclically and acyclically. Based on RS485 physical bus characteristics,

up to 32 nodes can be networked to one bus segment and connected to a higher-level controller. This protocol is generally used when there are limited demands on data throughput.

FLN P1

Overview

P1 is an asynchronous master-slave communication between what is known as a Field Cabinet (master) and the FLN devices (slaves). FLN stands for **F**loor **L**evel **N**etwork. The master individually addresses the various slaves. A slave responds only if the master addresses it. Communication between the slaves is not possible.

A Field Cabinet can have several FLN ports. Up to 32 FLN devices (slaves) can be connected to each FLN port.

Communication

Notes

2

System configuration



3/2 SINAMICS G120P and SINAMICS G120P Cabinet pump, fan, compressor converters

- 3/2 Overview
- 3/4 Benefits
- 3/5 Application
- 3/6 Design
- 3/7 Function
- 3/8 Configuration
- 3/9 Technical specifications
- 3/15 Accessories

3/16 Integrated Drive Systems

- 3/16 Overview

System configuration

SINAMICS G120P and SINAMICS G120P Cabinet pump, fan, compressor converters

SINAMICS G120P and SINAMICS G120P Cabinet pump, fan, compressor converters

Overview

Easy handling, productivity and energy efficiency – Siemens offers an answer to these trends with the SINAMICS G120P series. SINAMICS G120P is an innovative and user-friendly converter series that has been specifically optimized for pump, fan and compressor applications in the industrial environment, but also for tasks in building automation.

SINAMICS G120P offers efficient drive solutions for a wide range of applications. With their easy handling, the drives support the user not only in optimizing existing frequency-controlled drives, but also in converting fixed-speed drives and in retrofitting.

The SINAMICS G120P converter series features advanced hardware and software functions that make a substantial contribution towards saving energy and thus make more careful use of our natural resources.

3



SINAMICS G120P in degree of protection IP20, PM230 Power Module, frame size FSB



SINAMICS G120P in degree of protection IP20, PM240P-2 Power Module, frame size FSD



SINAMICS G120P in degree of protection IP20, PM330 Power Module, frame size GX



SINAMICS G120P in degree of protection IP20, PM230 Power Module, frame size FSC Push Through (with Control Unit and BOP-2 operator panel)

Overview (continued)



SINAMICS G120P in degree of protection IP55, PM230 Power Module, frame size FSB



SINAMICS G120P Cabinet converter cabinet units, versions A and C

User-friendliness

A high degree of user-friendliness is one of the main characteristics of the SINAMICS G120P:

- Operator panel with color display and extensive diagnostics functions (IOP-2)
- Simple application-specific commissioning wizard "on board" the Intelligent Operator Panel (IOP-2)
- Plain text scripts for integration in the STARTER commissioning tool for more demanding applications
- SINAMICS SD card for storing parameter settings, cloning and local commissioning

Guided operation using wizards

SINAMICS G120P offers two basic options for guided parameterization/setting in a target application:

Commissioning simple applications

using application wizards optionally available in the IOP-2 operator panel.¹⁾

The following wizards are available:

- Basic commissioning
- Pump with/without PID control
- Fan with/without PID control
- Compressor with/without PID control
- PID setting
- Boost setting

An appropriate connection diagram for the standard wiring can be found in the documentation of the IOP-2 operator panel.

Commissioning of more demanding applications

using plain text scripts through solution-based dialog prompting in the STARTER commissioning tool

The wizards support setpoint input for process values and setpoint exchanges using timers. They also allow easy integration of technological functions, such as cascade connection or hibernation mode. The connection diagrams for standard wiring that are required for the wizards are also supplied.

The following wizards are available:

- Fan for exhaust air with closed-loop control of pressure/air quality
- Fan for cooling tower with closed-loop control of cooling water temperature
- Fan for stairwell with closed-loop control of pressure and essential service mode
- Fan for tunnel/parking garage with closed-loop control of air quality and essential service mode
- Fan for supply air with closed-loop control of pressure/temperature/air quality/flowrate
- Pumps with closed-loop control of pressure
- Pumps with closed-loop control of level
- Pumps for cooling circuits with closed-loop control of temperature
- Compressor with closed-loop control of pressure

¹⁾ Further information is available on the Internet at <https://support.industry.siemens.com/cs/document/67273266>

System configuration

SINAMICS G120P and SINAMICS G120P Cabinet pump, fan, compressor converters

SINAMICS G120P and SINAMICS G120P Cabinet pump, fan, compressor converters

Benefits

Energy efficiency

SINAMICS G120P increases the efficiency and minimizes energy consumption in the complete process chain. The converter has integrated hardware as well as software functions as standard. The main features are:

- PM230 Power Modules up to 90 kW: Extremely high active power component of apparent power thanks to efficient converter topology. For the same drive power, the converter requires a lower line current than comparable converters
- Flux reduction through automatic adaptation of the motor current to the prevailing load conditions with closed-loop control modes U/f (ECO) and vector without sensor (SLVC) and savings of up to 5 % under partial load conditions
- Hibernation mode dependent on setpoints in the process
- Automatic switchover to line operation is possible at rated speed (bypass mode)

Optimum energy management through innovative technology

Optimized converter topology for PM230 Power Modules

- Compliance with limits for line harmonic distortion in accordance with EN 61000-3-12 ($R_{SCE} > 250$) without a line reactor
- Reduced apparent power as a result of high power factor $\lambda = 0.9$
- Smaller cable cross-sections can be used because mains power consumption is reduced

Flux reduction

- Energy-saving capability through automatic adaptation of the magnetic flux in the motor to prevailing load conditions (lower motor losses under partial load conditions)

Hibernation mode

- Energy-saving capability: The drive is started/stopped in line with the currently applicable setpoints, thereby avoiding excessive mechanical loads

High efficiency

- $\eta \geq 98$ % with PM330 Power Module
- $\eta > 97$ % with PM240P-2 Power Module
- $\eta \leq 97$ % with PM230 Power Module

Straightforward, application-specific commissioning and operation using operator panel

- Local commissioning without specialized knowledge of converters using application-specific wizards
- Unique: SINAMICS SD memory card for pre-parameterization and cloning of converter data sets
- Data backup for easy replacement
- USB port integrated on the CU230P-2 Control Unit for commissioning and easy diagnostics using the STARTER commissioning tool
- Commissioning/diagnostics and controlling of converters

Flexible deployment of integrated functions

- PLC functions for local control tasks
Flexible use of integrated function blocks → No need for additional, external components
- 4 integrated PID controllers
Distributed closed-loop control for motor-independent process control without higher-level controller (PLC)
- 3 freely programmable digital timer switches
Control for freely selectable daily and weekly programs

Flexible deployment across a wide range of applications

- Isolated digital inputs with separate potential group
- Isolated analog inputs
 - Potential transfer avoided
 - EMC-compliant design without the need for additional components in line with process industry requirements
- Pt1000/LG-Ni1000/DIN-Ni1000 temperature sensor interface
 - Direct connection of temperature sensors without external interface unit
- 230 V AC relay
 - Direct control for auxiliary equipment, e.g. reactor or valve actuators
- Safety functions
 - PM230 Power Modules, frame sizes FSA to FSC:
In conjunction with the CU240E-2 Control Unit ¹⁾
Control of the STO safety function acc. to SIL 2
 - PM240P-2 Power Modules: Terminals for controlling STO and SS1 safety functions acc. to SIL 3
 - PM330 Power Modules: Terminals for controlling STO and SS1 safety functions ²⁾ acc. to SIL2 and SIL 3
- Terminal strip X9 at PM330 Power Module
 - Input for external 24 V DC supply
 - Input for external alarm/fault
 - Input for EMERGENCY OFF/EMERGENCY STOP
 - Output for DC 24 V
 - Control of the main contactor
 - Feedback message "DC link charged"

Flexible, modular system for challenging environmental conditions

- Operation possible at ambient temperatures of up to +60 °C
- Modular design of power and control electronics
 - Power range can be easily extended
 - Fast exchange of power units
- Removable operator panel for built-in and wall-mounted units
 - Protection against unauthorized access
 - Degree of protection IP55/UL type 12 with IOP-2, BOP-2 operator panel or blanking cover
 - Degree of protection IP20 with IOP-2, BOP-2 operator panel or blanking cover
 - Degree of protection IP20 Push Through variant with IOP-2, BOP-2 operator panel or blanking cover
- Replacement of individual components without the need for reinstallation

¹⁾ More information on the CU240E-2 Control Unit is available in Catalog D 31.1, Chapter SINAMICS G120.

²⁾ The Safety functions are available from functional status FS 04 of the Power Modules.

Application***The specialist for pump, fan and compressor applications***

SINAMICS G120P is ideally suited to pump applications (centrifugal pumps, oscillating and rotating pumps), fan applications (axial and radial fans) and compressor applications (cooling compressors, air and gas compressors). They are deployed in industrial environments, in the process industry and water industry and in building automation.

SINAMICS G120P is ideally suited for the following applications:

- Circulating pumps for heating and cooling systems
- Pumps for pressure boosting stations
- Level control
- Fans in cooling towers
- Fans for air intake and discharge
- Fans for tunnels and multi-storey car parks
- Fans for stairwells
- Compressors for supplying compressed air

Reliable operation in harsh environments

SINAMICS G120P is suitable for use under harsh environmental conditions:

- High degree of protection IP55 for installation outside the control cabinet
- Degree of protection IP20 for use in the control cabinet
- Degree of protection IP20 Push Through variant for space-saving design when installed in the control cabinet; power losses are dissipated using an external heat sink, separate internal air circulation
- Operation possible at ambient temperatures of up to 60 °C (140 °F)
- Coated modules for increased resistance to humidity and dust

System configuration

SINAMICS G120P and SINAMICS G120P Cabinet pump, fan, compressor converters

SINAMICS G120P and SINAMICS G120P Cabinet pump, fan, compressor converters

Design

SINAMICS G120P is a modular converter system comprising the following components.

- CU230P-2 Control Unit
- Power Module
- Operator panel or blanking cover

CU230P-2 Control Unit

The converter communication interface is defined when selecting the Control Unit (FW V4.5 and higher).

- CU230P-2 HVAC → USS, Modbus RTU, BACnet MS/TP, FLN P1
- CU230P-2 DP → PROFIBUS
- CU230P-2 PN → PROFINET, EtherNet/IP

The CU230P-2 Control Unit controls and monitors the Power Module and the connected motor using several different closed-loop control modes that can be selected. It supports communication to a local or central controller as well as to the monitoring equipment, and allows all process-related auxiliary equipment and external components to be connected (sensors, valves, contactors, etc.).

Power Modules

The Power Module is selected depending on the power requirement and the application. State-of-the-art IGBT technology with pulse-width modulation is used for reliable and flexible motor operation. Comprehensive protection functions provide a high degree of protection for the Power Module and the motor.

Power Modules for use in building technology for heating, air conditioning and ventilation applications

The Power Modules in degree of protection IP20 are intended for installation in a control cabinet:

- PM230 with integrated filter class A, 0.37 kW to 75 kW
- PM230 without integrated line filter, 0.37 kW to 75 kW
- PM230 with integrated filter class A, Push Through variant, 3 kW to 18.5 kW
- PM230 without integrated line filter, Push Through variant, 3 kW to 18.5 kW

The Power Modules in degree of protection IP55 can be erected as distributed units outside a control cabinet.

- PM230 with integrated filter class A, degree of protection IP55/UL type 12, 0.37 kW to 90 kW
- PM230 with integrated filter class B, degree of protection IP55/UL type 12, 0.37 kW to 90 kW

Power Modules for use in the water/wastewater sector as well as in industrial applications

The Power Modules in degree of protection IP20 are intended for installation in a control cabinet:

Line voltage 380 V to 480 V 3 AC

- PM240P-2 with integrated filter class A, 22 kW to 132 kW
- PM240P-2 without integrated line filter, 22 kW and 132 kW
- PM330 without integrated line filter, 160 kW to 560 kW

Line voltage 500 V to 690 V 3 AC

- PM240P-2 with integrated filter class A, 11 kW to 132 kW
- PM240P-2 without integrated line filter, 11 kW and 132 kW
- PM330 without integrated line filter, 315 kW to 630 kW

SINAMICS G120P Cabinet

SINAMICS G120P units rated for outputs of 75 kW and higher are also available in the control cabinet version SINAMICS G120P Cabinet for line voltages of 380 V to 480 V 3 AC and 500 V to 690 V 3 AC.

- SINAMICS G120P Cabinet, degrees of protection IP20/IP21/IP23/IP43/IP54, 75 kW to 630 kW, with and without line filter

Operator panel or blanking cover

- Intelligent Operator Panel IOP-2, degree of protection IP55/UL type 12
The IOP-2 supports entry-level personnel as well as drive experts. Thanks to the large plain text display, the menu-based operation and the application wizards, it is easy to commission, diagnose and locally control standard drives. Optionally available wizards ¹⁾ interactively guide users through the commissioning process.
- Basic Operator Panel BOP-2, degree of protection IP55/UL type 12
The menu prompting and the 2-line display allow for the fast and user-friendly commissioning of the converter. Simultaneous display of the parameter and parameter value, as well as parameter filtering, means that basic commissioning of a drive can also be performed without a printed parameter list.
- Blanking cover, degree of protection IP55/UL type 12
The blanking cover is mounted on the Power Module in place of an operator panel, provided that an operator panel is not required.

The operator panel supports user-friendly local commissioning, control and diagnostics and enables complete converter data sets to be pre-parameterized and cloned.

Note for PM230 Power Modules, degree of protection IP55/UL type 12

It is essential to plug on an operator panel or the blanking cover in order to achieve degree of protection IP55.

Line-side power components

The following line-side power components are available for the SINAMICS G120P converters:

- Line filters for PM230 and PM330 Power Modules and SINAMICS G120P Cabinet
With an additional line filter, the Power Module complies with a higher radio interference class.
- Line reactors for PM330 Power Modules and SINAMICS G120P Cabinet
Line reactors smooth the current drawn by the converter and thus reduce harmonic components in the line current. Through the reduction of the current harmonics, the thermal load on the power components in the rectifier and in the DC link capacitors is reduced as well as the harmonic effects on the supply. The use of a line reactor increases the service life of the converter.
SINAMICS G120P Cabinet units feature a cabinet-integrated line-side reactor as standard.

Note:

A line reactor must not be used in combination with a PM230 Power Module.

Recommended line-side overcurrent protection devices and power components

This section contains recommendations for additional line-side components, such as Siemens fuses and circuit breakers (line-side components must be dimensioned in accordance with IEC standards).

Additional information about the listed fuses and circuit breakers is available in Catalogs LV 10, IC 10 and IC 10 AO as well as in the Industry Mall..

¹⁾ More information is available on the Internet at <https://support.industry.siemens.com/cs/document/67273266>

Design (continued)**DC link components**

The following DC link components are available for the SINAMICS G120P converters:

- Braking Module for PM330 Power Modules and SINAMICS G120P Cabinet
A Braking Module and the matching braking resistor are required to achieve controlled braking of a drive. The Braking Module houses the power electronics and the associated control circuit.
- Braking resistors for PM330 Power Modules and SINAMICS G120P Cabinet
Excess energy in the DC link is dissipated via the braking resistor.

Load-side power components

Various load-side power components are available for the SINAMICS G120P converters. These allow the use of longer shielded motor cables and increase the motor service life:

- Output reactors
Output reactors reduce the rate of voltage rise (dv/dt) and the height of the current peaks, and enable longer motor cables to be connected.
- Sine-wave filters for PM230 Power Modules
Sine-wave filters limit the rate of voltage rise (dv/dt) and the peak voltages on the motor winding. Similar to an output reactor, they enable the connection of longer motor cables.
- dv/dt filters plus VPL for PM240P-2 and PM330 Power Modules
 dv/dt filters plus VPL (Voltage Peak Limiter) limit the voltage rate-of-rise dv/dt to values $<500\text{ V}/\mu\text{s}$ and the typical voltage peaks to values according to the limit value curve as per IEC/TS 60034-17: 2006.
Standard motors with standard insulation and without insulated bearings can be used for converter operation if a dv/dt filter plus VPL is used.
- dv/dt filters compact plus VPL for PM330 Power Modules and SINAMICS G120P Cabinet
 dv/dt filters compact plus VPL (Voltage Peak Limiter) limit the voltage rate-of-rise dv/dt to values of $<1600\text{ V}/\mu\text{s}$ and the typical voltage peaks to values according to the limit value curve A to IEC 60034-25: 2007.
Standard motors with standard insulation and without insulated bearings can be used for converter operation if a dv/dt filter compact plus VPL is used.

Optional accessories

- Line-side cable connection, left, for PM330 Power Modules
- Push Through mounting frame for PM230 Power Modules
- SINAMICS memory card (SD card)
- PC inverter connection kit 2
- Shield connection kits for CU230P-2 Control Units (for PM230 and PM240P-2 Power Modules)
- Shield connection kits and shield plates for PM230 and PM240P-2 Power Modules

Spare parts

- Spare part kit for Control Units
- Shield connection kits for PM240P-2 Power Modules
- Shield plates for PM230 Power Modules
- Mounting set for PM230 Power Modules
- Terminal Cover Kit for PM230 Power Modules
- Fan units and replacement fans

Function**Technology function**

Functions specific to pumps, fans and compressors are already integrated, e.g.:

- **Automatic restart**
Application restart after a power failure or fault occurrence
- **Flying restart**
Connection of the converter when the motor is running
- **Flux reduction**
Automatic adaptation of the motor current to the prevailing load conditions in U/f control mode (ECO mode) as well as in sensorless vector control mode
- **Cascade connection**
Load-dependent connection and disconnection of a maximum of three additional motors by the converter in order to provide a largely constant output power (implemented by means of an additional external circuit)
- **Hibernation mode**
Startup or shutdown of the drive when the relevant value drops below an external setpoint or the internal PID controller setpoint
- **Real-time clock**
For time-dependent process controls, e.g. to reduce the temperature of a heating control at night and with automatic daylight saving/standard time switchover
- **Freely programmable logical function blocks**
For simulating simple PLC functions

Functions especially for building technology as well as heating/air conditioning/ventilation applications

- **4 integrated PID controllers**
One PID controller for controlling the drive speed as a function of pressure, temperature, flowrate, fill level, air quality and other process variables, and a further three PID controllers with freely configurable outputs, e.g. for controlling valves (heating, cooling) or flaps
- **Emergency mode**
Special converter operating mode that enhances the availability of the drive system in the event of a fire
- **Multi-zone controller**
 - Closed-loop control of a zone with up to 3 sensors for pressure or temperature, or
 - Closed-loop control of two independent zones, each with one sensor
- **Bypass mode**
When the setpoint is reached or a fault occurs, the system changes over to line operation (implemented by means of an additional external circuit)
- **Programmable time switches**

System configuration

SINAMICS G120P and SINAMICS G120P Cabinet pump, fan, compressor converters

SINAMICS G120P and SINAMICS G120P Cabinet pump, fan, compressor converters

Configuration

The following electronic configuring guides and engineering tools are available for SINAMICS G120P converters:

SinaSave energy efficiency tool

Use SinaSave to calculate potential energy savings

The web-based tool SinaSave can be used to estimate the potential savings which can be achieved over the entire lifecycle, e.g. for pump and fan applications, thanks to SINAMICS. The tool takes into consideration all important plant-specific quantities, such as the power and load data of the application, the relevant control mode and the operation profile for the application in question. The result delivered by the tool specifies the potential energy savings which can be achieved with the specific application in conjunction with the Integrated Drive System or the drive component. The tool also provides a monetary evaluation of the potential savings and estimates the payback period.

Drive Technology Configurator (DT Configurator)

Drive Technology Configurator (DT Configurator) within the CA 01

The interactive catalog CA 01 – the offline Industry Mall of Siemens on DVD-ROM – contains over 100 000 products with approximately 5 million possible drive system product variants. The Drive Technology Configurator (DT Configurator) has been developed to facilitate selection of the correct motor and/or converter from the wide spectrum of drives. It is integrated as a selection tool in Catalog CA 01.

Online DT Configurator

In addition, the DT Configurator can be used on the Internet without requiring any installation. The DT Configurator can be found in the Siemens Industry Mall at the following address:

www.siemens.com/dt-configurator

SIZER for Siemens Drives engineering tool

Configuring made simple and systematic

The SIZER for Siemens Drives engineering tool is used to configure low-voltage drive systems: Using the application as the prime reference, this tool provides step-by-step support in defining the mechanical system and designing converters, motors and gear units. It also helps the user to configure other system components and to design open-loop and closed-loop control functions. In addition to engineering results such as characteristics, technical specifications and installation and dimensional drawings, SIZER for Siemens Drives also provides calculations pertaining to performance and load-dependent power requirements.

SIZER WEB ENGINEERING engineering tool

Drive engineering – flexible, customized and user-friendly

A solution for a drive task can be identified quickly with the web-based tool: menu-prompted workflows guide the user through the technical selection and dimensioning of products and drive systems, including the accessories.

Based on an integrated inquiry functionality, SIZER WEB ENGINEERING also offers you special customized solutions for applications which cannot be addressed using "Standard Products"; i.e. the focus is on flexibility and customized solutions.

Comprehensive documentation, such as data sheets, startup calculations, dimensional drawings, offer documentation and a lot more are integrated in the tool. The result: Customized solutions for any drive task.

The product groups supported are:

- High-voltage motors
- Low-voltage motors
- Medium-voltage converters
- Low-voltage converters
- DC converters

The tool can also be used to design the following drive systems:

- Medium-voltage systems
- Low-voltage systems
 - Basic single-axis applications for pumps, fans, and compressors
 - Complex applications (on condition that: SIZER for Siemens Drives is installed)

STARTER commissioning tool

Commissioning and diagnostics – intelligent and easy

The STARTER commissioning tool allows menu-prompted commissioning, optimization and diagnostics. Apart from the SINAMICS drives, STARTER is also suitable for MICROMASTER 4 devices.

SINAMICS Startdrive commissioning tool

SINAMICS engineering in the TIA Portal

SINAMICS Startdrive is a tool for configuring, commissioning, and diagnosing the SINAMICS family of drives and is integrated into the TIA Portal. SINAMICS Startdrive can be used to implement drive tasks with the SINAMICS G120, SINAMICS G120C, SINAMICS G110M, SINAMICS G120D and SINAMICS G120P drives. The commissioning tool has been optimized with regard to user-friendliness and consistent use of the TIA Portal benefits of a common working environment for PLC, HMI and drives.

Drive ES engineering system

Drive ES is the engineering system that can be used to integrate the communication, configuration and data management functions of Siemens drive technology into the SIMATIC automation world easily, efficiently and cost-effectively. Two software packages are available for SINAMICS – Drive ES Basic and Drive ES PCS 7.

You can find further information about the Drive ES engineering system in the chapter [Engineering Tools](#).

Additional information about the Drive ES engineering system is available on the internet at

www.siemens.com/drive-es

Technical specifications

Unless explicitly specified otherwise, the following technical specifications are valid for all the following components of the

SINAMICS G120P and SINAMICS G120P Cabinet pump, fan, compressor converters.

Mechanical specifications

Vibratory load

- Storage according to EN 60721-3-1	
- Drives and components, frame sizes FSA to FSF	Class 1M2 Deflection: 1.5 mm at 5 ... 9 Hz Acceleration: 0.5 × g at 9 ... 200 Hz
- Drives and components, frame sizes GX to JX	Class 1M2 Deflection: 1.5 mm at 5 ... 9 Hz Acceleration: 0.5 × g at 9 ... 200 Hz
- SINAMICS G120P Cabinet	Class 1M2 Deflection: 1.5 mm at 5 ... 9 Hz Acceleration: 0.5 × g at 9 ... 200 Hz
• Transport ¹⁾ acc. to EN 60721-3-2	
- Drives and components, frame sizes FSA to FSC ²⁾	Class 2M2
- Drives and components, frame sizes FSD to FSF ²⁾	Class 2M3
- Drives and components, frame sizes GX to JX	Test FC according to EN 60068-2-6 Deflection: ±1.5 mm at 5 ... 9 Hz Acceleration: 0.5 × g at 9 ... 200 Hz
- SINAMICS G120P Cabinet	Class 2M2
• Operation acc. to EN 60721-3-3	
- Drives and components, frame sizes FSA to FSF	Class 3M1
- Drives and components, frame sizes GX to JX	Test FC according to EN 60068-2-6 Deflection: 0.075 mm at 10 ... 58 Hz Acceleration: 10 m/s ² (1 × g) at 58 ... 200 Hz
- SINAMICS G120P Cabinet	Class 3M2

Shock load

• Storage according to EN 60721-3-1	
- Drives and components, frame sizes FSA to FSF	Class 1M2
- Drives and components, frame sizes GX and JX	Test FC according to EN 60068-2-6 Deflection: ±1.5 mm at 5 ... 9 Hz Acceleration: 0.5 × g at 9 ... 200 Hz
- SINAMICS G120P Cabinet	Class 1M2 Acceleration: 40 m/s ² (4 × g) at 22 ms
• Transport ¹⁾ acc. to EN 60721-3-2	
- Drives and components, frame sizes FSA to FSC ²⁾	Class 2M2
- Drives and components, frame sizes FSD to FSF ²⁾	Class 2M3
- Drives and components, frame sizes GX to JX	Test FC according to EN 60068-2-6 Deflection: ±1.5 mm at 5 ... 9 Hz Acceleration: 0.5 × g at 9 ... 200 Hz
- SINAMICS G120P Cabinet	Class 2M2
• Operation acc. to EN 60721-3-3	
- Drives and components, frame sizes FSA to FSC	Class 3M2
- Drives and components, frame sizes FSD to FSF	Class 3M1
- Drives and components, frame sizes GX and JX	Test Ea according to EN 60068-2-27 Acceleration: 49 m/s ² (5 × g) at 30 ms or 147 m/s ² (15 × g) at 11 ms
- SINAMICS G120P Cabinet	Class 3M2

Deviations from the specified classes are underlined.

¹⁾ In transport packaging.

²⁾ In product packaging.

System configuration

SINAMICS G120P and SINAMICS G120P Cabinet pump, fan, compressor converters

SINAMICS G120P and SINAMICS G120P Cabinet pump, fan, compressor converters

Technical specifications (continued)

Ambient conditions	
Protection class According to EN 61800-5-1	Class I (with protective conductor system) and class III (PELV)
Touch protection	According to EN 50274 and DGUV Regulation 3 when used for the intended purpose
Permissible ambient and coolant temperature (air) during operation for line-side power components and Power Modules	
<ul style="list-style-type: none"> Low overload (LO) 	Frame sizes FSA to FSC: -10 ... +40 °C (14 ... 104 °F) without derating Frame sizes FSD to FSF (PM230): 0 ... 40 °C (32 ... 104 °F) without derating Frame sizes FSD to FSF (PM240P-2): -20 ... +40 °C (-4 ... +104 °F) without derating Frame sizes FSA to FSF: >40 ... 60 °C (>104 ... 140 °F) see derating characteristics Frame sizes GX to JX: 0 ... 45 °C (32 ... 113 °F) without derating >45 ... 55 °C (>113 ... 131 °F) see derating characteristics SINAMICS G120P Cabinet: 0 ... 40 °C (32 ... 104 °F) without derating >40 ... 50 °C (>104 ... 122 °F) see derating characteristics
<ul style="list-style-type: none"> High overload (HO) 	Frame sizes FSA to FSC: -10 ... +50 °C (14 ... 122 °F) without derating Frame sizes FSD to FSF (PM230): 0 ... 50 °C (32 ... 122 °F) without derating Frame sizes FSD to FSF (PM240P-2): -20 ... +50 °C (-4 ... +122 °F) without derating >50 ... 60 °C (>122 ... 140 °F) see derating characteristics Frame sizes GX to JX: 0 ... 45 °C (32 ... 113 °F) without derating >45 ... 55 °C (>113 ... 131 °F) see derating characteristics SINAMICS G120P Cabinet: 0 ... 40 °C (32 ... 104 °F) without derating >40 ... 50 °C (>104 ... 122 °F) see derating characteristics
Installation altitude	Up to 1000 m (3281 ft) above sea level without derating, > 1000 m (3281 ft) see derating characteristics
Permissible ambient and coolant temperature (air) during operation for Control Units and supplementary system components	With CU230P-2 HVAC/DP with/without blanking cover: -10 ... +60 °C (14 ... 140 °F) With CU230P-2 PN with/without blanking cover: -10 ... +55 °C (14 ... 131 °F) With IOP-2/BOP-2: 0 ... 50 °C (32 ... 122 °F) Derating of 3 K/1000 m applies to Control Units as of an installation altitude of 1000 m (3281 ft) above sea level.
Climatic ambient conditions	
<ul style="list-style-type: none"> Storage ¹⁾ acc. to EN 60721-3-1 <ul style="list-style-type: none"> Drives and components, frame sizes FSA to FSF for PM230 Drives and components, frame sizes FSD to FSF for PM240P-2 Drives and components, frame sizes GX to JX and SINAMICS G120P Cabinet 	Temperature -40 ... +70 °C (-40 ... +158 °F) Relative air humidity <95 %, condensation not permissible Class 1K3 Temperature -25 ... +55 °C (-13 ... +131 °F) Relative air humidity 5 ... 95 %, condensation not permissible Class 1K4 Temperature -25 ... +55 °C (-13 ... +131 °F) Relative air humidity 5 ... 95 %, condensation not permissible
<ul style="list-style-type: none"> Transport ¹⁾ acc. to EN 60721-3-2 <ul style="list-style-type: none"> Drives and components, frame sizes FSA to FSF Drives and components, frame sizes GX to JX and SINAMICS G120P Cabinet 	Class 2K4 Temperature -40 ... +70 °C (-40 ... +158 °F) Max. air humidity 95 % at 40 °C (104 °F) Class 2K3 Temperature -25 ... +70 °C (-13 ... +158 °F), -40 °C (-40 °F) permissible for 24 h Relative air humidity 5 ... 95 % at 40 °C (104 °F)
<ul style="list-style-type: none"> Operation acc. to EN 60721-3-3 <ul style="list-style-type: none"> Drives and components, frame sizes FSA to FSF Drives and components, frame sizes GX to JX SINAMICS G120P Cabinet 	Class 3K3 Condensation, splashwater, and ice formation not permitted (EN 60204, Part 1) Class 3K3 Temperature 0 ... 45 °C (32 ... 113 °F), up to 55 °C (131 °F) with derating Relative air humidity 5 ... 95 % Condensation, splashwater and ice formation are not permitted (EN 60204, Part 1) Class 3K3 Temperature 0 ... 40 °C (32 ... 104 °F), up to 50 °C (122 °F) with derating Relative air humidity 5 ... 95 % Condensation, splashwater and ice formation are not permitted (EN 60204, Part 1)
Environmental class/harmful chemical substances	
<ul style="list-style-type: none"> Storage ¹⁾ acc. to EN 60721-3-1 Transport ¹⁾ acc. to EN 60721-3-2 Operation acc. to EN 60721-3-3 	Class 1C2 Class 2C2 Class 3C2
Organic/biological influences	
<ul style="list-style-type: none"> Storage ¹⁾ acc. to EN 60721-3-1 Transport ¹⁾ acc. to EN 60721-3-2 Operation acc. to EN 60721-3-3 	Class 1B1 Class 2B1 Class 3B1
Degree of pollution According to EN 61800-5-1	2

¹⁾ In transport packaging.

Technical specifications (continued)

Standards	
Compliance with standards	
• Drives and components, frame sizes FSA to FSF	UL, cUL ¹⁾ , CE, RCM, SEMI F47
• Drives, frame sizes GX to JX	cULus, CE, RCM, EAC, KC, SEMI F47 ²⁾
• SINAMICS G120P Cabinet	CE, RCM, EAC, KC, SEMI F47 ²⁾
CE marking	
According to Low Voltage Directive 2014/35/EU, EMC Directive 2014/30/EU	
EMC Directive	
According to EN 61800-3	
• PM230: Frame sizes FSA to FSF with integrated line filter class A, degree of protection IP20/UL Open Type and IP55/UL Type 12	The Power Modules comply with Category C2 according to EN 61800-3.
• PM230: Frame sizes FSA to FSF with integrated line filter class B, degree of protection IP55/UL Type 12	The Power Modules comply with the limit values for low-frequency line harmonics and conducted interference according to Category C1. They comply with the limit values for field-conducted interference emissions according to Category C2.
• PM240P-2: Frame sizes FSD to FSF (380 ... 480 V 3 AC) with integrated line filter class A	The Power Modules comply with Category C2 according to EN 61800-3.
• PM240P-2: Frame size FSF (500 ... 690 V 3 AC) with integrated line filter class A	The Power Modules comply with Category C3 according to EN 61800-3.
• PM330: Frame sizes GX to JX	Category C3 ³⁾
• PM330: Frame sizes GX to JX with additional line filter class A	Category C2 ⁴⁾
• SINAMICS G120P Cabinet	Category C3 ⁵⁾
• SINAMICS G120P Cabinet with additional line filter class A	Category C2 ⁵⁾

Note:

The EMC product standard EN 61800-3 does not apply directly to a frequency converter but to a PDS (Power Drive System), which comprises the complete circuitry, motor and cables in addition to the converter. The frequency converters on their own do not generally require identification according to the EMC Directive.

¹⁾ Applies to PM230 Power Modules frame sizes FSA to FSC and PM240P-2 Power Modules with integrated line filter class A.
²⁾ SEMI F47 for PM330 Power Modules, frame sizes HX (500 V to 690 V) and JX, available soon.

³⁾ Standard configuration: Devices installed in the control cabinet with EMC-compatible configuration, line reactor $u_K = 2\%$, shielded motor cable (e.g. Prototflex EMC) with max. 150 m cable length. Line harmonics acc. to EN 61000-2-4: Class 3, THD(U) total = 10 % for typical line conditions (RSC > 10); THD(I) total: typically 30 ... 45 % (15 > RSC > 50).
⁴⁾ Use in the second environment, for boundary conditions refer to ⁴⁾.

⁵⁾ For boundary conditions refer to ⁴⁾, cabinet is configured accordingly in version A.

System configuration

SINAMICS G120P and SINAMICS G120P Cabinet pump, fan, compressor converters

SINAMICS G120P and SINAMICS G120P Cabinet pump, fan, compressor converters

Technical specifications (continued)

Compliance with standards

CE marking



The SINAMICS G120P and SINAMICS G120P Cabinet converters meet the requirements of the Low-Voltage Directive 2014/35/EC.

Low-Voltage Directive

The converters comply with the following standards listed in the official journal of the EU:

- EN 60204
Safety of machinery, electrical equipment of machines
- EN 61800-5-1
Electrical power drive systems with variable speed – Part 5-1: Requirements regarding safety – electrical, thermal, and energy requirements

UL listing



Converters in UL category NMMS certified to UL and cUL, in compliance with UL508C or ULC61800-5-1. UL list numbers E121068 and E192450.

For use in environments with pollution degree 2.

On the Internet at www.ul.com

Machinery Directive

The converters are suitable for installation in machines. Compliance with the Machinery Directive 2006/42/EC requires a separate certificate of conformity. This must be provided by the plant construction company or the organization marketing the machine.

Functional safety

SINAMICS G120P and SINAMICS G120P Cabinet are not intended for use in installations with functional safety as defined by ISO 13849-1, IEC 61508-x.

EMC Directive

- EN 61800-3
Variable-speed electric drives
Part 3: EMC product standard including specific test methods

The following explanatory information applies to SINAMICS G120P and SINAMICS G120P Cabinet converters supplied by Siemens AG:

- The EMC product standard EN 61800-3 does not apply directly to a converter but to a PDS (Power Drive System), which comprises the complete circuitry, motor and cables in addition to the converter.

- Converters are normally only supplied to experts for installation in machines or systems. A converter must, therefore, only be considered as a component which, on its own, is not subject to the EMC product standard EN 61800-3. The converter's operating instructions, however, specifies the conditions regarding compliance with the product standard if the converter is expanded to become a PDS. For a PDS, the EMC Directive in the EU is complied with by observing the product standard EN 61800-3 for variable-speed electric drive systems. The converters on their own do not generally require identification according to the EMC Directive.
- Different categories C1 to C4 have been defined in accordance with the environment of the PDS at the operating location:
 - **Category C1:** Drive systems for rated voltages < 1000 V for use in the first environment
 - **Category C2:** Stationary drive systems not connected by means of a plug connector for rated voltages < 1000 V. When used in the first environment, the system must be installed and commissioned by personnel familiar with EMC requirements. A warning note is required.
 - **Category C3:** Drive systems for rated voltages < 1000 V for exclusive use in the second environment. A warning note is required.
 - **Category C4:** Drive systems for rated voltages ≥ 1000 V or for rated currents ≥ 400 A or for use in complex systems in the second environment. An EMC plan must be created.
- The EMC product standard EN 61800-3 also defines limit values for conducted interference and radiated interference for the "second environment" (= industrial power supply systems that do not supply households). These limit values are below the limit values of filter class A to EN 55011. Unfiltered converters can be used in industrial environments as long as they are part of a system that contains line filters on the higher-level infeed side.
- With SINAMICS G120P and SINAMICS G120P Cabinet, Power Drive Systems (PDS) that fulfill the EMC product standard EN 61800-3 can be configured when observing the installation instructions in the product documentation.
- A differentiation must be made between the product standards for electrical drive systems (PDS) of the range of standards EN 61800 (of which Part 3 covers EMC topics) and the product standards for the devices/systems/machines, etc. This will probably not result in any changes in the practical use of converters. Since converters are always part of a PDS and these are part of a machine, the machine manufacturer must observe various standards depending on their type and environment (e.g. EN 61000-3-2 for line harmonics and EN 55011 for radio interference). The product standard for PDS on its own is, therefore, either insufficient or irrelevant.
- With respect to the compliance with limits for line supply harmonics, the EMC product standard EN 61800-3 for PDS refers to compliance with the EN 61000-3-2 and EN 61000-3-12 standards. EN 61000-2-4 applies for devices >75 A.
- Regardless of the configuration with SINAMICS G120P and SINAMICS G120P Cabinet and its components, the machine construction company (OEM) can also apply other measures to ensure that the machine complies with the EU EMC Directive. The EU EMC Directive is generally fulfilled when the relevant EMC product standards are observed. If they are not available, the generic standards (e.g. EN 61000-x-x) can be used instead. It is important that the conducted and emitted interference at the line supply connection point and outside the machine remain below the relevant limit values. Any suitable technical measures can be applied to ensure this.

Technical specifications (continued)SEMI F47

SEMI F47 is an industry standard relating to the immunity to voltage dips. This includes the requirement that industrial equipment must be able to tolerate defined dips or drops of the line supply voltage. As a result, industrial equipment that fulfills this standard is more reliable and productive.

All Power Modules of the SINAMICS G120P product family fulfill the latest standard SEMI F47-0706¹⁾. In the case of a voltage dip, defined in accordance with SEMI F47-0706, these drives either continue to supply a defined output current, or using an automatic restart function, continue to operate as expected.

EAC approval for Russia/Belarus/Kazakhstan/Armenia

Since February 15, 2013, Russia, Kazakhstan, Belarus and Armenia have been united in the Eurasian EAC customs union. An EAC approval as replacement for the GOST mark is required for all products that are to be sold in Russia.

All devices delivered to the customs union must have these customs certifications.

RCM approval for Australia

The RCM mark is required for marketing Siemens components in Australia. Electronic devices must provide proof of EMC clearance in Australia, similar to the CE marking of conformity laid down by the EMC directive applicable in the EU. The converters must be marked accordingly. These requirements have been in force since October 1, 1999.

On March 1, 2016, the C-Tick mark was replaced by the RCM mark.

KC approval for South Korea

KC approval (formerly KCC) is required for the distribution of our electrical equipment in South Korea. Electronic devices that are covered by the EU Directive on Electromagnetic Compatibility must provide an EMC certificate issued by a resident authority in South Korea. The devices must be marked accordingly. This requirement has been in force since January 24, 2011.

Power ModulesGeneral technical specifications

Power Modules	PM230	PM240P-2	PM330	Cabinet
System operating voltage	380 ... 480 V $\pm 10\%$ 3 AC	380 ... 480 V 3 AC $\pm 10\%$ 500 ... 690 V 3 AC $\pm 10\%$	380 ... 480 V 3 AC $\pm 10\%$ 500 ... 690 V 3 AC $\pm 10\%$	380 ... 480 V 3 AC $\pm 10\%$ 500 ... 690 V 3 AC $\pm 10\%$
Grid requirement	>100	>25	>33 line reactor recommended	>33 ²⁾ Line reactors installed as standard
Short-circuit power R_{SC}				
Input frequency	47 ... 63 Hz	47 ... 63 Hz	47 ... 63 Hz	47 ... 63 Hz
Output frequency				
• Control mode V/f	0 ... 550 Hz	0 ... 550 Hz	0 ... 150 Hz	0 ... 150 Hz
• Control type Vector	0 ... 240 Hz	0 ... 200 Hz	0 ... 150 Hz	0 ... 150 Hz
Pulse frequency	4 kHz Higher pulse frequencies up to 16 kHz, see derating data	At 380 ... 480 V 3 AC: Up to 90 kW LO: 4 kHz From 110 kW LO: 2 kHz Higher pulse frequencies up to 16 kHz, see derating data At 500 ... 690 V 3 AC: 2 kHz, can be adjusted to 4 kHz	Self-adjusting up to 4 kHz	Self-adjusting up to 4 kHz
Power factor λ	0.9	0.9 ... 0.95	0.75 ... 0.93	0.75 ... 0.93
Offset factor $\cos \phi$	0.95	0.99	0.96	0.96
Efficiency	$\leq 97\%$	$> 97\%$	$> 98\%$	$> 98\%$
Output voltage, max. As % of input voltage	95 %	95 %	97 %	97 %

¹⁾ SEMI F47 for PM330 Power Modules frame size HX (500 V to 690 V) and JX available soon.

²⁾ Does not apply in conjunction with option **L01**.

System configuration

SINAMICS G120P and SINAMICS G120P Cabinet pump, fan, compressor converters

SINAMICS G120P and SINAMICS G120P Cabinet pump, fan, compressor converters

Technical specifications (continued)

Power Modules	PM230	PM240P-2	PM330	Cabinet
Overload capability <ul style="list-style-type: none"> Low overload (LO) <p><u>Note:</u> When the overload capability is used, the base-load current I_L is not reduced.</p> <ul style="list-style-type: none"> High overload (HO) <p><u>Note:</u> When the overload capability is used, the base-load current I_H is not reduced.</p>	<p>FSA to FSC: $1.5 \times$ base-load current I_L (i. e. 150 % overload) for 3 s plus $1.1 \times$ base-load current I_L (i. e. 110 % overload) for 57 s within a cycle time of 300 s</p> <p>FSD to FSF: $1.1 \times$ base-load current I_L (i. e. 110 % overload) for 60 s within a cycle time of 300 s</p> <p>FSA to FSC: $2 \times$ base-load current I_H (i. e. 200 % overload) for 3 s plus $1.5 \times$ base-load current I_H (i. e. 150 % overload) for 57 s within a cycle time of 300 s</p> <p>FSD to FSF: $1.5 \times$ base-load current I_H (i. e. 150 % overload) for 60 s within a cycle time of 300 s</p>	<p>$1.35 \times$ base-load current I_L (i. e. 135 % overload) for 3 s plus $1.1 \times$ base-load current I_L (i. e. 110 % overload) for 57 s within a cycle time of 300 s</p> <p>$1.5 \times$ base-load current I_H (i. e. 150 % overload) for 60 s within a cycle time of 300 s</p>	<p>$1.35 \times$ base-load current I_L (i. e. 135 % overload) for 3 s or $1.1 \times$ base-load current I_L (i. e. 110 % overload) for 60 s within a cycle time of 300 s</p> <p>$1.5 \times$ base-load current I_H (i. e. 150 % overload) for 60 s within a cycle time of 300 s</p>	<p>$1.35 \times$ base-load current I_L (i. e. 135 % overload) for 3 s or $1.1 \times$ base-load current I_L (i. e. 110 % overload) for 60 s within a cycle time of 300 s</p> <p>$1.5 \times$ base-load current I_H (i. e. 150 % overload) for 60 s within a cycle time of 300 s</p>
Possible braking methods	DC braking	DC braking Compound braking	DC braking Dynamic braking with optional Braking Module	DC braking Dynamic braking with optional Braking Module
Overvoltage category acc. to IEC 61800-5-1	III	III	Supply circuits: III Non-supply circuits: II	III
Degree of protection	IP55/UL Type 12 (with IOP-2, BOP-2 or blanking cover) IP20 (Standard or Push Through)	IP20	IP20	Standard: IP20 Optional: IP21, IP23, IP43 and IP54
Cooling	Power units with increased air cooling using integrated fans	Internal ventilation, power units with increased air cooling by built-in fans	Internal ventilation, power units with increased air cooling by built-in fans	Internal ventilation, power units with increased air cooling by built-in fans
Protection functions	<ul style="list-style-type: none"> Undervoltage Overvoltage Overcurrent/overload Overtemperature Ground fault Short-circuit Stall protection Motor blocking protection Motor overtemperature Parameter locking 			
Short-Circuit Current Rating SCCR acc. to UL (Short-Circuit Current Rating) ¹⁾	Degree of protection IP55 frame sizes FSA to FSC: 40 kA Degree of protection IP55 frame sizes FSD to FSF and degree of protection IP20: 65 kA	100 kA	100 kA ²⁾	–
Rated short-circuit current ICC acc. to IEC ²⁾	–	100 kA	100 kA ²⁾	65 kA ²⁾

¹⁾ Applies to industrial control panel installations according to NEC Article 409 or UL 508A/508C respectively UL 61800-5-1.

²⁾ In combination with the fuses specified in section Recommended line-side overcurrent protection devices.

Accessories**Optional accessories**Shield connection kit 1 for CU230P-2 HVAC/DP Control Units

Shield connection kit 1 offers optimum shield connection and strain relief for all signal and communication cables. It includes a matching shield bonding plate and all of the necessary connecting and retaining elements for mounting.

Shield connection kit 3 for CU230P-2 PN, CU240E-2 PN and CU240E-2 PN-F Control Units

Shield connection kit 3 offers optimum shield connection and strain relief for all signal and communication cables. It includes a matching shield bonding plate and all of the necessary connecting and retaining elements for mounting.

SINAMICS memory card (SD card)

The parameter settings for an inverter can be stored on the SINAMICS SD memory card. The SINAMICS SD card can be used to pre-parameterize inverters and to clone complete inverter data sets. When service is required, e.g. after the inverter has been replaced and the data have been downloaded from the memory card the drive system is immediately ready for use again. The associated slot is located on the top of the Control Unit.

PC inverter connection kit 2

For controlling and commissioning the inverter directly from a PC, if the STARTER commissioning tool has been installed on the PC.

Installation kit for line-side cable connection, left, for PM330 Power Modules

This installation kit allows supply cables to be brought in from the left-hand side of frame size GX and HX PM330 Power Modules. It is then possible to install the Power Module in the cabinet without any clearance at the top.

Spare partsMounting set for PM230 and PM240P-2 Power Modules

Depending on the frame size, different mounting sets are available for PM230 and PM240P-2 Power Modules.

Fan units for PM230 Power Modules

The PM230 Power Module is equipped with an internal and an external fan unit. Both of these can be replaced if necessary.

Replacement fans

The fans for PM240P-2 and PM330 Power Modules are available to order as replacement fans.

System configuration

SINAMICS G120P and SINAMICS G120P Cabinet pump, fan, compressor converters

Integrated Drive Systems

Overview

The core elements of a fully integrated drive system are frequency converters/inverters, motors, couplings and gear units. Siemens offers all the required components in top manufacturing quality from a single source, perfectly integrated – operating perfectly together, for all performance classes.

As a standard solution or tailored to individual requirements: no other provider on the market is able to offer a comparable portfolio. All Siemens drive components are optimally tuned to each other so that they interact ideally in every application.

Siemens Integrated Drive Systems turn simple drive components into real systems. Drive technology based on IDS ensures maximum productivity, energy efficiency and reliability in every automation environment and over the entire product lifecycle.

SINAMICS G120P frequency converters

SINAMICS G120P is an important element of an integrated drive system. The core elements of a fully integrated drive system are SINAMICS G120P frequency converters, motor types SIMOTICS SD and GP (VSD10 Line) and SIMOTICS FD, as well as couplings. Vertical integration is achieved by the CU230P-2 Control Unit.

Drives with a quadratic load torque ($M \sim n^2$), such as drives for pumps and fans, require the full torque at rated speed. Generally, increased starting torques or load surges do not occur.

The following applies to selection of a suitable converter for drives with a quadratic load torque: The rated current of the converter must be at least as large as the motor current at full torque in the required load point.

SIMOTICS GP and SIMOTICS SD – VSD10 Line motors

VSD10 Line motors are based on the 1LE1 platform and are available in the following versions:

- General Purpose Motors, shaft heights from 100 to 160, aluminum
- Severe Duty Motors, shaft heights from 100 to 315, cast iron

These motors are optimized for operation on a SINAMICS G120 converter. They are intended solely for converter operation. They must not be connected directly to a mains supply.

Functions integrated as standard for converter operation:

- Insulation system optimized for converter operation
- Built-in temperature sensor
- Bearing insulation NDE (shaft height 280/315)

The VSD10 Line provides the link to the SIMOTICS FD series for converter-fed motors.

SIMOTICS FD motors

The new generation of SIMOTICS FD (Flexible Duty) low-voltage motors will be available in four shaft heights with output ratings ranging from 200 kW to 1600 kW and higher. SIMOTICS FD motors are based on an innovative modular system. These air-cooled and water-cooled converter motors are available in numerous different versions and therefore suitable for a wide variety of applications in a host of different industries.

SIMOTICS FD in shaft heights 315 to 400 is designed for operation on SINAMICS G120P converters with output ratings ranging from 200 kW to 630 kW.

FLENDER couplings as part of the drive system

A drive system comprises individual machines, including the motor and gear unit. Couplings combine these components and frequently also establish the connection to the driven machine.

The coupling can perform other tasks in addition to the transmission of rotary motion and torque, such as:

- Compensation for **shaft misalignment** with low restorative forces
- Influencing of intrinsic torsional frequency and **damping**
- Torque interruption or limitation in response to **overload**
- Electrical **insulation**, noise insulation
- Function in **explosive environments**

Overview of relevant coupling types

Design	Description
N-EUPEX	Flexible cam coupling <ul style="list-style-type: none"> • Universally implementable coupling for compensation of shaft misalignment • Suitable for plug-in installation and easy assembly with three-part design Rated torque: 19 ... 62000 Nm
RUPEX	Flexible pin and bush coupling <ul style="list-style-type: none"> • Fail-safe, universal coupling for medium to very high torques with a good misalignment range • Compact design, low weights and mass moments of inertia • Suitable for plug-in assembly Rated torque: 200 ... 1300000 Nm
ARPEX	All-steel couplings <ul style="list-style-type: none"> • Zero-backlash, torsionally rigid coupling • For compensating radial, angular, and axial shaft misalignment by means of two flexible lamella packages made of stainless spring steel • Easy assembly thanks to compact lamella packages Rated torque: 92 ... 1450000 Nm

Overview (continued)

Overview tables

The tables on the following pages provide an overview of all converters with associated line-side and load-side components, DC link components and the available Control Units with operator panels.

SINAMICS G120P Power Modules for use in building technology for heating, air-conditioning and ventilation applications, with degree of protection IP20, 380 to 480 V 3 AC

SINAMICS G120P										
Rated power ¹⁾		Rated output current I_{rated} ²⁾	Power based on the base-load current I_H ³⁾		Base-load current I_H ³⁾	Power Module				
400 V	460 V		400 V	460 V		Frame size	Type	Without integrated line filter	With integrated line filter class A (Category C2)	
kW	hp	A	kW	hp	A			Article No.	Article No.	
0.37	0.5	1.3	0.25	0.33	0.9	FSA	PM230	6SL3210-1NE11-3UG1	6SL3210-1NE11-3AG1	
0.55	0.5	1.7	0.37	0.33	1.3			6SL3210-1NE11-7UG1	6SL3210-1NE11-7AG1	
0.75	0.75	2.2	0.55	0.5	1.7			6SL3210-1NE12-2UG1	6SL3210-1NE12-2AG1	
1.1	1	3.1	0.75	0.75	2.2			6SL3210-1NE13-1UG1	6SL3210-1NE13-1AG1	
1.5	2	4.1	1.1	1	3.1			6SL3210-1NE14-1UG1	6SL3210-1NE14-1AG1	
2.2	3	5.9	1.5	1.5	4.1			6SL3210-1NE15-8UG1	6SL3210-1NE15-8AG1	
3	3	7.7	2.2	3	5.9			6SL3210-1NE17-7UG1	6SL3210-1NE17-7AG1	
4	5	10.2	3	3	7.7	FSB		6SL3210-1NE21-0UG1	6SL3210-1NE21-0AG1	
5.5	7.5	13.2	4	5	10.2			6SL3210-1NE21-3UG1	6SL3210-1NE21-3AG1	
7.5	10	18	5.5	5	13.2			6SL3210-1NE21-8UG1	6SL3210-1NE21-8AG1	
11	15	26	7.5	10	18	FSC		6SL3210-1NE22-6UG1	6SL3210-1NE22-6AG1	
15	15	32	11	15	26			6SL3210-1NE23-2UG1	6SL3210-1NE23-2AG1	
18.5	20	38	15	15	32			6SL3210-1NE23-8UG1	6SL3210-1NE23-8AG1	
22	25	45	18.5	20	38	FSD		6SL3210-1NE24-5UL0	6SL3210-1RN24-5AL0	
30	30	60	22	25	45			6SL3210-1NE26-0UL0	6SL3210-1NE26-0AL0	
37	40	75	30	30	60	FSE		6SL3210-1NE27-5UL0	6SL3210-1NE27-5AL0	
45	50	90	37	40	75			6SL3210-1NE28-8UL0	6SL3210-1NE28-8AL0	
55	60	110	45	50	90	FSF		6SL3210-1NE31-1UL0	6SL3210-1NE31-1AL0	
75	75	145	55	60	110			6SL3210-1NE31-5UL0	6SL3210-1NE31-5AL0	
Push Through										
3	3	7.7	2.2	3	5.9	FSA	PM230	6SL3211-1NE17-7UG1	6SL3211-1NE17-7AG1	
7.5	10	18	5.5	5	13.2	FSB		6SL3211-1NE21-8UG1	6SL3211-1NE21-8AG1	
18.5	20	38	15	15	32	FSC		6SL3211-1NE23-8UG1	6SL3211-1NE23-8AG1	

¹⁾ Rated power based on the rated output current I_{rated} . The rated output current I_{rated} is based on the duty cycle for low overload (LO).

²⁾ The rated output current I_{rated} is based on the duty cycle for low overload (LO). These current values are valid for 400 V and are specified on the rating plate of the Power Module.

³⁾ The base-load current I_H is based on the duty cycle for high overload (HO).

System configuration

SINAMICS G120P and SINAMICS G120P Cabinet pump, fan, compressor converters

Integrated Drive Systems

Overview (continued)

SINAMICS G120P Power Modules for use in building technology for heating, air-conditioning and ventilation applications, with degree of protection IP20, 380 to 480 V 3 AC

SINAMICS G120P		Power Module	Control Unit	Operator panel
Rated power	460 V	Type	CU230P-2	IOP-2 or BOP-2
kW	hp		Article No.	Article No.
0.37	0.5	6SL3210-1NE11-3 . G1	6SL3243-0BB30-1 ■ ■ ■ ■	6SL3255-0AA00-4 ■ ■ ■ ■
0.55	0.5	6SL3210-1NE11-7 . G1		
0.75	0.75	6SL3210-1NE12-2 . G1		
1.1	1	6SL3210-1NE13-1 . G1		
1.5	2	6SL3210-1NE14-1 . G1		
2.2	3	6SL3210-1NE15-8 . G1		
3	3	6SL3210-1NE17-7 . G1		
4	5	6SL3210-1NE21-0 . G1		
5.5	7.5	6SL3210-1NE21-3 . G1		
7.5	10	6SL3210-1NE21-8 . G1		
11	15	6SL3210-1NE22-6 . G1		
15	15	6SL3210-1NE23-2 . G1		
18.5	20	6SL3210-1NE23-8 . G1		
22	25	6SL3210-1NE24-5 . LO		
30	30	6SL3210-1NE26-0 . LO		
37	40	6SL3210-1NE27-5 . LO		
45	50	6SL3210-1NE28-8 . LO		
55	60	6SL3210-1NE31-1 . LO		
75	75	6SL3210-1NE31-5 . LO		
Push Through				
3	3	6SL3211-1NE17-7 . G1	6SL3243-0BB30-1 ■ ■ ■ ■	6SL3255-0AA00-4 ■ ■ ■ ■
7.5	10	6SL3211-1NE21-8 . G1		
18.5	20	6SL3211-1NE23-8 . G1		
SINAMICS G120P Control Unit		Fieldbus protocols		
CU230P-2 HVAC		USS, Modbus RTU, BACnet MS/TP, FLN P1	H A 3	
CU230P-2 DP		PROFIBUS DP	P A 3	
CU230P-2 PN		PROFINET, EtherNet/IP	F A 0	
Operator panel		Operator panel		
IOP-2		Intelligent Operator Panel		
		<ul style="list-style-type: none"> German, English, French, Italian, Spanish, Portuguese, Dutch, Swedish, Russian, Czech, Polish, Turkish, Finnish, Chinese (simplified) 		NEW J A 2
BOP-2		Basic Operator Panel		C A 1

Overview (continued)

SINAMICS G120P Power Modules for use in building technology for heating, air-conditioning and ventilation applications, with degree of protection IP20, 380 to 480 V 3 AC

SINAMICS G120P		Power Module	Line-side components	Recommended line-side overcurrent protection devices	
Rated power				IEC-compliant	Circuit breaker
400 V	460 V	Type	Line filter class B (Category C1)	Fuse	Article No.
	kW		hp	Article No.	
0.37	0.5	6SL3210-1NE11-3 . G1	6SL3203-0BE17-7BA0	3NE1813-0	3RV1021-1CA10
0.55	0.5	6SL3210-1NE11-7 . G1	6SL3203-0BE17-7BA0	3NE1813-0	3RV1021-1DA10
0.75	0.75	6SL3210-1NE12-2 . G1	6SL3203-0BE17-7BA0	3NE1813-0	3RV1021-1FA10
1.1	1	6SL3210-1NE13-1 . G1	6SL3203-0BE17-7BA0	3NE1813-0	3RV1021-1GA10
1.5	2	6SL3210-1NE14-1 . G1	6SL3203-0BE17-7BA0	3NE1813-0	3RV1021-1JA10
2.2	3	6SL3210-1NE15-8 . G1	6SL3203-0BE17-7BA0	3NE1813-0	3RV1021-1KA10
3	3	6SL3210-1NE17-7 . G1	6SL3203-0BE17-7BA0	3NE1813-0	3RV1021-4AA10
4	5	6SL3210-1NE21-0 . G1	6SL3203-0BE21-8BA0	3NE1813-0	3RV1021-4BA10
5.5	7.5	6SL3210-1NE21-3 . G1	6SL3203-0BE21-8BA0	3NE1814-0	3RV1021-4DA10
7.5	10	6SL3210-1NE21-8 . G1	6SL3203-0BE21-8BA0	3NE1815-0	3RV1031-4EA10
11	15	6SL3210-1NE22-6 . G1	6SL3203-0BE23-8BA0	3NE1803-0	3RV1031-4FA10
15	15	6SL3210-1NE23-2 . G1	6SL3203-0BE23-8BA0	3NE1817-0	3RV1031-4HA10
18.5	20	6SL3210-1NE23-8 . G1	6SL3203-0BE23-8BA0	3NE1817-0	3RV1042-4KA10
22	25	6SL3210-1NE24-5 . L0	6SL3203-0BE27-5BA0	3NE1818-0	3RV1042-4KA10
30	30	6SL3210-1NE26-0 . L0	6SL3203-0BE27-5BA0	3NE1820-0	3RV1042-4MA10
37	40	6SL3210-1NE27-5 . L0	6SL3203-0BE31-1BA0	3NE1021-0	3VL1712-1DD33
45	50	6SL3210-1NE28-8 . L0	6SL3203-0BE31-1BA0	3NE1022-0	3VL1716-1DD33
55	60	6SL3210-1NE31-1 . L0	6SL3203-0BE31-8BA0	3NE1224-0	3VL3720-1DC36
75	75	6SL3210-1NE31-5 . L0	6SL3203-0BE31-8BA0	3NE1225-0	3VL3725-1DC36
Push Through					
3	3	6SL3211-1NE17-7 . L1	6SL3203-0BE17-7BA0	–	–
7.5	10	6SL3211-1NE21-8 . L1	6SL3203-0BE21-8BA0	–	–
18.5	20	6SL3211-1NE23-8 . L1	6SL3203-0BE23-8BA0	–	–

System configuration

SINAMICS G120P and SINAMICS G120P Cabinet pump, fan, compressor converters

Integrated Drive Systems

Overview (continued)

SINAMICS G120P Power Modules for use in building technology for heating, air-conditioning and ventilation applications, with degree of protection IP20, 380 to 480 V 3 AC

SINAMICS G120P		Power Module	Load-side power components	
Rated power	460 V		Output reactor	Sine-wave filter
400 V	460 V	Type	Article No.	Article No.
kW	hp			
0.37	0.5	6SL3210-1NE11-3 . G1	6SL3202-0AE16-1CA0	–
0.55	0.5	6SL3210-1NE11-7 . G1	6SL3202-0AE16-1CA0	–
0.75	0.75	6SL3210-1NE12-2 . G1	6SL3202-0AE16-1CA0	–
1.1	1	6SL3210-1NE13-1 . G1	6SL3202-0AE16-1CA0	–
1.5	2	6SL3210-1NE14-1 . G1	6SL3202-0AE16-1CA0	–
2.2	3	6SL3210-1NE15-8 . G1	6SL3202-0AE16-1CA0	–
3	3	6SL3210-1NE17-7 . G1	6SL3202-0AE18-8CA0	–
4	5	6SL3210-1NE21-0 . G1	6SL3202-0AE21-8CA0	–
5.5	7.5	6SL3210-1NE21-3 . G1	6SL3202-0AE21-8CA0	–
7.5	10	6SL3210-1NE21-8 . G1	6SL3202-0AE21-8CA0	–
11	15	6SL3210-1NE22-6 . G1	6SL3202-0AE23-8CA0	–
15	15	6SL3210-1NE23-2 . G1	6SL3202-0AE23-8CA0	–
18.5	20	6SL3210-1NE23-8 . G1	6SL3202-0AE23-8CA0	–
22	25	6SL3210-1NE24-5 . L0	6SE6400-3TC03-8DD0	6SL3202-0AE24-6SA0
30	30	6SL3210-1NE26-0 . L0	6SE6400-3TC05-4DD0	6SL3202-0AE26-2SA0
37	40	6SL3210-1NE27-5 . L0	6SE6400-3TC08-0ED0	6SL3202-0AE28-8SA0
45	50	6SL3210-1NE28-8 . L0	6SE6400-3TC07-5ED0	6SL3202-0AE28-8SA0
55	60	6SL3210-1NE31-1 . L0	6SE6400-3TC14-5FD0	6SL3202-0AE31-5SA0
75	75	6SL3210-1NE31-5 . L0	6SE6400-3TC15-4FD0	6SL3202-0AE31-5SA0
Push Through				
3	3	6SL3211-1NE17-7 . G1	6SL3202-0AE18-8CA0	–
7.5	10	6SL3211-1NE21-8 . G1	6SL3202-0AE21-8CA0	–
18.5	20	6SL3211-1NE23-8 . G1	6SL3202-0AE23-8CA0	–

Overview (continued)

SINAMICS G120P Power Modules for use in building technology for heating, air-conditioning and ventilation applications, with degree of protection IP55, 380 to 480 V 3 AC

SINAMICS G120P						Power Module			
Rated power ¹⁾		Rated output current I_{rated} ²⁾	Power based on the base-load current I_H ³⁾		Base-load current I_H ³⁾	Frame size	Type	With integrated line filter class A (Category C2)	With integrated line filter class B (Category C1)
400 V	460 V		400 V	460 V					
kW	hp	A	kW	hp	A			Article No.	Article No.
0.37	0.5	1.3	0.25	0.33	0.9	FSA	PM230	6SL3223-0DE13-7AG1	6SL3223-0DE13-7BG1
0.55	0.5	1.7	0.37	0.33	1.3			6SL3223-0DE15-5AG1	6SL3223-0DE15-5BG1
0.75	0.75	2.2	0.55	0.5	1.7			6SL3223-0DE17-5AG1	6SL3223-0DE17-5BG1
1.1	1	3.1	0.75	0.75	2.2			6SL3223-0DE21-1AG1	6SL3223-0DE21-1BG1
1.5	2	4.1	1.1	1	3.1			6SL3223-0DE21-5AG1	6SL3223-0DE21-5BG1
2.2	3	5.9	1.5	1.5	4.1			6SL3223-0DE22-2AG1	6SL3223-0DE22-2BG1
3	3	7.7	2.2	3	5.9			6SL3223-0DE23-0AG1	6SL3223-0DE23-0BG1
4	5	10.2	3	3	7.7	FSB		6SL3223-0DE24-0AG1	6SL3223-0DE24-0BG1
5.5	7.5	13.2	4	5	10.2			6SL3223-0DE25-5AG1	6SL3223-0DE25-5BG1
7.5	10	18	5.5	5	13.2			6SL3223-0DE27-5AG1	6SL3223-0DE27-5BG1
11	15	26	7.5	10	18	FSC		6SL3223-0DE31-1AG1	6SL3223-0DE31-1BG1
15	15	32	11	15	26			6SL3223-0DE31-5AG1	6SL3223-0DE31-5BG1
18.5	20	38	15	15	32			6SL3223-0DE31-8AG1	–
						FSD		–	6SL3223-0DE31-8BA0
22	25	45	18.5	20	38			6SL3223-0DE32-2AA0	6SL3223-0DE32-2BA0
30	30	60	22	25	45			6SL3223-0DE33-0AA0	6SL3223-0DE33-0BA0
37	40	75	30	30	60	FSE		6SL3223-0DE33-7AA0	6SL3223-0DE33-7BA0
45	50	90	37	40	75			6SL3223-0DE34-5AA0	6SL3223-0DE34-5BA0
55	60	110	45	50	90	FSF		6SL3223-0DE35-5AA0	6SL3223-0DE35-5BA0
75	75	145	55	60	110			6SL3223-0DE37-5AA0	6SL3223-0DE37-5BA0
90	100	178	75	75	145			6SL3223-0DE38-8AA0	6SL3223-0DE38-8BA0

¹⁾ Rated power based on the rated output current I_{rated} . The rated output current I_{rated} is based on the duty cycle for low overload (LO).
²⁾ The rated output current I_{rated} is based on the duty cycle for low overload (LO). These current values are valid for 400 V and are specified on the rating plate of the Power Module.

³⁾ The base-load current I_H is based on the duty cycle for high overload (HO).

System configuration

SINAMICS G120P and SINAMICS G120P Cabinet pump, fan, compressor converters

Integrated Drive Systems

Overview (continued)

SINAMICS G120P Power Modules for use in building technology for heating, air-conditioning and ventilation applications, with degree of protection IP55, 380 to 480 V 3 AC

SINAMICS G120P		Power Module	Control Unit	Operator panel
Rated power			CU230P-2	IOP-2 or BOP-2
400 V	460 V	Type	Article No.	Article No.
kW	hp		6SL3243-0BB30-1 ■ ■ ■	6SL3255-0AA00-4 ■ ■ ■
0.37	0.5	6SL3223-0DE13-7 . G1		
0.55	0.5	6SL3223-0DE15-5 . G1		
0.75	0.75	6SL3223-0DE17-5 . G1		
1.1	1	6SL3223-0DE21-1 . G1		
1.5	2	6SL3223-0DE21-5 . G1		
2.2	3	6SL3223-0DE22-2 . G1		
3	3	6SL3223-0DE23-0 . G1		
4	5	6SL3223-0DE24-0 . G1		
5.5	7.5	6SL3223-0DE25-5 . G1		
7.5	10	6SL3223-0DE27-5 . G1		
11	15	6SL3223-0DE31-1 . G1		
15	15	6SL3223-0DE31-5 . G1		
18.5	20	6SL3223-0DE31-8 . G .		
22	25	6SL3223-0DE32-2 . A0		
30	30	6SL3223-0DE33-0 . A0		
37	40	6SL3223-0DE33-7 . A0		
45	50	6SL3223-0DE34-5 . A0		
55	60	6SL3223-0DE35-5 . A0		
75	75	6SL3223-0DE37-5 . A0		
90	100	6SL3223-0DE38-8 . A0		
SINAMICS G120P Control Unit		Fieldbus protocols		
CU230P-2 HVAC		USS, Modbus RTU, BACnet MS/TP, FLN P1	H A 3	
CU230P-2 DP		PROFIBUS DP	P A 3	
CU230P-2 PN		PROFINET, EtherNet/IP	F A 0	
Operator panel		Operator panel		
IOP-2		Intelligent Operator Panel		
		<ul style="list-style-type: none"> German, English, French, Italian, Spanish, Portuguese, Dutch, Swedish, Russian, Czech, Polish, Turkish, Finnish, Chinese (simplified) 	NEW J A 2	
BOP-2		Basic Operator Panel		C A 1

Overview (continued)

SINAMICS G120P Power Modules for use in building technology for heating, air-conditioning and ventilation applications, with degree of protection IP55, 380 to 480 V 3 AC

SINAMICS G120P		Power Module Type	Recommended line-side overcurrent protection devices IEC-compliant		Load-side power components	
Rated power	Fuse type 3NA3 Article No.		Circuit breaker Article No.	Output reactor Article No.	Sine-wave filter Article No.	
400 V kW						460 V hp
0.37	0.5	6SL3223-0DE13-7 . G1	3NA3803	3RV2011-1CA10	6SL3202-0AE16-1CA0	–
0.55	0.5	6SL3223-0DE15-5 . G1	3NA3803	3RV2011-1DA10	6SL3202-0AE16-1CA0	–
0.75	0.75	6SL3223-0DE17-5 . G1	3NA3803	3RV2011-1FA10	6SL3202-0AE16-1CA0	–
1.1	1	6SL3223-0DE21-1 . G1	3NA3803	3RV2011-1GA10	6SL3202-0AE16-1CA0	–
1.5	2	6SL3223-0DE21-5 . G1	3NA3803	3RV2011-1JA10	6SL3202-0AE16-1CA0	–
2.2	3	6SL3223-0DE22-2 . G1	3NA3803	3RV2011-1KA10	6SL3202-0AE16-1CA0	–
3	3	6SL3223-0DE23-0 . G1	3NA3803	3RV2021-4AA10	6SL3202-0AE18-8CA0	–
4	5	6SL3223-0DE24-0 . G1	3NA3805	3RV2021-4BA10	6SL3202-0AE21-8CA0	–
5.5	7.5	6SL3223-0DE25-5 . G1	3NA3807	3RV2021-4BA10	6SL3202-0AE21-8CA0	–
7.5	10	6SL3223-0DE27-5 . G1	3NA3810	3RV1031-4EA10	6SL3202-0AE21-8CA0	–
11	15	6SL3223-0DE31-1 . G1	3NA3814	3RV1031-4FA10	6SL3202-0AE23-8CA0	–
15	15	6SL3223-0DE31-5 . G1	3NA3820	3RV1031-4HA10	6SL3202-0AE23-8CA0	–
18.5	20	6SL3223-0DE31-8AG1	3NA3820	3RV1042-4KA10	6SL3202-0AE23-8CA0	–
18.5	20	6SL3223-0DE31-8BA0	3NA3820	–	6SE6400-3TC03-8DD0	–
22	25	6SL3223-0DE32-2 . A0	3NA3822	–	6SE6400-3TC03-8DD0	6SL3202-0AE24-6SA0
30	30	6SL3223-0DE33-0 . A0	3NA3824	–	6SE6400-3TC05-4DD0	6SL3202-0AE26-2SA0
37	40	6SL3223-0DE33-7 . A0	3NA3830	–	6SE6400-3TC08-0ED0	6SL3202-0AE28-8SA0
45	50	6SL3223-0DE34-5 . A0	3NA3832	–	6SE6400-3TC07-5ED0	6SL3202-0AE28-8SA0
55	60	6SL3223-0DE35-5 . A0	3NA3836	–	6SE6400-3TC14-5FD0	6SL3202-0AE31-5SA0
75	75	6SL3223-0DE37-5 . A0	3NA3140	–	6SE6400-3TC15-4FD0	6SL3202-0AE31-5SA0
90	100	6SL3223-0DE38-8 . A0	3NA3144	–	6SE6400-3TC14-5FD0	6SL3202-0AE31-8SA0

System configuration

SINAMICS G120P and SINAMICS G120P Cabinet pump, fan, compressor converters

Integrated Drive Systems

Overview (continued)

SINAMICS G120P Power Modules for use in water/wastewater applications and in industrial environments, with degree of protection IP20, 380 to 480 V 3 AC

SINAMICS G120P									
Rated power ¹⁾		Rated output current I_{rated} ²⁾	Power based on the base-load current I_H ³⁾		Base-load current I_H ³⁾	Power Module			
400 V	460 V		400 V	460 V		Frame size	Type	Without integrated line filter	With integrated line filter class A (Category C2)
kW	hp	A	kW	hp	A			Article No.	Article No.
22	25	45	18.5	20	38	FSD	PM240P-2	6SL3210-1RE24-5UL0	6SL3210-1RE24-5AL0
30	30	60	22	25	45			6SL3210-1RE26-0UL0	6SL3210-1RE26-0AL0
37	40	75	30	30	60			6SL3210-1RE27-5UL0	6SL3210-1RE27-5AL0
45	50	90	37	40	75	FSE		6SL3210-1RE28-8UL0	6SL3210-1RE28-8AL0
55	60	110	45	50	90			6SL3210-1RE31-1UL0	6SL3210-1RE31-1AL0
75	75	145	55	60	110	FSF		6SL3210-1RE31-5UL0	6SL3210-1RE31-5AL0
90	100	178	75	75	145			6SL3210-1RE31-8UL0	6SL3210-1RE31-8AL0
110	125	205	90	100	178			6SL3210-1RE32-1UL0	6SL3210-1RE32-1AL0
132	150	250	110	125	205			6SL3210-1RE32-5UL0	6SL3210-1RE32-5AL0
160	200	300	132	150	240	GX	PM330	6SL3310-1PE33-0AA0	–
200	250	370	160	200	296			6SL3310-1PE33-7AA0	–
250	300	460	200	200	368			6SL3310-1PE34-6AA0	–
315	400	585	250	300	468	HX		6SL3310-1PE35-8AA0	–
355	450	655	250	300	491			6SL3310-1PE36-6AA0	–
400	500	735	315	350	551			6SL3310-1PE37-4AA0	–
450	500	840	355	450	672	JX		6SL3310-1PE38-4AA0	–
500	600	910	400	500	728			6SL3310-1PE38-8AA0	–
560	700	1021	450	500	786			6SL3310-1PE41-0AA0	–

¹⁾ PM240P-2: Rated power based on the rated output current I_{rated} . The rated output current I_{rated} is based on the duty cycle for low overload (LO). PM330: Rated power based on the base-load current I_L . The base-load current I_L is based on the duty cycle for low overload (LO).

²⁾ PM240P-2: The rated output current I_{rated} is based on the duty cycle for low overload (LO). These current values are valid for 400 V and are specified on the rating plate of the Power Module.

³⁾ The base-load current I_H is based on the duty cycle for high overload (HO).

Overview (continued)

SINAMICS G120P Power Modules for use in water/wastewater applications and in industrial environments, with degree of protection IP20, 380 to 480 V 3 AC

SINAMICS G120P		Power Module	Control Unit	Operator panel
Rated power			CU230P-2	IOP-2 or BOP-2
400 V	460 V		Article No.	Article No.
kW	hp	Type	6SL3243-0BB30-1 ■ ■ ■ ■	6SL3255-0AA00-4 ■ ■ ■ ■
22	25	6SL3210-1RE24-5 . LO		
30	30	6SL3210-1RE26-0 . LO		
37	40	6SL3210-1RE27-5 . LO		
45	50	6SL3210-1RE28-8 . LO		
55	60	6SL3210-1RE31-1 . LO		
75	75	6SL3210-1RE31-5 . LO		
90	100	6SL3210-1RE31-8 . LO		
110	125	6SL3210-1RE32-1 . LO		
132	150	6SL3210-1RE32-5 . LO		
160	200	6SL3310-1PE33-0AA0		
200	250	6SL3310-1PE33-7AA0		
250	300	6SL3310-1PE34-6AA0		
315	400	6SL3310-1PE35-8AA0		
355	450	6SL3310-1PE36-6AA0		
400	500	6SL3310-1PE37-4AA0		
450	500	6SL3310-1PE38-4AA0		
500	600	6SL3310-1PE38-8AA0		
560	700	6SL3310-1PE41-0AA0		
SINAMICS G120P Control Unit		Fieldbus protocols		
CU230P-2 HVAC		USS, Modbus RTU, BACnet MS/TP, FLN P1	H A 3	
CU230P-2 DP		PROFIBUS DP	P A 3	
CU230P-2 PN		PROFINET, EtherNet/IP	F A 0	
Operator panel		Operator Panel		
IOP-2		Intelligent Operator Panel		
		<ul style="list-style-type: none"> German, English, French, Italian, Spanish, Portuguese, Dutch, Swedish, Russian, Czech, Polish, Turkish, Finnish, Chinese (simplified) 	NEW	J A 2
BOP-2		Basic Operator Panel		C A 1

System configuration

SINAMICS G120P and SINAMICS G120P Cabinet pump, fan, compressor converters

Integrated Drive Systems

Overview (continued)

SINAMICS G120P Power Modules for use in water/wastewater applications and in industrial environments, with degree of protection IP20, 380 to 480 V 3 AC

SINAMICS G120P		Power Module	Line-side components			
Rated power			Line filter class A (Category C2) Only in combination with Power Modules without integrated line filter	Line reactor	Main contactor	Switch disconnecter
400 V	460 V	Type	Article No.	Article No.	Type	Type
kW	hp					
22	25	6SL3210-1RE24-5 . LO	–	–	3RT2027-1AP00	3KL5230-1GB01
30	30	6SL3210-1RE26-0 . LO	–	–	3RT2036-1AP04	3KL5230-1GB01
37	40	6SL3210-1RE27-5 . LO	–	–	3RT2037-1AP00	3KL5230-1GB01
45	50	6SL3210-1RE28-8 . LO	–	–	3RT1044-1AP04	3KL5230-1GB01
55	60	6SL3210-1RE31-1 . LO	–	–	3RT1045-1AP04	3KL5530-1GB01
75	75	6SL3210-1RE31-5 . LO	–	–	3RT1054-6AP36	3KL5530-1GB01
90	100	6SL3210-1RE31-8 . LO	–	–	3RT1056-6AP36	3KL5530-1GB01
110	125	6SL3210-1RE32-1 . LO	–	–	3RT1064-6AP36	3KL5730-1GB01
132	150	6SL3210-1RE32-5 . LO	–	–	3RT1064-6AP36	3KL5730-1GB01
160	200	6SL3310-1PE33-0AA0	6SL3000-0BE33-1AA0	6SL3000-0CE33-3AA0	3RT1456 (2 units)	3KL5730
200	250	6SL3310-1PE33-7AA0	6SL3000-0BE33-1AA0	6SL3000-0CE35-1AA0	3RT1456 (2 units)	3KL5730
250	300	6SL3310-1PE34-6AA0	6SL3000-0BE35-0AA0	6SL3000-0CE35-1AA0	3RT1456 (3 units)	3KL6130
315	400	6SL3310-1PE35-8AA0	6SL3760-0MR00-0AA0	6SL3000-0CE36-3AA0	3RT1456 (3 units)	3KL6130
355	450	6SL3310-1PE36-6AA0	6SL3760-0MR00-0AA0	6SL3000-0CE37-7AA0	3RT1466 (2 units)	3KL6230
400	500	6SL3310-1PE37-4AA0	6SL3760-0MR00-0AA0	6SL3000-0CE37-7AA0	3RT1466 (3 units)	3KL6230
450	500	6SL3310-1PE38-4AA0	6SL3760-0MR00-0AA0	6SL3000-0CE38-7AA0	3RT1466 (3 units)	3KD5034
500	600	6SL3310-1PE38-8AA0	6SL3760-0MR00-0AA0	6SL3000-0CE41-0AA0	3RT1466 (3 units)	3KD5034
560	700	6SL3310-1PE41-0AA0	6SL3760-0MR00-0AA0	6SL3000-0CE41-0AA0	3RT1476 (2 units)	3KD5234

Overview (continued)

SINAMICS G120P Power Modules for use in water/wastewater applications and in industrial environments, with degree of protection IP20, 380 to 480 V 3 AC

SINAMICS G120P		Power Module	Recommended line-side overcurrent protection devices		DC link components
Rated power			IEC-compliant		
400 V	460 V	Type	Fuse	Circuit breaker	Braking Module / braking resistor
			Type 3NE1 (9A)	Article No.	
kW	hp		Article No.	Article No.	Article No.
22	25	6SL3210-1RE24-5 . L0	3NE1820-0	1)	—
30	30	6SL3210-1RE26-0 . L0	3NE1021-0	1)	—
37	40	6SL3210-1RE27-5 . L0	3NE1021-0	1)	—
45	50	6SL3210-1RE28-8 . L0	3NE1022-0	1)	—
55	60	6SL3210-1RE31-1 . L0	3NE1224-0	1)	—
75	75	6SL3210-1RE31-5 . L0	3NE1225-0	1)	—
90	100	6SL3210-1RE31-8 . L0	3NE1227-0	1)	—
110	125	6SL3210-1RE32-1 . L0	3NE1230-0	1)	—
132	150	6SL3210-1RE32-5 . L0	3NE1331-0	1)	—
160	200	6SL3310-1PE33-0AA0	3NE1333-2	—	6SL3760-1AE32-6AA0 6SE3760-5FS87-2DC0
200	250	6SL3310-1PE33-7AA0	3NE1334-2	—	6SL3760-1AE32-6AA0 6SE3760-5FS87-2DC0
250	300	6SL3310-1PE34-6AA0	3NE1435-2	—	6SL3760-1AE32-6AA0 6SE3760-5FS87-2DC0
315	400	6SL3310-1PE35-8AA0	3NE1437-2	—	6SL3760-1AE32-6AA0 6SE3760-5FS87-2DC0
355	450	6SL3310-1PE36-6AA0	3NE1438-2	—	6SL3760-1AE32-6AA0 6SE3760-5FS87-2DC0
400	500	6SL3310-1PE37-4AA0	3NE1448-2	—	6SL3760-1AE32-6AA0 6SE3760-5FS87-2DC0
450	500	6SL3310-1PE38-4AA0	3NE1334-3 (2 units)	—	6SL3760-1AE32-6AA0 6SE3760-5FS87-2DC0
500	600	6SL3310-1PE38-8AA0	3NE1435-3 (2 units)	—	6SL3760-1AE32-6AA0 6SE3760-5FS87-2DC0
560	700	6SL3310-1PE41-0AA0	3NE1436-3 (2 units)	—	6SL3760-1AE32-6AA0 6SE3760-5FS87-2DC0

SINAMICS G120P		Power Module	Load-side power components		
Rated power			Output reactor	dv/dt filter plus VPL	dv/dt filter compact plus VPL
400 V	460 V	Type	Article No.	Article No.	Article No.
			Article No.	Article No.	Article No.
kW	hp				
22	25	6SL3210-1RE24-5 . L0	6SE6400-3TC07-5ED0	—	—
30	30	6SL3210-1RE26-0 . L0	6SE6400-3TC07-5ED0	—	—
37	40	6SL3210-1RE27-5 . L0	6SE6400-3TC07-5ED0	—	—
45	50	6SL3210-1RE28-8 . L0	6SE6400-3TC14-5FD0	—	—
55	60	6SL3210-1RE31-1 . L0	6SE6400-3TC14-5FD0	—	—
75	75	6SL3210-1RE31-5 . L0	6SE6400-3TC14-5FD0	—	—
90	100	6SL3210-1RE31-8 . L0	6SE6400-3TC14-5FD0	—	—
110	125	6SL3210-1RE32-1 . L0	6SL3000-2BE32-1AA0	—	—
132	150	6SL3210-1RE32-5 . L0	6SL3000-2BE32-6AA0	—	—
160	200	6SL3310-1PE33-0AA0	6SL3000-2BE33-2AA0	6SL3000-2DE35-0AA0	6SL3000-2DE35-0EA0
200	250	6SL3310-1PE33-7AA0	6SL3000-2BE33-8AA0	6SL3000-2DE35-0AA0	6SL3000-2DE35-0EA0
250	300	6SL3310-1PE34-6AA0	6SL3000-2BE35-0AA0	6SL3000-2DE35-0AA0	6SL3000-2DE35-0EA0
315	400	6SL3310-1PE35-8AA0	6SL3000-2AE36-1AA0	6SL3000-2DE38-4AA0	6SL3000-2DE38-4EA0
355	450	6SL3310-1PE36-6AA0	6SL3000-2AE38-4AA0	6SL3000-2DE38-4AA0	6SL3000-2DE38-4EA0
400	500	6SL3310-1PE37-4AA0	6SL3000-2AE38-4AA0	6SL3000-2DE38-4AA0	6SL3000-2DE38-4EA0
450	500	6SL3310-1PE38-4AA0	6SL3000-2AE41-0AA0	6SL3000-2DE41-4AA0	6SL3000-2DE41-4EA0
500	600	6SL3310-1PE38-8AA0	6SL3000-2AE41-0AA0	6SL3000-2DE41-4AA0	6SL3000-2DE41-4EA0
560	700	6SL3310-1PE41-0AA0	6SL3000-2AE41-4AA0	6SL3000-2DE41-4AA0	6SL3000-2DE41-4EA0

1) Recommendations on further overcurrent protection devices are available at:
<https://support.industry.siemens.com/cs/document/109750825>

System configuration

SINAMICS G120P and SINAMICS G120P Cabinet pump, fan, compressor converters

Integrated Drive Systems

Overview (continued)

SINAMICS G120P Power Modules for use in water/wastewater applications and in industrial environments, with degree of protection IP20, 500 to 690 V 3 AC

SINAMICS G120P										
Rated power ¹⁾		Rated output current I_{rated} ²⁾	Power based on the base-load current I_H ³⁾		Base-load current I_H ³⁾	Power Module				
690 V	575 V		690 V	575 V		Frame size	Type	Without integrated line filter	With integrated line filter class A (Category C2 ⁴⁾)	
kW	hp	A	kW	hp	A			Article No.	Article No.	
11	10	14	7.5	8	11	FSD	PM240P-2	6SL3210-1RH21-4UL0	6SL3210-1RH21-4AL0	
15	15	19	11	10	14			6SL3210-1RH22-0UL0	6SL3210-1RH22-0AL0	
18.5	20	23	15	15	19			6SL3210-1RH22-3UL0	6SL3210-1RH22-3AL0	
22	25	27	18.5	20	23			6SL3210-1RH22-7UL0	6SL3210-1RH22-7AL0	
30	30	35	22	25	27			6SL3210-1RH23-5UL0	6SL3210-1RH23-5AL0	
37	40	42	30	30	35			6SL3210-1RH24-2UL0	6SL3210-1RH24-2AL0	
45	50	52	37	40	42	FSE		6SL3210-1RH25-2UL0	6SL3210-1RH25-2AL0	
55	60	62	45	50	52			6SL3210-1RH26-2UL0	6SL3210-1RH26-2AL0	
75	75	80	55	60	62	FSF		6SL3210-1RH28-0UL0	6SL3210-1RH28-0AL0	
90	100	100	75	75	80			6SL3210-1RH31-0UL0	6SL3210-1RH31-0AL0	
110	100	115	90	100	100			6SL3210-1RH31-2UL0	6SL3210-1RH31-2AL0	
132	125	142	110	100	115			6SL3210-1RH31-4UL0	6SL3210-1RH31-4AL0	
315	350	340	250	250	272	HX	PM330	6SL3310-1PG33-7AA0	–	
355	400	393	315	300	314			6SL3310-1PG34-0AA0	–	
400	450	430	355	350	348			6SL3310-1PG34-5AA0	–	
450	450	480	400	450	394			6SL3310-1PG35-2AA0	–	
500	500	535	450	450	444	JX		6SL3310-1PG35-8AA0	–	
560	600	595	500	500	476			6SL3310-1PG36-5AA0	–	
630	700	665	560	500	532			6SL3310-1PG37-2AA0	–	

¹⁾ PM240P-2: Rated power based on the rated output current I_{rated} . The rated output current I_{rated} is based on the duty cycle for low overload (LO). PM330: Rated power based on the base-load current I_L . The base-load current I_L is based on the duty cycle for low overload (LO).

²⁾ PM240P-2: The rated output current I_{rated} is based on the duty cycle for low overload (LO). These current values are valid for 690 V and are specified on the rating plate of the Power Module.

³⁾ The base-load current I_H is based on the duty cycle for high overload (HO)

⁴⁾ PM240P-2: The Power Modules in frame size FSF with integrated line filter comply with radio interference category C3 according to EN 61800-3.

Overview (continued)

SINAMICS G120P Power Modules for use in water/wastewater applications and in industrial environments, with degree of protection IP20, 500 to 690 V 3 AC

SINAMICS G120P		Power Module	Control Unit	Operator panel
Rated power			CU230P-2	IOP-2 or BOP-2
690 V	575 V	Type	Article No.	Article No.
kW	hp		6SL3243-0BB30-1 ■ ■ ■	6SL3255-0AA00-4 ■ ■ ■
11	10	6SL3210-1RH21-4 . LO		
15	15	6SL3210-1RH22-0 . LO		
18.5	20	6SL3210-1RH22-3 . LO		
22	25	6SL3210-1RH22-7 . LO		
30	30	6SL3210-1RH23-5 . LO		
37	40	6SL3210-1RH24-2 . LO		
45	50	6SL3210-1RH25-2 . LO		
55	60	6SL3210-1RH26-2 . LO		
75	75	6SL3210-1RH28-0 . LO		
90	100	6SL3210-1RH31-0 . LO		
110	100	6SL3210-1RH31-2 . LO		
132	125	6SL3210-1RH31-4 . LO		
315	350	6SL3310-1PG33-7AA0		
355	400	6SL3310-1PG34-0AA0		
400	450	6SL3310-1PG34-5AA0		
450	450	6SL3310-1PG35-2AA0		
500	500	6SL3310-1PG35-8AA0		
560	600	6SL3310-1PG36-5AA0		
630	700	6SL3310-1PG37-2AA0		
SINAMICS G120P Control Unit		Fieldbus protocols		
CU230P-2 HVAC		USS, Modbus RTU, BACnet MS/TP, FLN P1	H A 3	
CU230P-2 DP		PROFIBUS DP	P A 3	
CU230P-2 PN		PROFINET, EtherNet/IP	F A 0	
Operator panel		Operator Panel		
IOP-2		Intelligent Operator Panel		
		<ul style="list-style-type: none"> German, English, French, Italian, Spanish, Portuguese, Dutch, Swedish, Russian, Czech, Polish, Turkish, Finnish, Chinese (simplified) 	NEW	J A 2
BOP-2		Basic Operator Panel		C A 1

System configuration

SINAMICS G120P and SINAMICS G120P Cabinet pump, fan, compressor converters

Integrated Drive Systems

Overview (continued)

SINAMICS G120P Power Modules for use in water/wastewater applications and in industrial environments, with degree of protection IP20, 500 to 690 V 3 AC

SINAMICS G120P		Power Module	Line-side components			
Rated power			Line filter class A (Category C2) Only in combination with Power Modules without integrated line filter	Line reactor	Main contactor	Switch disconnecter
690 V	575 V	Type	Article No.	Article No.	Type	Type
kW	hp					
11	10	6SL3210-1RH21-4 . LO	—	—	3RT2015-1AP01	3KL5030-1GB01
15	15	6SL3210-1RH22-0 . LO	—	—	3RT2016-1AP01	3KL5030-1GB01
18.5	20	6SL3210-1RH22-3 . LO	—	—	3RT2023-1AP04	3KL5030-1GB01
22	25	6SL3210-1RH22-7 . LO	—	—	3RT2023-1AP04	3KL5030-1GB01
30	30	6SL3210-1RH23-5 . LO	—	—	3RT2023-1AP04	3KL5030-1GB01
37	40	6SL3210-1RH24-2 . LO	—	—	3RT2027-1AP00	3KL5030-1GB01
45	50	6SL3210-1RH25-2 . LO	—	—	3RT2035-1AP04	3KL5230-1GB01
55	60	6SL3210-1RH26-2 . LO	—	—	3RT2036-1AP04	3KL5230-1GB01
75	75	6SL3210-1RH28-0 . LO	—	—	3RT2038-1AP04	3KL5230-1GB01
90	100	6SL3210-1RH31-0 . LO	—	—	3RT1045-1AP04	3KL5230-1GB01
110	100	6SL3210-1RH32-2 . LO	—	—	3RT1054-6AP36	3KL5530-1GB01
132	125	6SL3210-1RH31-4 . LO	—	—	3RT1056-6AP36	3KL5530-1GB01
315	350	6SL3310-1PG33-7AA0	6SL3760-0MS00-0AA0	6SL3000-0CH34-8AA0	3RT1476	3KL5730-1AB01
355	400	6SL3310-1PG34-0AA0	6SL3760-0MS00-0AA0	6SL3000-0CH34-8AA0	3RT1476	3KL6130-1AB02
400	450	6SL3310-1PG34-5AA0	6SL3760-0MS00-0AA0	6SL3000-0CH34-8AA0	3RT1476	3KL6130-1AB02
450	450	6SL3310-1PG35-2AA0	6SL3760-0MS00-0AA0	6SL3000-0CH36-0AA0	3RT1476	3KL6130-1AB02
500	500	6SL3310-1PG35-8AA0	6SL3760-0MS00-0AA0	6SL3000-0CH36-0AA0	3RT1466-6AP36 (3 units)	3KD4634
560	600	6SL3310-1PG36-5AA0	6SL3760-0MS00-0AA0	6SL3000-0CH38-4AA0	3RT1466-6AP36 (3 units)	3KD4834
630	700	6SL3310-1PG37-2AA0	6SL3760-0MS00-0AA0	6SL3000-0CH38-4AA0	3RT1466-6AP36 (3 units)	3KD5034

SINAMICS G120P		Power Module	Recommended line-side overcurrent protection devices	
Rated power			Fuse	Circuit breaker
690 V	575 V	Type	Article No.	Article No.
kW	hp		Type 3NE1 (⚡)	
11	10	6SL3210-1RH21-4 . LO	3NE1815-0	1)
15	15	6SL3210-1RH22-0 . LO	3NE1815-0	1)
18.5	20	6SL3210-1RH22-3 . LO	3NE1803-0	1)
22	25	6SL3210-1RH22-7 . LO	3NE1803-0	1)
30	30	6SL3210-1RH23-5 . LO	3NE1817-0	1)
37	40	6SL3210-1RH24-2 . LO	3NE1818-0	1)
45	50	6SL3210-1RH25-2 . LO	3NE1820-0	1)
55	60	6SL3210-1RH26-2 . LO	3NE1820-0	1)
75	75	6SL3210-1RH28-0 . LO	3NE1021-0	1)
90	100	6SL3210-1RH31-0 . LO	3NE1022-0	1)
110	100	6SL3210-1RH32-2 . LO	3NE1224-0	1)
132	125	6SL3210-1RH31-4 . LO	3NE1225-0	1)
315	350	6SL3310-1PG33-7AA0	3NE1333-2	—
355	400	6SL3310-1PG34-0AA0	3NE1334-2	—
400	450	6SL3310-1PG34-5AA0	3NE1435-2	—
450	450	6SL3310-1PG35-2AA0	3NE1436-2	—
500	500	6SL3310-1PG35-8AA0	3NE1437-2	—
560	600	6SL3310-1PG36-5AA0	3NE1438-2	—
630	700	6SL3310-1PG37-2AA0	3NE1448-2	—

1) Recommendations on further overcurrent protection devices including circuit breakers are available at:

<https://support.industry.siemens.com/cs/document/109750825>

Overview (continued)

SINAMICS G120P Power Modules for use in water/wastewater applications and in industrial environments, with degree of protection IP20, 500 to 690 V 3 AC

SINAMICS G120P		Power Module	Load-side power components		
Rated power 690 V	575 V		Output reactor	dv/dt filter plus VPL	dv/dt filter compact plus VPL
kW	hp	Type	Article No.	Article No.	Article No.
11	10	6SL3210-1RH21-4 . L0	–	6SL3000-2DH31-0AA0	–
15	15	6SL3210-1RH22-0 . L0	–	6SL3000-2DH31-0AA0	–
18,5	20	6SL3210-1RH22-3 . L0	–	6SL3000-2DH31-0AA0	–
22	25	6SL3210-1RH22-7 . L0	–	6SL3000-2DH31-0AA0	–
30	30	6SL3210-1RH23-5 . L0	–	6SL3000-2DH31-0AA0	–
37	40	6SL3210-1RH24-2 . L0	–	6SL3000-2DH31-0AA0	–
45	50	6SL3210-1RH25-2 . L0	–	6SL3000-2DH31-0AA0	–
55	60	6SL3210-1RH26-2 . L0	–	6SL3000-2DH31-0AA0	–
75	75	6SL3210-1RH28-0 . L0	6SL3000-2AH31-0AA0	6SL3000-2DH31-0AA0	–
90	100	6SL3210-1RH31-0 . L0	6SL3000-2AH31-0AA0	6SL3000-2DH31-0AA0	–
110	100	6SL3210-1RH32-2 . L0	6SL3000-2AH31-5AA0	6SL3000-2DH31-5AA0	–
132	125	6SL3210-1RH31-4 . L0	6SL3000-2AH31-5AA0	6SL3000-2DH31-5AA0	–
315	350	6SL3310-1PG33-7AA0	6SL3000-2AH34-7AA0	6SL3000-2DH35-8AA0	6SL3000-2DG35-8EA0
355	400	6SL3310-1PG34-0AA0	6SL3000-2AH34-7AA0	6SL3000-2DH35-8AA0	6SL3000-2DG35-8EA0
400	450	6SL3310-1PG34-5AA0	6SL3000-2AH35-8AA0	6SL3000-2DH35-8AA0	6SL3000-2DG35-8EA0
450	450	6SL3310-1PG35-2AA0	6SL3000-2AH38-1AA0	6SL3000-2DH38-1AA0	6SL3000-2DG38-1EA0
500	500	6SL3310-1PG35-8AA0	6SL3000-2AH38-1AA0	6SL3000-2DH38-1AA0	6SL3000-2DG38-1EA0
560	600	6SL3310-1PG36-5AA0	6SL3000-2AH38-1AA0	6SL3000-2DH38-1AA0	6SL3000-2DG38-1EA0
630	700	6SL3310-1PG37-2AA0	6SL3000-2AH38-1AA0	6SL3000-2DH38-1AA0	6SL3000-2DG38-1EA0

System configuration

SINAMICS G120P and SINAMICS G120P Cabinet pump, fan, compressor converters

Integrated Drive Systems

Overview (continued)

SINAMICS G120P Cabinet for use in water/wastewater applications and in industrial environments, with degree of protection IP20, 380 to 480 V 3 AC

SINAMICS G120P Cabinet						SINAMICS G120P Cabinet		Control Unit	Operator panel		
Rated power ¹⁾		Rated output current I_{rated}	Power based on the base-load current I_H ²⁾		Base-load current I_H ²⁾	Frame size	Power Module	Version A All available line connection components can be installed as required	Version C Especially space-saving design	CU230P-2 (It is essential to specify one of the order codes below)	Intelligent Operator Panel IOP-2
400 V	460 V	A	kW	hp	A	Type	Article No.	Article No.			
75	75	145	55	60	110	F	PM240P-2	6SL3710-1PE31-5AB0-Z	–	■ ■ ■	Mounted in door as standard
90	100	178	75	75	145			6SL3710-1PE31-8AB0-Z	–		
110	125	205	90	100	178			6SL3710-1PE32-1AB0-Z	–		
132	150	250	110	125	205			6SL3710-1PE32-5AB0-Z	–		
160	200	300	132	150	240	GX	PM330	6SL3710-1PE33-0AA0-Z	6SL3710-1PE33-0CA0-Z		
200	250	370	160	200	296			6SL3710-1PE33-7AA0-Z	6SL3710-1PE33-7CA0-Z		
250	300	460	200	200	368			6SL3710-1PE34-6AA0-Z	6SL3710-1PE34-6CA0-Z		
315	400	585	250	300	468	HX		6SL3710-1PE35-8AA0-Z	6SL3710-1PE35-8CA0-Z		
355	450	655	250	300	491			6SL3710-1PE36-6AA0-Z	6SL3710-1PE36-6CA0-Z		
400	500	735	315	350	551			6SL3710-1PE37-4AA0-Z	6SL3710-1PE37-4CA0-Z		
450	500	840	355	450	672	JX		6SL3710-1PE38-4AA0-Z	–		
500	600	910	400	500	728			6SL3710-1PE38-8AA0-Z	–		
560	700	1021	450	500	786			6SL3710-1PE41-0AA0-Z	–		
SINAMICS G120P Control Unit								Fieldbus protocols			
CU230P-2 HVAC								USS, Modbus RTU, BACnet MS/TP, FLN P1	K 9 8		
CU230P-2 DP								PROFIBUS DP	K 9 7		
CU230P-2 PN								PROFINET, EtherNet/IP	K 9 6		

SINAMICS G120P Cabinet		Line-side components			Recommended line-side overcurrent protection devices		
Rated power		SINAMICS G120P Cabinet	Line filter class A (Category C2)	Line Harmonics Filter	Line reactor	Fuse type 3NA3	Fuse type 3NE1 (VA)
400 V	460 V	Type	Only in combination with version A	Only in combination with version A		Article No.	Article No.
kW	hp		Order code	Order code			
75	75	6SL3710-1PE31-5AB0-Z	L00	L01	Installed in control cabinet as standard	3NA3140	3NE1225-0
90	100	6SL3710-1PE31-8AB0-Z				3NA3142	3NE1227-0
110	125	6SL3710-1PE32-1AB0-Z				3NA3250	3NE1230-0
132	150	6SL3710-1PE32-5AB0-Z				3NA3252	3NE1331-0
160	200	6SL3710-1PE33-0...				3NA3260	3NE1333-2
200	250	6SL3710-1PE33-7...				3NA3365	3NE1334-2
250	300	6SL3710-1PE34-6...				3NA3372	3NE1435-2
315	400	6SL3710-1PE35-8...				3NA3372	3NE1437-2
355	450	6SL3710-1PE36-6...				3NA3475	3NE1438-2
400	500	6SL3710-1PE37-4...				3NA3475	3NE1448-2
450	500	6SL3710-1PE38-4AA0-Z				3NA3480	3NE1334-3 (2 units)
500	600	6SL3710-1PE38-8AA0-Z				3NA3480	3NE1435-3 (2 units)
560	700	6SL3710-1PE41-0AA0-Z				3NA3482	3NE1436-3 (2 units)

¹⁾ Rated power based on the base-load current I_L . The base-load current I_L is based on the duty cycle for low overload (LO).

²⁾ The base-load current I_H is based on the duty cycle for high overload (HO).

Overview (continued)

SINAMICS G120P Cabinet for use in water/wastewater applications and in industrial environments,
with degree of protection IP20, 380 to 480 V 3 AC

SINAMICS G120P Cabinet		SINAMICS G120P Cabinet	DC link components	Load-side power components	
Rated power			Braking Module / braking resistor	Motor reactor	dv/dt filter compact plus VPL
400 V kW	460 V hp	Type	Order code	Order code	Order code
75	75	6SL3710-1PE31-5AB0-Z	L62	L08	L07
90	100	6SL3710-1PE31-8AB0-Z			
110	125	6SL3710-1PE32-1AB0-Z			
132	150	6SL3710-1PE32-5AB0-Z			
160	200	6SL3710-1PE33-0AA0-Z			
200	250	6SL3710-1PE33-7AA0-Z			
250	300	6SL3710-1PE34-6AA0-Z			
315	400	6SL3710-1PE35-8AA0-Z			
355	450	6SL3710-1PE36-6AA0-Z			
400	500	6SL3710-1PE37-4AA0-Z			
450	500	6SL3710-1PE38-4AA0-Z			
500	600	6SL3710-1PE38-8AA0-Z			
560	700	6SL3710-1PE41-0AA0-Z			

System configuration

SINAMICS G120P and SINAMICS G120P Cabinet pump, fan, compressor converters

Integrated Drive Systems

Overview (continued)

SINAMICS G120P Cabinet for use in water/wastewater applications and in industrial environments, with degree of protection IP20, 500 to 690 V 3 AC

SINAMICS G120P Cabinet						SINAMICS G120P Cabinet				Control Unit	Operator panel
Rated power ¹⁾		Rated output current I_{rated}	Power based on the base-load current I_H ²⁾		Base-load current I_H ²⁾	Frame size	Power Module Type	Version A All available line connection components can be installed as required	Version C Especially space-saving design	CU230P-2 (It is essential to specify one of the order codes below)	Intelligent Operator Panel IOP-2
690 V	575 V	A	kW	hp	A		Article No.	Article No.			
kW	hp	A	kW	hp	A					Order code	
315	350	340	250	250	272	HX	PM330	6SL3710-1PG33-7AA0-Z	6SL3710-1PG33-7CA0-Z	■ ■ ■	Installed in control cabinet as standard
355	400	393	315	300	314			6SL3710-1PG34-0AA0-Z	6SL3710-1PG34-0CA0-Z		
400	450	430	355	350	348			6SL3710-1PG34-5AA0-Z	6SL3710-1PG34-5CA0-Z		
450	450	480	400	450	394			6SL3710-1PG35-2AA0-Z	6SL3710-1PG35-2CA0-Z		
500	500	535	450	450	444	JX		6SL3710-1PG35-8AA0-Z	–		
560	600	595	500	500	476			6SL3710-1PG36-5AA0-Z	–		
630	700	655	560	500	532			6SL3710-1PG37-2AA0-Z	–		
SINAMICS G120P Control Unit								Fieldbus protocols			
CU230P-2 HVAC								USS, Modbus RTU, BACnet MS/TP, FLN P1		K 9 8	
CU230P-2 DP								PROFIBUS DP		K 9 7	
CU230P-2 PN								PROFINET, EtherNet/IP		K 9 6	

Rated power		SINAMICS G120P Cabinet	Line-side components			Recommended line-side overcurrent protection devices	
690 V	575 V	Type	Line filter class A (Category C2) Only in combination with version A	Line Harmonics Filter Only in combination with version A	Line reactor	Fuse type 3NA3	Fuse type 3NE1 (5A)
kW	hp		Order code	Order code		Article No.	Article No.
315	350	6SL3710-1PG33-7...	L00	L01	Installed in control cabinet as standard	3NA3360-6	3NE1333-2
355	400	6SL3710-1PG34-0...				3NA3362-6	3NE1334-2
400	450	6SL3710-1PG34-5...				3NA3365-6	3NE1435-2
450	450	6SL3710-1PG35-2...				3NA3352-6 (2 units)	3NE1436-2
500	500	6SL3710-1PG35-8...				3NA3354-6 (2 units)	3NE1437-2
560	600	6SL3710-1PG36-5...				3NA3360-6 (2 units)	3NE1438-2
630	700	6SL3710-1PG37-2...				3NA3362-6 (2 units)	3NE1448-2

Rated power		SINAMICS G120P Cabinet	DC link components	Load-side power components	
690 V	575 V	Type	Braking Module / braking resistor	Motor reactor	dv/dt filter compact plus VPL
kW	hp		Order code	Order code	Order code
315	350	6SL3710-1PG33-7AA0-Z	L62	L08	L07
355	400	6SL3710-1PG34-0AA0-Z			
400	450	6SL3710-1PG34-5AA0-Z			
450	450	6SL3710-1PG35-2AA0-Z			
500	500	6SL3710-1PG35-8AA0-Z			
560	600	6SL3710-1PG36-5AA0-Z			
630	700	6SL3710-1PG37-2AA0-Z			

¹⁾ Rated power based on the base-load current I_L . The base-load current I_L is based on the duty cycle for low overload (LO).

²⁾ The base-load current I_H is based on the duty cycle for high overload (HO).

SINAMICS G120P built-in and wall-mounted units, degrees of protection IP20 and IP55

4



	4/2	Control Units
	4/2	CU230P-2 Control Units
Use in building management systems (heating, air-conditioning, ventilation applications)	4/10	PM230 Power Modules, 0.37 kW to 90 kW
	4/10	PM230 Power Modules
	4/30	Line filter
	4/33	Recommended line-side overcurrent protection devices
	4/35	Output reactors
	4/40	Sine-wave filters
Use in water/wastewater and industrial applications	4/42	PM240P-2 Power Modules, 11 kW to 132 kW
	4/42	PM240P-2 Power Modules
	4/53	Recommended line-side overcurrent protection devices
	4/54	Output reactors
	4/56	dv/dt filters plus VPL
	4/58	PM330 Power Modules, 160 kW to 630 kW
	4/58	PM330 Power Modules
	4/74	Line filters
	4/76	Line reactors
	4/79	Recommended line-side power components
4/80	Braking Modules	
4/82	Braking resistors	
4/83	Output reactors	
4/85	dv/dt filters plus VPL	
4/88	dv/dt filters compact plus VPL	
	4/90	Supplementary system components
	4/100	Spare parts

SINAMICS G120P built-in and wall-mounted units

Control Units

CU230P-2 Control Units

Overview



Example: CU230P-2 PN Control Unit

The CU230P-2 Control Units are designed for drives with integrated technological functions for pump, fan and compressor applications. The I/O interface, the fieldbus interfaces and the additional software functions optimally support these applications.

Note:

Shield plates and shield connection kits are available. These can be used in the wiring installation for the Control Units and PM230/PM240P-2 Power Modules to ensure that it complies with EMC guidelines.

For more information, see [Shield connection kits and shield plates for Control Units and Power Modules](#) in section [Supplementary system components](#).

PM330 Power Modules are supplied with the accessories needed to create an EMC-compliant wiring installation for Control Units and Power Modules. The Control Unit mounting surface on the Power Modules has mounting slots for shielding terminals.

Function

Below is a list of functions sorted according to the following categories:

Control modes

- Linear and quadratic torque characteristic for fluid flow and positive displacement machines
- ECO mode for additional energy saving in U/f control mode
- Sensorless vector control for sophisticated control tasks and high-output motors

Connections

- 2 analog inputs (current/voltage can be selected) to directly connect pressure/level sensors
- 2 additional analog inputs to connect Pt1000/LG-Ni1000/DIN-Ni1000 temperature sensors
- Direct control of valves and flaps using two 230 V AC relays

Interfaces

- PROFINET, EtherNet/IP, PROFIBUS, USS, BACnet MS/TP, FLN P1, and Modbus-RTU communication

Software functions

- Automatic restart function after power failure
- Automatic restart
- Flying restart
- Skip frequencies
- 1 PID controller for the closed-loop control of the motor speed as process controller for temperature, pressure, air quality or levels
- 3 freely-programmable PID controllers
- Hibernation mode
- Load check function to monitor belts and flow
- Cascade connection
- Multi-zone controller
- Essential service mode
- Real time clock with three time generators

IOP-2 wizards for special applications with and without PID controller, such as

- Pumps: Positive displacement (constant load torque) and centrifugal pumps (quadratic load torque)
- Fans: Radial and axial fans (quadratic load torque)
- Compressors: Positive displacement (constant load torque) and fluid flow machines (quadratic load torque)

SINAMICS G120P built-in and wall-mounted units

Control Units

CU230P-2 Control Units

Design

CU230P-2 HVAC, CU230P-2 DP and CU230P-2 PN Control Units

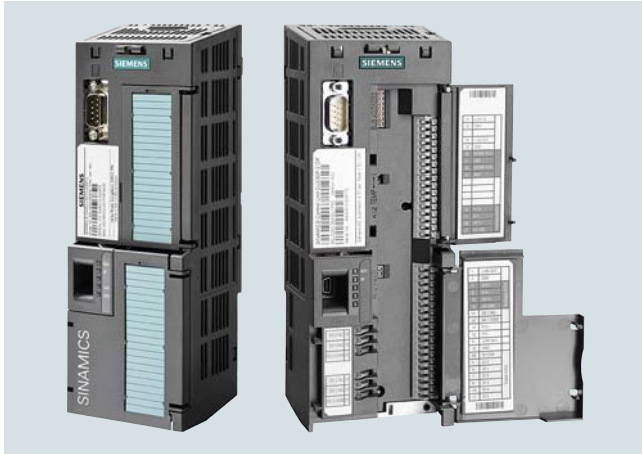

Example: CU230P-2 Control Unit with open and closed terminal covers

Terminal No.	Signal	Features
Digital inputs (DI) – Standard		
69	DI COM	Reference potential for digital inputs
5 ... 8, 16.17	DI0 ... DI5	Freely programmable isolated, inputs in compliance with IEC 61131-2
Digital outputs (DO)		
18	DO0, NC	Relay output 1 NC contact (5 A, 30 V DC or 2 A, 250 V AC) ¹⁾
19	DO0, NO	Relay output 1 NO contact (5 A, 30 V DC or 2 A, 250 V AC)
20	DO0, COM	Relay output 1 Common contact (5 A, 30 V DC or 2 A, 250 V AC) ¹⁾
21	DO1, NO	Relay output 2 NO contact (0.5 A, 30 V DC)
22	DO1, COM	Relay output 2 Common contact (0.5 A, 30 V DC)
23	DO2, NC	Relay output 3 NC contact (5 A, 30 V DC or 2 A, 250 V AC) ¹⁾
24	DO2, NO	Relay output 3 NO contact (5 A, 30 V DC or 2 A, 250 V AC)
25	DO2, COM	Relay output 3 Common contact (5 A, 30 V DC or 2 A, 250 V AC) ¹⁾

¹⁾ The following applies to systems complying with UL: A maximum of 3 A, 30 V DC or 2 A, 250 V AC may be connected via terminals 18 / 20 (DO0 NC) and 23 / 25 (DO2 NC).

Terminal No.	Signal	Features
Analog inputs (AI)		
3	AI0+	Differential input, switchable between current and voltage Value range: 0 ... 10 V, -10 ... +10 V, 0/2 ... 10 V, 0/4 ... 20 mA
4	AI0-	
10	AI1+	Differential input, switchable between current and voltage Value range: 0 ... 10 V, -10 ... +10 V, 0/2 ... 10 V, 0/4 ... 20 mA
11	AI1-	
50	AI2+	Non-isolated input, switchable between current and temperature sensors, type Pt1000/LG-Ni1000/DIN-Ni1000 Value range: 0/4 ... 20 mA, Pt1000: -88 ... +240 °C (-126 ... +464 °F) LG-Ni1000/DIN-Ni1000: -88 ... +165 °C (-126 ... +329 °F)
51	GND	Reference potential of the AI2/internal electronics ground
52	AI3+	Non-isolated input for temperature sensors, type Pt1000/LG-Ni1000/DIN-Ni1000 Value range: Pt1000: -88 ... +240 °C (-126 ... 464 °F) LG-Ni1000/DIN-Ni1000: -88 ... +165 °C (-126 ... 329 °F)
53	GND	Reference potential of the AI3/internal electronics ground
Analog outputs (AO)		
12	AO0+	Non-isolated output Freely programmable Value range: 0 ... 10 V; 0/4 ... 20 mA
13	GND	Reference potential of the AO0/internal electronics ground
26	AO1+	Non-isolated output Freely programmable Value range: 0 ... 10 V; 0/4 ... 20 mA
27	GND	Reference potential of the AO1/internal electronics ground
Motor temperature sensor interface		
14	T1 MOTOR	Positive input for motor temperature sensor Type: PTC, Pt1000, KTY sensor, bimetal
15	T2 MOTOR	Negative input for motor temperature sensor
Power supply		
9	+24 V OUT	Power supply output 24 V DC, max. 100 mA
28	GND	Reference potential of the power supply/internal electronics ground
1	+10 V OUT	Power supply output 10 V DC ±0.5 V, max. 10 mA
2	GND	Reference potential of the power supply/internal electronics ground
31	+24 V IN	Power supply input 20.4 ... 28.8 V DC, max. 1500 mA
32	GND IN	Reference potential of the power supply input
35	+10 V OUT	Power supply output 10 V DC ±0.5 V, max. 10 mA
36	GND	Reference potential of the power supply/internal electronics ground

SINAMICS G120P built-in and wall-mounted units

Control Units

CU230P-2 Control Units

Integration

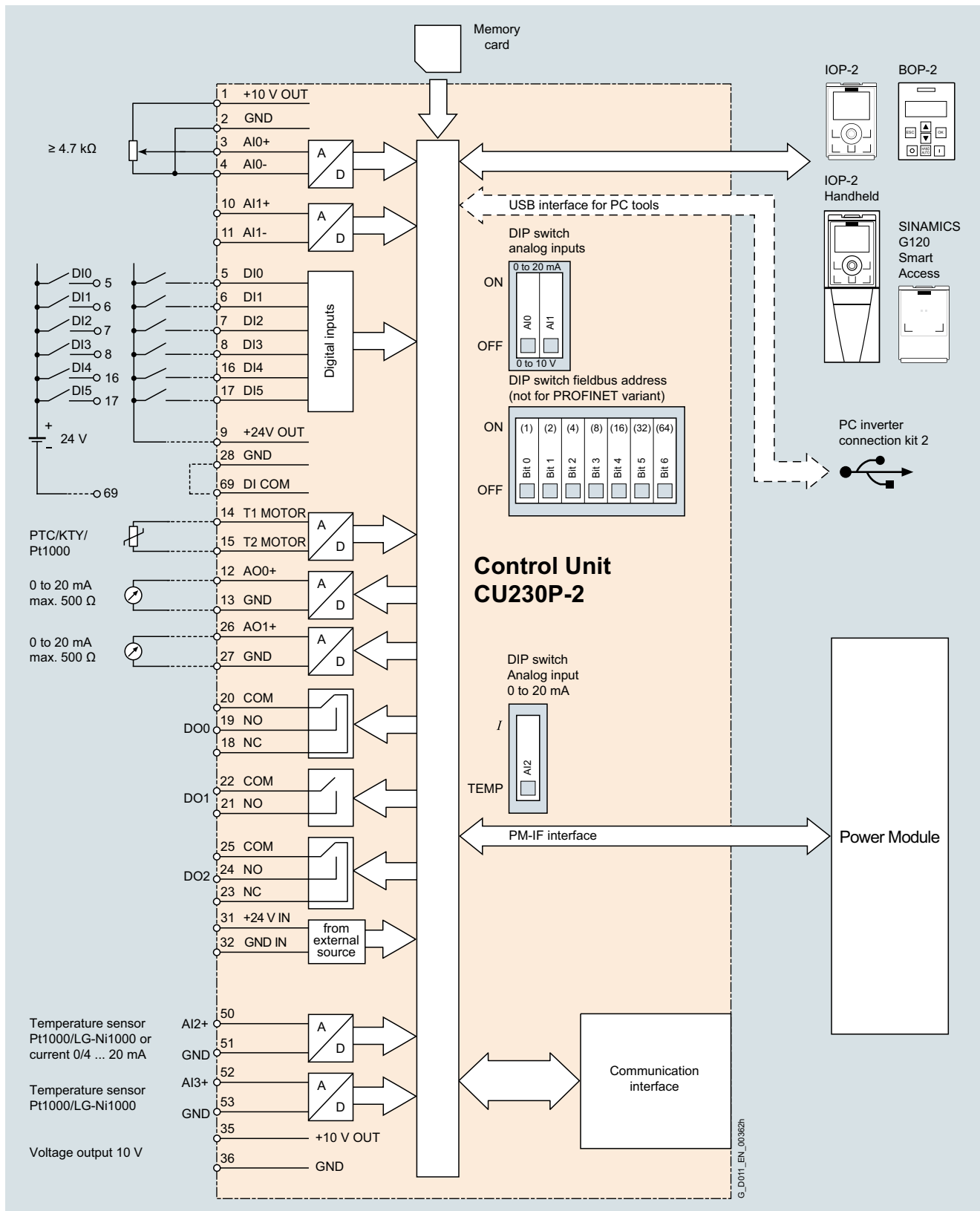

Connection diagram for the CU230P-2 Control Unit series

More information about the interfaces of the Control Unit is available on the Internet at <https://support.industry.siemens.com/cs/document/109477360>

Integration (continued)

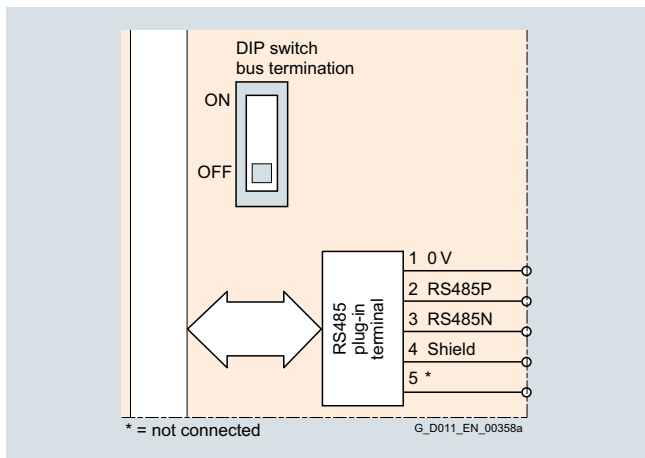

Communication interface USS, Modbus RTU, BACnet MS/TP, FLN P1 for CU230P-2 HVAC

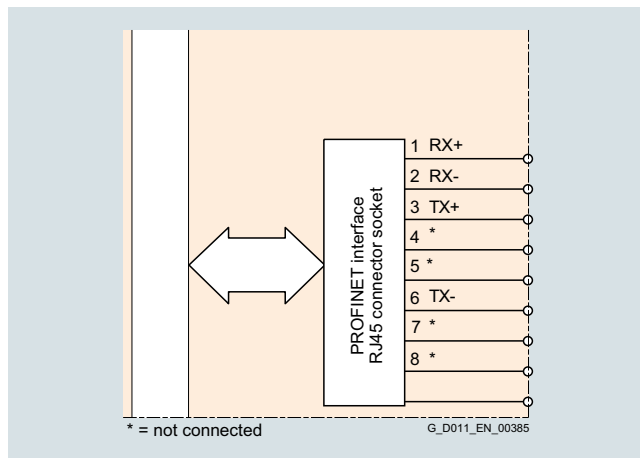

PROFINET communication interface, EtherNet/IP

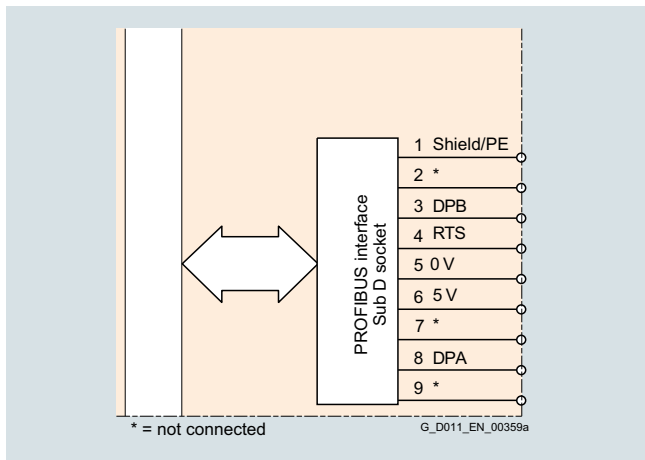

PROFIBUS DP communication interface

SINAMICS G120P built-in and wall-mounted units

Control Units

CU230P-2 Control Units

Selection and ordering data

Fieldbus	Profile	Inputs	Outputs	Integrated safety technology	Designation	Control Unit Article No.
CU230P-2 series – the specialist for pumps, fans, compressors, water, buildings						
Technology functions (selection):						
Free blocks (FFB), 4 × PID controller, cascade connection, hibernation mode, essential service mode, multi-zone control						
<ul style="list-style-type: none"> • USS • Modbus RTU • BACnet MS/TP • FLN P1 	–	6 digital 4 analog	3 digital 2 analog	–	CU230P-2 HVAC	6SL3243-0BB30-1HA3
<ul style="list-style-type: none"> • PROFIBUS DP 	<ul style="list-style-type: none"> • PROFIdrive 				CU230P-2 DP	6SL3243-0BB30-1PA3
<ul style="list-style-type: none"> • PROFINET 	<ul style="list-style-type: none"> • PROFIdrive • PROFlenergy 				CU230P-2 PN	6SL3243-0BB30-1FA0
<ul style="list-style-type: none"> • EtherNet/IP - ODVA AC drive - SINAMICS profile 	–					

Optional firmware memory cards for CU230P-2 Control Units

Designation	Article No.
SINAMICS SD card 512 MB + firmware V4.7 SP9 (Multicard V4.7 SP9)	6SL3054-7TE00-2BA0
SINAMICS SD card 512 MB + firmware V4.7 SP10 (Multicard V4.7 SP10)	NEW 6SL3054-7TF00-2BA0

For more information about firmware V4.7 SP9: <https://support.industry.siemens.com/cs/document/109750805>

For more information about firmware V4.7 SP10: <https://support.industry.siemens.com/cs/document/109755811>

SINAMICS G120P built-in and wall-mounted units

Control Units

CU230P-2 Control Units

Technical specifications

Control Unit	CU230P-2 HVAC	CU230P-2 DP	CU230P-2 PN
	6SL3243-0BB30-1HA3	6SL3243-0BB30-1PA3	6SL3243-0BB30-1FA0
Electrical specifications			
Operating voltage	24 V DC via the Power Module or by connecting to an external 20.4 ... 28.8 V DC power supply		
Current consumption, max.	0.5 A		
Protective insulation	PELV according to EN 50178 Protective separation from the line supply using double/reinforced insulation		
Power loss, max.	5 W		
Interfaces			
Digital inputs – Standard	6 isolated inputs, optically isolated; free reference potential (own potential group) NPN/PNP logic can be selected using the wiring		
<ul style="list-style-type: none"> Switching level: 0 → 1 Switching level: 1 → 0 Input current 	11 V 5 V 5.5 mA		
Digital outputs	3 relays		
<ul style="list-style-type: none"> 2 relay changeover contacts 	250 V AC, 2 A (inductive load) 30 V DC, 5 A (ohmic load) The following applies to UL-compliant installations: A maximum of 3 A, 30 V DC or 2 A, 250 V AC may be connected via terminals 18 / 20 (DO0 NC) and 23 / 25 (DO2 NC).		
<ul style="list-style-type: none"> 1 relay NO contact 	30 V DC, 0.5 A (ohmic load)		
Analog inputs	Analog inputs are protected against inputs in a voltage range of ± 30 V and have a common-mode voltage in the ± 15 V range		
<ul style="list-style-type: none"> 2 differential inputs 	Switchable with DIP switch between voltage and current: -10 ... +10 V, 0/4 ... 20 mA, 12-bit resolution These differential inputs can be configured as additional digital inputs. Switching thresholds: 0 → 1: Rated voltage 4 V 1 → 0: Rated voltage 1.6 V		
<ul style="list-style-type: none"> 1 non-isolated input 	Switchable with DIP switch between 0/4 ... 20 mA current and temperature sensors, type Pt1000/LG-Ni1000/DIN-Ni1000, 12-bit resolution		
<ul style="list-style-type: none"> 1 non-isolated input 	Temperature sensors, type Pt1000/LG-Ni1000/DIN-Ni1000, 12-bit resolution		
Analog outputs	The analog outputs have short-circuit protection		
<ul style="list-style-type: none"> 2 non-isolated outputs 	Switchable between voltage and current using parameter setting: 0 ... 10 V, 0/4 ... 20 mA Voltage mode: 10 V, min. burden 10 kΩ Current mode: 20 mA, max. burden 500 Ω		
PTC/KTY interface	1 motor temperature sensor input, connectable sensors PTC, Pt1000, KTY and bimetal, accuracy ±5 °C		
Bus interface			
Fieldbus protocols	<ul style="list-style-type: none"> USS Modbus RTU BACnet MS/TP FLN P1 (switchable using software) 	<ul style="list-style-type: none"> PROFIBUS DP 	<ul style="list-style-type: none"> PROFINET EtherNet/IP - ODVA AC drive - SINAMICS profile
Profile	–	<ul style="list-style-type: none"> PROFIdrive 	<ul style="list-style-type: none"> PROFIdrive PROFIenergy
Hardware	Plug-in terminal, insulated, USS: max. 187.5 kBaud Modbus RTU: 19.2 kBaud, Bus terminating resistor that can be switched in	9-pin SUB-D socket, insulated, max. 12 Mbit/s Slave address can be set using DIP switches	2 × RJ45, PROFIdrive profile V4.1, device name can be stored on the device Max. 100 Mbit/s (full duplex)

SINAMICS G120P built-in and wall-mounted units

Control Units

CU230P-2 Control Units

Technical specifications (continued)

Control Unit	CU230P-2 HVAC	CU230P-2 DP	CU230P-2 PN
	6SL3243-0BB30-1HA3	6SL3243-0BB30-1PA3	6SL3243-0BB30-1FA0
Tool interfaces			
Memory card	SINAMICS SD card		
Operator panels	<ul style="list-style-type: none"> Intelligent Operator Panel IOP-2 Basic Operator Panel BOP-2 Blanking cover 		
	<ul style="list-style-type: none"> Can be directly plugged on Can be directly plugged on Required when no operator panel is plugged in order to achieve degree of protection IP55 on PM230 Power Modules degree of protection IP55/UL Type 12 		
PC interface	USB (connection via PC inverter connection kit 2)		
Open-loop/closed-loop control techniques			
U/f linear/quadratic/parameterizable	✓		
U/f with flux current control (FCC)	✓		
U/f ECO; linear/quadratic	✓		
Vector control, sensorless	✓		
Software functions			
Setpoint input	✓		
Fixed frequencies	16, parameterizable		
JOG	✓		
Digital motorized potentiometer (MOP)	✓		
Ramp smoothing	✓		
Extended ramp-function generator (with ramp smoothing OFF3)	✓		
Slip compensation	✓		
Signal interconnection with BICO technology	✓		
Free function blocks (FFB) for logical and arithmetic operations	✓		
Switchable drive data sets (DDS)	✓ (4)		
Switchable command data sets (CDS)	✓ (4)		
Flying restart	✓		
Automatic restart after line supply failure or operating fault (AR)	✓		
Technology controller (internal PID)	✓		
Hibernation mode with internal/external PID controller	✓		
Belt monitoring with and without sensor (load torque monitoring)	✓		
Dry-running/overload protection monitoring (load torque monitoring)	✓		
Thermal motor protection	✓ (I^2t , sensor: PTC/Pt1000/KTY/bimetal)		
Thermal inverter protection	✓		
Motor identification	✓		
Auto-ramping (V_{dcmax} controller)	✓		
Kinetic buffering (V_{dcmin} controller)	✓		
Possible braking functions	<ul style="list-style-type: none"> DC braking (PM230, PM240P-2, PM330, Cabinet) Compound braking (PM240P-2) Dynamic braking with optional Braking Module and braking resistor (PM330, Cabinet) 		

SINAMICS G120P built-in and wall-mounted units

Control Units

CU230P-2 Control Units

Technical specifications (continued)

Control Unit	CU230P-2 HVAC	CU230P-2 DP	CU230P-2 PN
	6SL3243-0BB30-1HA3	6SL3243-0BB30-1PA3	6SL3243-0BB30-1FA0
Mechanical specifications and ambient conditions			
Degree of protection	IP20		
Signal cable cross-section	0.15 ... 1.5 mm ² (AWG28 ... AWG16)		
Operating temperature	For CU230P-2 HVAC/DP: -10 ... 60 °C (14 ... 140 °F) For CU230P-2 PN: -10 ... 55 °C (14 ... 131 °F) With IOP-2/BOP-2: 0 ... 50 °C (32 ... 122 °F) Derating of 3 K/1000 m applies to Control Units as of an installation altitude of 1000 m (3281 ft) above sea level.		
Storage temperature	-40 ... +70 °C (-40 ... +158 °F)		
Relative humidity	<95 %, condensation not permissible		
Dimensions			
• Width	73 mm (2.87 in)		
• Height	199 mm (7.83 in)		
• Depth	65.5 mm (2.58 in)		
Weight, approx.	0.61 kg (1.34 lb)		

SINAMICS G120P built-in and wall-mounted units

PM230 Power Modules, 0.37 kW to 90 kW

PM230 Power Modules

Overview

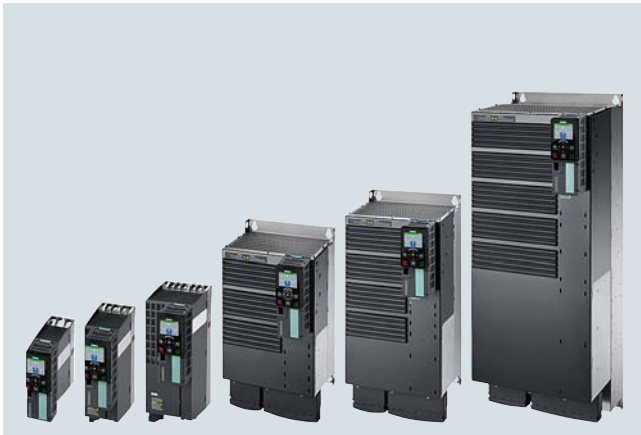

PM230 Power Modules, degree of protection IP20, frame sizes FSA to FSF (with Control Unit and operator panel)



PM230 Power Modules, degree of protection IP20, Push Through variant, frame sizes FSA to FSC (with Control Unit and operator panel)



PM230 Power Modules, degree of protection IP55, frame sizes FSA to FSF (without Control Unit and without operator panel/blanking cover)

PM230 Power Modules are designed for applications involving pumps, fans and compressors with a quadratic characteristic. They do not have an integrated braking chopper (single-quadrant applications).

The PM230 Power Module only generates low line harmonics and apparent power losses. In addition to the energy-related advantages, environmental stressing is also reduced.

- Line harmonics are reduced significantly.
 - The limit values of EN 61000-3-12 are complied with for $R_{SCE} > 250$. R_{SCE} is the short-circuit power ratio $\frac{S_{sc\ line}}{S_{inverter}}$ acc. to EN 61000-3-12 and is identical to R_{SC} acc. to IEC 60146-1-1 in the case of three-phase devices.
 - Additional components such as line reactors are not required and it is not permissible to use them. As a consequence, low envelope dimensions are obtained for space-saving designs.
- The active power component is very high, i.e. the devices consume less current from the supply for the same drive power. As a consequence, smaller supply cables can be used.

Frame sizes FSA to FSF of the PM230 Power Module in degree of protection IP55 are available with integrated line filter class A for installations acc. to Category C2 and in accordance with EN 61800-3. The PM230 Power Modules with integrated filter class B that are available as an alternative also comply with the conducted interference requirements for Category C1 in accordance with EN 61800-3.

¹⁾ More information on the CU240E-2 Control Unit is available in Catalog D 31.1, Chapter SINAMICS G120. An adapter, article number 10055500 (ordered from and supplied by KnorrTec at www.knorrtec.com), is required to operate a PM230 Power Module with degree of protection IP55 in combination with a CU240E-2 Control Unit and an IOP-2/BOP-2.

Frame sizes FSA to FSF of the PM230 Power Module in degree of protection IP20 are available with integrated line filter class A for Category C2 installations in accordance with EN 61800-3, or without an integrated line filter.

The frame sizes FSA to FSC of the PM230 Power Module with degree of protection IP20, Push Through version, are available with integrated line filter class A for installations acc. to Category C2 as per EN 61800-3 or without an integrated line filter.

PM230 Power Modules with integrated line filter class A or class B meet the EMC limit values up to a maximum cable length of 25 m (82 ft) with shielded cables between inverter and motor.

Unfiltered PM230 Power Modules with degree of protection IP20 with external line filter class B comply with EMC Category C1 with a cable length of 50 m (164 ft) between the inverter and the motor. EMC Category C2 is complied with through the use of an additional output reactor for a cable length of 150 m (492 ft) ([see output-side power components](#)).

The line system configurations that are supported are symmetrical systems with grounded neutral point.

PM230 Power Modules in frame sizes FSA to FSC can be combined with the CU240E-2 Control Unit ¹⁾. This enables the implementation of the STO safety function acc. to SIL 2.

PM230 Power Modules, frame sizes FSD to FSF, do not support Control Units with Safety Integrated. Safety functions can be implemented here by means of external switching devices.

SINAMICS G120P built-in and wall-mounted units

PM230 Power Modules, 0.37 kW to 90 kW

PM230 Power Modules

Overview (continued)

Note:

Shield plates and shield connection kits are available. These can be used in the wiring installation for the Control Units and Power Modules to ensure that it complies with EMC guidelines.

For more information, see Shield connection kits and Shield plates for Control Units and Power Modules in section Supplementary system components.

Integration

PM230 Power Modules have the following connections and interfaces:

- PM-IF interface for connection of the PM230 Power Module and Control Unit. The PM230 Power Module also supplies power to the Control Unit using an integrated power supply.
- Motor connection using screw-type terminals or screw studs
- 2 PE/protective conductor connections

PM230 Power Modules communicate with the Control Unit via the PM-IF interface.

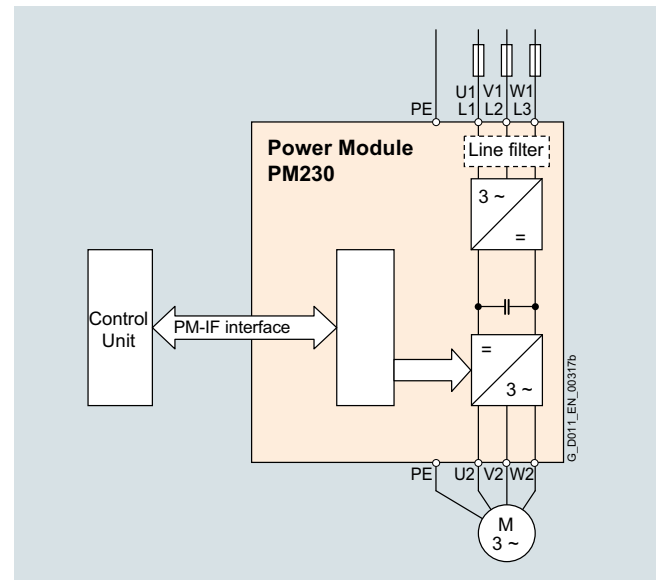

Connection diagram for PM230 Power Module with or without integrated line filter class A or B

Power components that are optionally available depending on the Power Module used

The following line-side and load-side power components are optionally available in the appropriate frame sizes for the Power Modules:

	Frame size					
	FSA	FSB	FSC	FSD	FSE	FSF
PM230 Power Module (IP55)						
Available frame sizes	✓	✓	✓	✓	✓	✓
Line-side power components						
Line filter class A	I	I	I	I	I	I
Line filter class B	I	I	I	I	I	I
Line reactor ¹⁾	- ¹⁾	- ¹⁾	- ¹⁾	- ¹⁾	- ¹⁾	- ¹⁾
Load-side power components						
Output reactor	S	S	S	S	S	S
Sine-wave filter	-	-	-	S	S	S
PM230 Power Module (IP20)						
Available frame sizes	✓	✓	✓	✓	✓	✓
Line-side power components						
Line filter class A	F	F	F	F	F	F
Line filter class B	U ²⁾	U ²⁾	U ²⁾	S	S	S
Line reactor ¹⁾	- ¹⁾	- ¹⁾	- ¹⁾	- ¹⁾	- ¹⁾	- ¹⁾
Load-side power components						
Output reactor	S	S	S	S	S	S
Sine-wave filter	-	-	-	S	S	S

U = Base component

S = Lateral mounting

I = Integrated

F = Power Modules available with and without integrated filter class A

- = Not possible

¹⁾ A line reactor is not required and must not be used in conjunction with a PM230 Power Module.

²⁾ Lateral mounting is the only possible option for Push Through variants.

SINAMICS G120P built-in and wall-mounted units

PM230 Power Modules, 0.37 kW to 90 kW

PM230 Power Modules

Integration (continued)

Maximum permissible cable lengths from the motor to the inverter when using output reactors or filters depending on the voltage range and the Power Module being used

The following load-side power components in the appropriate frame sizes are optionally available for the Power Modules and result in the following maximum cable lengths:

Frame size	Maximum permissible motor cable lengths (shielded/unshielded) in m (ft)					
	FSA	FSB	FSC	FSD	FSE	FSF
PM230 Power Module degree of protection IP20						
Available frame sizes	✓	✓	✓	✓	✓	✓
Without output reactor/sine-wave filter	25/100 (82/328)	25/100 (82/328)	25/100 (82/328)	25/100 (82/328)	25/100 (82/328)	25/100 (82/328)
With optional output reactor						
• At 380 ... 415 V 3 AC	150/225 (492/738)	150/225 (492/738)	150/225 (492/738)	–	–	–
• At 440 ... 480 V 3 AC	100/150 (328/492)	100/150 (328/492)	100/150 (328/492)	–	–	–
• At 380 ... 480 V 3 AC	–	–	–	200/300 (656/984)	200/300 (656/984)	200/300 (656/984)
With optional sine-wave filter						
• At 380 ... 480 V 3 AC	–	–	–	200/300 (656/984)	200/300 (656/984)	200/300 (656/984)
With integrated line filter class A (EMC category C3)						
• At 380 ... 480 V 3 AC	50/- (164/-)	50/- (164/-)	50/- (164/-)	50/- (164/-)	50/- (164/-)	50/- (164/-)
With optional external line filter class B (EMC category C1¹⁾, with unfiltered Power Module, maintains the limit values acc. to EN 61800-3)						
• At 380 ... 480 V 3 AC	50/- (164/-)	50/- (164/-)	50/- (164/-)	50/- (164/-)	50/- (164/-)	50/- (164/-)
With optional external line filter class B and output reactor (EMC category C2¹⁾, with unfiltered Power Module, maintains the limit values acc. to EN 61800-3)						
• At 380 ... 415 V 3 AC	150/- (492/-)	150/- (492/-)	150/- (492/-)	–	–	–
• At 440 ... 480 V 3 AC	100/- (328/-)	100/- (328/-)	100/- (328/-)	–	–	–

¹⁾ More information is available on the Internet at www.siemens.com/sinamics-g120/documentation

SINAMICS G120P built-in and wall-mounted units

PM230 Power Modules, 0.37 kW to 90 kW

PM230 Power Modules

Selection and ordering data

To ensure that a suitable Power Module is selected, the following currents should be used for applications:

- **Rated output current for applications with low overload (LO)**
- **Base-load current for applications with high overload (HO)**

With reference to the rated output current, the modules support at least 2-pole to 6-pole low-voltage motors, e.g. the SIMOTICS GP and SIMOTICS SD 1LE1 motor series. The rated power is merely a guide value. For a description of the overload performance, please refer to the general technical specifications of the Power Modules.

PM230 Power Modules degree of protection IP55/UL Type 12

Rated power ¹⁾		Rated output current I_{rated} ²⁾	Power based on the base-load current ³⁾		Base-load current I_H ³⁾	Frame size	PM230 Power Module degree of protection IP55/UL Type 12 with integrated line filter class <u>A</u>	PM230 Power Module degree of protection IP55/UL Type 12 with integrated line filter class <u>B</u>
400 V	460 V		400 V	460 V				
kW	hp	A	kW	hp	A	Article No.	Article No.	
380 ... 480 V 3 AC								
0.37	0.5	1.3	0.25	0.33	0.9	FSA	6SL3223-0DE13-7AG1	6SL3223-0DE13-7BG1
0.55	0.5	1.7	0.37	0.33	1.3	FSA	6SL3223-0DE15-5AG1	6SL3223-0DE15-5BG1
0.75	0.75	2.2	0.55	0.5	1.7	FSA	6SL3223-0DE17-5AG1	6SL3223-0DE17-5BG1
1.1	1	3.1	0.75	0.75	2.2	FSA	6SL3223-0DE21-1AG1	6SL3223-0DE21-1BG1
1.5	2	4.1	1.1	1	3.1	FSA	6SL3223-0DE21-5AG1	6SL3223-0DE21-5BG1
2.2	3	5.9	1.5	1.5	4.1	FSA	6SL3223-0DE22-2AG1	6SL3223-0DE22-2BG1
3	3	7.7	2.2	3	5.9	FSA	6SL3223-0DE23-0AG1	6SL3223-0DE23-0BG1
4	5	10.2	3	3	7.7	FSB	6SL3223-0DE24-0AG1	6SL3223-0DE24-0BG1
5.5	7.5	13.2	4	5	10.2	FSB	6SL3223-0DE25-5AG1	6SL3223-0DE25-5BG1
7.5	10	18	5.5	5	13.2	FSB	6SL3223-0DE27-5AG1	6SL3223-0DE27-5BG1
11	15	26	7.5	10	18	FSC	6SL3223-0DE31-1AG1	6SL3223-0DE31-1BG1
15	15	32	11	15	26	FSC	6SL3223-0DE31-5AG1	6SL3223-0DE31-5BG1
18.5	20	38	15	15	32	FSC	6SL3223-0DE31-8AG1	–
						FSD	–	6SL3223-0DE31-8BA0
22	25	45	18.5	20	38	FSD	6SL3223-0DE32-2AA0	6SL3223-0DE32-2BA0
30	30	60	22	25	45	FSD	6SL3223-0DE33-0AA0	6SL3223-0DE33-0BA0
37	40	75	30	30	60	FSE	6SL3223-0DE33-7AA0	6SL3223-0DE33-7BA0
45	50	90	37	40	75	FSE	6SL3223-0DE34-5AA0	6SL3223-0DE34-5BA0
55	60	110	45	50	90	FSF	6SL3223-0DE35-5AA0	6SL3223-0DE35-5BA0
75	75	145	55	60	110	FSF	6SL3223-0DE37-5AA0	6SL3223-0DE37-5BA0
90	100	178	75	75	145	FSF	6SL3223-0DE38-8AA0	6SL3223-0DE38-8BA0

It is essential to plug on an operator panel or the blanking cover in order to achieve degree of protection IP55/UL Type 12.

For more information, see [Operator panels and Blanking cover for PM230 Power Modules](#) in section [Supplementary system components](#).

Note:

The power data in hp units are based on the NEC/CEC standards for the North American market.

¹⁾ Rated power based on the rated output current I_{rated} . The rated output current I_{rated} is based on the duty cycle for low overload (LO).

²⁾ The rated output current I_{rated} is based on the duty cycle for low overload (LO). These current values are valid for 400 V and are specified on the rating plate of the Power Module.

³⁾ The base-load current I_H is based on the duty cycle for high overload (HO).

SINAMICS G120P built-in and wall-mounted units

PM230 Power Modules, 0.37 kW to 90 kW

PM230 Power Modules

Selection and ordering data (continued)

PM230 Power Modules degree of protection IP20 Standard variant

Rated power ¹⁾		Rated output current I_{rated} ²⁾ A	Power based on the base-load current ³⁾		Base-load current I_H ³⁾ A	Frame size	PM230 Power Module degree of protection IP20 Standard variant without integrated line filter Article No.	PM230 Power Module degree of protection IP20 Standard variant with integrated line filter class A Article No.
400 V kW	460 V hp		400 V kW	460 V hp				
380 ... 480 V 3 AC								
0.37	0.5	1.3	0.25	0.33	0.9	FSA	6SL3210-1NE11-3UG1	6SL3210-1NE11-3AG1
0.55	0.5	1.7	0.37	0.33	1.3	FSA	6SL3210-1NE11-7UG1	6SL3210-1NE11-7AG1
0.75	0.75	2.2	0.55	0.5	1.7	FSA	6SL3210-1NE12-2UG1	6SL3210-1NE12-2AG1
1.1	1	3.1	0.75	0.75	2.2	FSA	6SL3210-1NE13-1UG1	6SL3210-1NE13-1AG1
1.5	2	4.1	1.1	1	3.1	FSA	6SL3210-1NE14-1UG1	6SL3210-1NE14-1AG1
2.2	3	5.9	1.5	1.5	4.1	FSA	6SL3210-1NE15-8UG1	6SL3210-1NE15-8AG1
3	3	7.7	2.2	3	5.9	FSA	6SL3210-1NE17-7UG1	6SL3210-1NE17-7AG1
4	5	10.2	3	3	7.7	FSB	6SL3210-1NE21-0UG1	6SL3210-1NE21-0AG1
5.5	7.5	13.2	4	5	10.2	FSB	6SL3210-1NE21-3UG1	6SL3210-1NE21-3AG1
7.5	10	18	5.5	5	13.2	FSB	6SL3210-1NE21-8UG1	6SL3210-1NE21-8AG1
11	15	26	7.5	10	18	FSC	6SL3210-1NE22-6UG1	6SL3210-1NE22-6AG1
15	15	32	11	15	26	FSC	6SL3210-1NE23-2UG1	6SL3210-1NE23-2AG1
18.5	20	38	15	15	32	FSC	6SL3210-1NE23-8UG1	6SL3210-1NE23-8AG1
22	25	45	18.5	20	38	FSD	6SL3210-1NE24-5UL0	6SL3210-1NE24-5AL0
30	30	60	22	25	45	FSD	6SL3210-1NE26-0UL0	6SL3210-1NE26-0AL0
37	40	75	30	30	60	FSE	6SL3210-1NE27-5UL0	6SL3210-1NE27-5AL0
45	50	90	37	40	75	FSE	6SL3210-1NE28-8UL0	6SL3210-1NE28-8AL0
55	60	110	45	50	90	FSF	6SL3210-1NE31-1UL0	6SL3210-1NE31-1AL0
75	75	145	55	60	110	FSF	6SL3210-1NE31-5UL0	6SL3210-1NE31-5AL0

PM230 Power Modules degree of protection IP20 Push Through variant

Rated power ¹⁾		Rated output current I_{rated} ²⁾ A	Power based on the base-load current ³⁾		Base-load current I_H ³⁾ A	Frame size	PM230 Power Module degree of protection IP20 Push Through variant without integrated line filter Article No.	PM230 Power Module degree of protection IP20 Push Through variant with integrated line filter class A Article No.
400 V kW	460 V hp		400 V kW	460 V hp				
380 ... 480 V 3 AC								
3	3	7.7	2.2	3	5.9	FSA	6SL3211-1NE17-7UG1	6SL3211-1NE17-7AG1
7.5	10	18	5.5	5	13.2	FSB	6SL3211-1NE21-8UG1	6SL3211-1NE21-8AG1
18.5	20	38	15	15	32	FSC	6SL3211-1NE23-8UG1	6SL3211-1NE23-8AG1

Note:

The power data in hp units are based on the NEC/CEC standards for the North American market.

¹⁾ Rated power based on the rated output current I_{rated} . The rated output current I_{rated} is based on the duty cycle for low overload (LO).
²⁾ The rated output current I_{rated} is based on the duty cycle for low overload (LO). These current values are valid for 400 V and are specified on the rating plate of the Power Module.

³⁾ The base-load current I_H is based on the duty cycle for high overload (HO).

SINAMICS G120P built-in and wall-mounted units

PM230 Power Modules, 0.37 kW to 90 kW

PM230 Power Modules

Technical specifications

General technical specifications

	PM230 Power Modules	
Degree of protection	IP55 (with IOP-2, BOP-2 or blanking cover)	IP20/UL Open Type (Standard or Push Through variants)
Power (low overload LO)	0.37 ... 90 kW	0.37 ... 75 kW
Rated output current (low overload LO)	1.3 ... 178 A	1.3 ... 145 A
Power (high overload HO)	0.25 ... 75 kW	0.25 ... 55 kW
Rated output current (high overload HO)	0.9 ... 145 A	0.9 ... 110 A
System operating voltage	380 ... 480 V \pm 10 % 3 AC	
Grid requirement	>100	
Short-circuit power R_{SC}		
Input frequency	47 ... 63 Hz	
Output frequency	<ul style="list-style-type: none"> Control mode V/f: 0 ... 550 Hz Control type Vector: 0 ... 240 Hz 	
Pulse frequency	4 kHz for higher pulse frequencies up to 16 kHz, see derating data	
Power factor λ	0.9	
Offset factor $\cos \varphi$	0.95	
Inverter efficiency	\leq 97 %	
Output voltage, max. as % of input voltage	95 %	
Overload capability	<ul style="list-style-type: none"> Low overload (LO) <ul style="list-style-type: none"> Frame sizes FSA to FSC: Note: When the overload capability is used, the base-load current I_L is not reduced. 1.5 \times base-load current I_L (i. e. 150 % overload) for 3 s plus 1.1 \times base-load current I_L (i. e. 110 % overload) for 57 s within a cycle time of 300 s Frame sizes FSD to FSF: 1.1 \times base-load current I_L (i. e. 110 % overload) for 60 s within a cycle time of 300 s High overload (HO) <ul style="list-style-type: none"> Frame sizes FSA to FSC: Note: When the overload capability is used, the base-load current I_H is not reduced. 2 \times base-load current I_H (i. e. 200 % overload) for 3 s plus 1.5 \times base-load current I_H (i. e. 150 % overload) for 57 s within a cycle time of 300 s Frame sizes FSD to FSF: 1.5 \times base-load current I_H (i. e. 150 % overload) for 60 s within a cycle time of 300 s 	
Electromagnetic compatibility	<ul style="list-style-type: none"> Devices with line filter class A for applications according to Categories C3 and C2 Devices with line filter class B for applications according to Category C2 and compliance with conducted interference requirements of Category C1 	<ul style="list-style-type: none"> Devices without line filter Devices with line filter class A for applications according to Categories C3 and C2 Devices with line filter class B for applications according to Category C2 and compliance with conducted interference requirements of Category C1
Possible braking methods	DC braking	
Operating temperature	<ul style="list-style-type: none"> Low overload (LO) <ul style="list-style-type: none"> Frame sizes FSA to FSC: -10 ... +40 °C (14 ... 104 °F) without derating Frame sizes FSD to FSF: 0 ... 40 °C (32 ... 104 °F) without derating >40 ... 60 °C (104 ... 140 °F) see derating characteristics High overload (HO) <ul style="list-style-type: none"> Frame sizes FSA to FSC: -10 ... +50 °C (14 ... 122 °F) without derating Frame sizes FSD to FSF: 0 ... 50 °C (32 ... 122 °F) without derating >50 ... 60 °C (122 ... 140 °F) see derating characteristics 	
Relative humidity	<95 %, condensation not permissible	
Storage temperature	-40 ... +70 °C (-40 ... +158 °F)	
Cooling	Power units with increased air cooling using integrated fans	
Installation altitude	Up to 1000 m (3281 ft) above sea level without derating, > 1000 m (3281 ft) see derating characteristics	
Protection functions	<ul style="list-style-type: none"> Undervoltage Overvoltage Overcurrent/overload Overtemperature Ground fault Short-circuit Stall protection Motor blocking protection Motor overtemperature Inverter overtemperature Parameter locking 	
Rated short-circuit current $SCCR$ (Short-Circuit Current Rating) ¹⁾	Frame sizes FSA to FSC: 40 kA	65 kA
Compliance with standards	UL, cUL ²⁾ , CE, RCM, SEMI F47	
CE marking	According to Low Voltage Directive 2014/35/EU, EMC Directive 2014/30/EU	

¹⁾ Applies to industrial control panel installations acc. to NEC Article 409 or UL 508A/508C.

²⁾ Applies to PM230 Power Modules, frame sizes FSA to FSC.

SINAMICS G120P built-in and wall-mounted units

PM230 Power Modules, 0.37 kW to 90 kW

PM230 Power Modules

Technical specifications (continued)

PM230 Power Modules, degree of protection IP55

Line voltage 380 ... 480 V 3 AC		PM230 Power Modules, degree of protection IP55/UL Type 12				
With integrated line filter class A		6SL3223-ODE13-7AG1	6SL3223-ODE15-5AG1	6SL3223-ODE17-5AG1	6SL3223-ODE21-1AG1	6SL3223-ODE21-5AG1
With integrated line filter class B		6SL3223-ODE13-7BG1	6SL3223-ODE15-5BG1	6SL3223-ODE17-5BG1	6SL3223-ODE21-1BG1	6SL3223-ODE21-5BG1
Output current at 50 Hz 400 V 3 AC						
• Rated current $I_{rated}^{1)}$	A	1.3	1.7	2.2	3.1	4.1
• Base-load current $I_L^{1)}$	A	1.3	1.7	2.2	3.1	4.1
• Base-load current $I_H^{2)}$	A	0.9	1.3	1.7	2.2	3.1
• Maximum current I_{max}	A	2	2.6	3.4	4.7	6.2
Rated power						
• Based on I_L	kW	0.37	0.55	0.75	1.1	1.5
• Based on I_H	kW	0.25	0.37	0.55	0.75	1.1
Rated pulse frequency	kHz	4	4	4	4	4
Efficiency η	%	86	90	92	94	95
Power loss ³⁾ at rated current	kW	0.04	0.043	0.047	0.055	0.064
Cooling air requirement	m ³ /s (ft ³ /s)	0.007 (0.25)	0.007 (0.25)	0.007 (0.25)	0.007 (0.25)	0.007 (0.25)
Sound pressure level L_{pA} (1 m)	dB	61.9	61.9	61.9	61.9	61.9
24 V DC power supply for Control Unit	A	1	1	1	1	1
Input current ⁴⁾						
• Rated current	A	1.3	1.8	2.3	3.2	4.2
• Based on I_H	A	0.9	1.3	1.8	2.3	3.2
Line supply connection U1/L1, V1/L2, W1/L3						
• Conductor cross-section	mm ²	Screw-type terminals, plug-in 1 ... 2.5	Screw-type terminals, plug-in 1 ... 2.5	Screw-type terminals, plug-in 1 ... 2.5	Screw-type terminals, plug-in 1 ... 2.5	Screw-type terminals, plug-in 1 ... 2.5
Motor connection U2, V2, W2						
• Conductor cross-section	mm ²	Screw-type terminals, plug-in 1 ... 2.5	Screw-type terminals, plug-in 1 ... 2.5	Screw-type terminals, plug-in 1 ... 2.5	Screw-type terminals, plug-in 1 ... 2.5	Screw-type terminals, plug-in 1 ... 2.5
Motor cable length, max. ⁵⁾						
• Shielded	m (ft)	25 (82)	25 (82)	25 (82)	25 (82)	25 (82)
• Unshielded	m (ft)	100 (328)	100 (328)	100 (328)	100 (328)	100 (328)
Degree of protection ⁶⁾						
		IP55/UL Type 12	IP55/UL Type 12	IP55/UL Type 12	IP55/UL Type 12	IP55/UL Type 12
Dimensions						
• Width	mm (in)	154 (6.06)	154 (6.06)	154 (6.06)	154 (6.06)	154 (6.06)
• Height	mm (in)	460 (18.11)	460 (18.11)	460 (18.1)	460 (18.11)	460 (18.1)
• Depth						
- Without operator panel	mm (in)	249 (9.80)	249 (9.80)	249 (9.80)	249 (9.80)	249 (9.80)
- With operator panel, max.	mm (in)	266 (10.47)	266 (10.47)	266 (10.47)	266 (10.47)	266 (10.47)
Frame size						
		FSA	FSA	FSA	FSA	FSA
Weight, approx.						
		kg (lb)	4.3 (9.48)	4.3 (9.48)	4.3 (9.48)	4.3 (9.48)

¹⁾ The rated output current I_{rated} and the base-load current I_L are based on the duty cycle for low overload (LO).

²⁾ The base-load current I_H is based on the duty cycle for high overload (HO).

³⁾ Typical values. You can find more information on the Internet at <https://support.industry.siemens.com/cs/document/94059311>

⁴⁾ The input current depends on the motor load and line impedance and applies for a line impedance corresponding to $u_K = 1\%$. The rated input currents apply for a load at rated power (based on I_{rated}) – these current values are specified on the rating plate.

⁵⁾ Max. motor cable length 25 m (82 ft) (shielded) for PM230 Power Modules with integrated line filter to maintain the limit values of EN 61800-3 Category C2 (filter A) or C1 table 14 (filter B). With unshielded cables, Categories C2 and C1 are not achieved.

⁶⁾ It is essential to plug on an operator panel or the blanking cover in order to achieve degree of protection IP55/UL Type 12. For more information, see Operator panels and blanking cover for PM230 Power Modules in section Supplementary system components.

SINAMICS G120P built-in and wall-mounted units

PM230 Power Modules, 0.37 kW to 90 kW

PM230 Power Modules

Technical specifications (continued)

Line voltage 380 ... 480 V 3 AC		PM230 Power Modules, degree of protection IP55/UL Type 12					
With integrated line filter class A		6SL3223-0DE22-2AG1	6SL3223-0DE23-0AG1	6SL3223-0DE24-0AG1	6SL3223-0DE25-5AG1	6SL3223-0DE27-5AG1	
With integrated line filter class B		6SL3223-0DE22-2BG1	6SL3223-0DE23-0BG1	6SL3223-0DE24-0BG1	6SL3223-0DE25-5BG1	6SL3223-0DE27-5BG1	
Output current at 50 Hz 400 V 3 AC							
• Rated current $I_{rated}^{1)}$	A	5.9	7.7	10.2	13.2	18	
• Base-load current $I_L^{1)}$	A	5.9	7.7	10.2	13.2	18	
• Base-load current $I_H^{2)}$	A	4.1	5.9	7.7	10.2	13.2	
• Maximum current I_{max}	A	8.9	11.8	15.4	20.4	27	
Rated power							
• Based on I_L	kW	2.2	3	4	5.5	7.5	
• Based on I_H	kW	1.5	2.2	3	4	5.5	
Rated pulse frequency	kHz	4	4	4	4	4	
Efficiency η	%	96	96	97	97	97	
Power loss ³⁾ at rated current	kW	0.086	0.11	0.137	0.173	0.235	
Cooling air requirement	m ³ /s (ft ³ /s)	0.007 (0.25)	0.007 (0.25)	0.009 (0.32)	0.009 (0.32)	0.009 (0.32)	
Sound pressure level L_{pA} (1 m)	dB	61.9	61.9	62.8	62.8	62.8	
24 V DC power supply for Control Unit	A	1	1	1	1	1	
Input current ⁴⁾							
• Rated current	A	6.1	8	11	14	19	
• Based on I_H	A	4.2	6.1	8	11	14	
Line supply connection U1/L1, V1/L2, W1/L3		Screw-type terminals, plug-in	Screw-type terminals, plug-in	Screw-type terminals, plug-in	Screw-type terminals, plug-in	Screw-type terminals, plug-in	
• Conductor cross-section	mm ²	1 ... 2.5	1 ... 2.5	2.5 ... 6	2.5 ... 6	2.5 ... 6	
Motor connection U2, V2, W2		Screw-type terminals, plug-in	Screw-type terminals, plug-in	Screw-type terminals, plug-in	Screw-type terminals, plug-in	Screw-type terminals, plug-in	
• Conductor cross-section	mm ²	1 ... 2.5	1 ... 2.5	2.5 ... 6	2.5 ... 6	2.5 ... 6	
Motor cable length, max. ⁵⁾							
• Shielded	m (ft)	25 (82)	25 (82)	25 (82)	25 (82)	25 (82)	
• Unshielded	m (ft)	100 (328)	100 (328)	100 (328)	100 (328)	100 (328)	
Degree of protection ⁶⁾		IP55/UL Type 12	IP55/UL Type 12	IP55/UL Type 12	IP55/UL Type 12	IP55/UL Type 12	
Dimensions							
• Width	mm (in)	154 (6.06)	154 (6.06)	180 (7.09)	180 (7.09)	180 (7.09)	
• Height	mm (in)	460 (18.11)	460 (18.11)	540 (21.26)	540 (21.26)	540 (21.26)	
• Depth							
- Without operator panel	mm (in)	249 (9.80)	249 (9.80)	249 (9.80)	249 (9.80)	249 (9.80)	
- With operator panel, max.	mm (in)	266 (10.47)	266 (10.47)	266 (10.47)	266 (10.47)	266 (10.47)	
Frame size		FSA	FSA	FSB	FSB	FSB	
Weight, approx.	kg (lb)	4.3 (9.48)	4.3 (9.48)	6.3 (14)	6.3 (14)	6.3 (14)	

¹⁾ The rated output current I_{rated} and the base-load current I_L are based on the duty cycle for low overload (LO).

²⁾ The base-load current I_H is based on the duty cycle for high overload (HO).

³⁾ Typical values. You can find more information on the Internet at <https://support.industry.siemens.com/cs/document/94059311>

⁴⁾ The input current depends on the motor load and line impedance and applies for a line impedance corresponding to $u_K = 1\%$. The rated input currents apply for a load at rated power (based on I_{rated}) – these current values are specified on the rating plate.

⁵⁾ Max. motor cable length 25 m (82 ft) (shielded) for PM230 Power Modules with integrated line filter to maintain the limit values of EN 61800-3 Category C2 (filter A) or C1 table 14 (filter B). With unshielded cables, Categories C2 and C1 are not achieved.

⁶⁾ It is essential to plug on an operator panel or the blanking cover in order to achieve degree of protection IP55/UL Type 12.
For more information, see Operator panels and blanking cover for PM230 Power Modules in section Supplementary system components.

SINAMICS G120P built-in and wall-mounted units

PM230 Power Modules, 0.37 kW to 90 kW

PM230 Power Modules

Technical specifications (continued)

Line voltage 380 ... 480 V 3 AC		PM230 Power Modules, degree of protection IP55/UL Type 12					
With integrated line filter class A		6SL3223-0DE31-1AG1	6SL3223-0DE31-5AG1	6SL3223-0DE31-8AG1	–	6SL3223-0DE32-2AA0	6SL3223-0DE33-0AA0
With integrated line filter class B		6SL3223-0DE31-1BG1	6SL3223-0DE31-5BG1	–	6SL3223-0DE31-8BA0	6SL3223-0DE32-2BA0	6SL3223-0DE33-0BA0
Output current at 50 Hz 400 V 3 AC							
• Rated current $I_{rated}^{1)}$	A	26	32	38	38	45	60
• Base-load current $I_L^{1)}$	A	26	32	38	38	45	60
• Base-load current $I_H^{2)}$	A	18	26	32	32	38	45
• Maximum current I_{max}	A	39	52	64	48	57	67
Rated power							
• Based on I_L	kW	11	15	18.5	18.5	22	30
• Based on I_H	kW	7.5	11	15	15	18.5	22
Rated pulse frequency	kHz	4	4	4	4	4	4
Efficiency η	%	97	97	98	97	97	97
Power loss ³⁾ at rated current	kW	0.299	0.365	0.435	0.478	0.569	0.784
Cooling air requirement	m ³ /s (ft ³ /s)	0.02 (0.7)	0.02 (0.7)	0.02 (0.7)	0.039 (1.4)	0.039 (1.4)	0.039 (1.4)
Sound pressure level L_{pA} (1 m)	dB	66.1	66.1	66.1	56	56	56
24 V DC power supply for Control Unit	A	1	1	1	1	1	1
Input current ⁴⁾							
• Rated current	A	27	33	39	39	42	56
• Based on I_H	A	19	27	33	33	36	42
Line supply connection U1/L1, V1/L2, W1/L3		Screw-type terminals, plug-in	Screw-type terminals, plug-in	Screw-type terminals, plug-in	M6 screw studs	M6 screw studs	M6 screw studs
• Conductor cross-section	mm ²	6 ... 16	6 ... 16	6 ... 16	10 ... 35	10 ... 35	10 ... 35
Motor connection U2, V2, W2		Screw-type terminals, plug-in	Screw-type terminals, plug-in	Screw-type terminals, plug-in	M6 screw studs	M6 screw studs	M6 screw studs
• Conductor cross-section	mm ²	6 ... 16	6 ... 16	6 ... 16	10 ... 35	10 ... 35	10 ... 35
Motor cable length, max. ⁵⁾							
• Shielded	m (ft)	25 (82)	25 (82)	25 (82)	25 (82)	25 (82)	25 (82)
• Unshielded	m (ft)	100 (328)	100 (328)	100 (328)	100 (328)	100 (328)	100 (328)
Degree of protection ⁶⁾		IP55/UL Type 12	IP55/UL Type 12	IP55/UL Type 12	IP55/UL Type 12	IP55/UL Type 12	IP55/UL Type 12
Dimensions							
• Width	mm (in)	230 (9.06)	230 (9.06)	230 (9.06)	320 (12.60)	320 (12.60)	320 (12.60)
• Height	mm (in)	620 (24.41)	620 (24.41)	620 (24.41)	640 (25.20)	640 (25.20)	640 (25.20)
• Depth							
- Without operator panel	mm (in)	249 (9.80)	249 (9.80)	249 (9.80)	329 (12.95)	329 (12.95)	329 (12.95)
- With operator panel, max.	mm (in)	266 (10.47)	266 (10.47)	266 (10.47)	346 (13.62)	346 (13.62)	346 (13.62)
Frame size		FSC	FSC	FSC	FSD	FSD	FSD
Weight, approx.	kg (lb)	9.5 (20.95)	9.5 (20.95)	9.5 (20.95)	31 (68.36)	31 (68.36)	31 (68.36)

¹⁾ The rated output current I_{rated} and the base-load current I_L are based on the duty cycle for low overload (LO).

²⁾ The base-load current I_H is based on the duty cycle for high overload (HO).

³⁾ Typical values. You can find more information on the Internet at <https://support.industry.siemens.com/cs/document/94059311>

⁴⁾ The input current depends on the motor load and line impedance and applies for a line impedance corresponding to $u_K = 1\%$. The rated input currents apply for a load at rated power (based on I_{rated}) – these current values are specified on the rating plate.

⁵⁾ Max. motor cable length 25 m (82 ft) (shielded) for PM230 Power Modules with integrated line filter to maintain the limit values of EN 61800-3 Category C2 (filter A) or C1 table 14 (filter B). With unshielded cables, Categories C2 and C1 are not achieved.

⁶⁾ It is essential to plug on an operator panel or the blanking cover in order to achieve degree of protection IP55/UL Type 12.
For more information, see [Operator panels and blanking cover for PM230 Power Modules](#) in section Supplementary system components.

SINAMICS G120P built-in and wall-mounted units

PM230 Power Modules, 0.37 kW to 90 kW

PM230 Power Modules

Technical specifications (continued)

Line voltage 380 ... 480 V 3 AC		PM230 Power Modules, degree of protection IP55/UL Type 12				
With integrated line filter class A		6SL3223-0DE33-7AA0	6SL3223-0DE34-5AA0	6SL3223-0DE35-5AA0	6SL3223-0DE37-5AA0	6SL3223-0DE38-8AA0
With integrated line filter class B		6SL3223-0DE33-7BA0	6SL3223-0DE34-5BA0	6SL3223-0DE35-5BA0	6SL3223-0DE37-5BA0	6SL3223-0DE38-8BA0
Output current at 50 Hz 400 V 3 AC						
• Rated current $I_{rated}^{1)}$	A	75	90	110	145	178
• Base-load current $I_L^{1)}$	A	75	90	110	145	178
• Base-load current $I_H^{2)}$	A	60	75	90	110	145
• Maximum current I_{max}	A	90	112	135	165	217
Rated power						
• Based on I_L	kW	37	45	55	75	90
• Based on I_H	kW	30	37	45	55	75
Rated pulse frequency						
	kHz	4	4	4	4	4
Efficiency η						
	%	97	97	97	97	97
Power loss ³⁾ at rated current						
	kW	0.855	1.073	1.122	1.542	1.98
Cooling air requirement						
	m ³ /s (ft ³ /s)	0.039 (1.4)	0.039 (1.4)	0.117 (4.1)	0.117 (4.1)	0.117 (4.1)
Sound pressure level L_{pA} (1 m)						
	dB	56	56	61	61	61
24 V DC power supply for Control Unit						
	A	1	1	1	1	1
Input current ⁴⁾						
• Rated current	A	70	84	102	135	166
• Based on I_H	A	56	70	84	102	135
Line supply connection U1/L1, V1/L2, W1/L3						
• Conductor cross-section	mm ²	25 ... 50	25 ... 50	35 ... 120	35 ... 120	35 ... 120
Motor connection U2, V2, W2						
• Conductor cross-section	mm ²	25 ... 50	25 ... 50	35 ... 120	35 ... 120	35 ... 120
Motor cable length, max. ⁵⁾						
• Shielded	m (ft)	25 (82)	25 (82)	25 (82)	25 (82)	25 (82)
• Unshielded	m (ft)	100 (328)	100 (328)	100 (328)	100 (328)	100 (328)
Degree of protection ⁶⁾						
		IP55/UL Type 12	IP55/UL Type 12	IP55/UL Type 12	IP55/UL Type 12	IP55/UL Type 12
Dimensions						
• Width	mm (in)	320 (12.60)	320 (12.60)	410 (16.14)	410 (16.14)	410 (16.14)
• Height	mm (in)	751 (29.57)	751 (29.57)	915 (36.02)	915 (36.02)	915 (36.02)
• Depth						
- Without operator panel	mm (in)	329 (12.95)	329 (12.95)	416 (16.38)	416 (16.38)	416 (16.38)
- With operator panel, max.	mm (in)	346 (13.62)	346 (13.62)	433 (17.05)	433 (17.05)	433 (17.05)
Frame size						
		FSE	FSE	FSF	FSF	FSF
Weight, approx.						
	kg (lb)	37 (81.59) (with filter cl. A) 38 (83.79) (with filter cl. B)	37 (81.59) (with filter cl. A) 38 (83.79) (with filter cl. B)	70 (154.35)	70 (154.35)	70 (154.35)

¹⁾ The rated output current I_{rated} and the base-load current I_L are based on the duty cycle for low overload (LO).

²⁾ The base-load current I_H is based on the duty cycle for high overload (HO).

³⁾ Typical values. You can find more information on the Internet at <https://support.industry.siemens.com/cs/document/94059311>

⁴⁾ The input current depends on the motor load and line impedance and applies for a line impedance corresponding to $u_K = 1\%$. The rated input currents apply for a load at rated power (based on I_{rated}) – these current values are specified on the rating plate.

⁵⁾ Max. motor cable length 25 m (82 ft) (shielded) for PM230 Power Modules with integrated line filter to maintain the limit values of EN 61800-3 Category C2 (filter A) or C1 table 14 (filter B). With unshielded cables, Categories C2 and C1 are not achieved.

⁶⁾ It is essential to plug on an operator panel or the blanking cover in order to achieve degree of protection IP55/UL Type 12.
For more information, see [Operator panels and blanking cover for PM230 Power Modules](#) in section Supplementary system components.

SINAMICS G120P built-in and wall-mounted units

PM230 Power Modules, 0.37 kW to 90 kW

PM230 Power Modules

Technical specifications (continued)

PM230 Power Modules degree of protection IP20 standard variant

Line voltage 380 ... 480 V 3 AC		PM230 Power Modules degree of protection IP20 standard variant				
Without integrated line filter		6SL3210-1NE11-3UG1	6SL3210-1NE11-7UG1	6SL3210-1NE12-2UG1	6SL3210-1NE13-1UG1	6SL3210-1NE14-1UG1
With integrated line filter class A		6SL3210-1NE11-3AG1	6SL3210-1NE11-7AG1	6SL3210-1NE12-2AG1	6SL3210-1NE13-1AG1	6SL3210-1NE14-1AG1
Output current at 50 Hz 400 V 3 AC						
• Rated current $I_{rated}^{1)}$	A	1.3	1.7	2.2	3.1	4.1
• Base-load current $I_L^{1)}$	A	1.3	1.7	2.2	3.1	4.1
• Base-load current $I_H^{2)}$	A	0.9	1.3	1.7	2.2	3.1
• Maximum current I_{max}	A	2	2.6	3.4	4.7	6.2
Rated power						
• Based on I_L	kW	0.37	0.55	0.75	1.1	1.5
• Based on I_H	kW	0.25	0.37	0.55	0.75	1.1
Rated pulse frequency	kHz	4	4	4	4	4
Efficiency η	%	89	93	93	94	95
Power loss ³⁾ at rated current	kW	0.031	0.034	0.041	0.049	0.06
Cooling air requirement	m ³ /s (ft ³ /s)	0.002 (0.1)	0.002 (0.1)	0.005 (0.2)	0.005 (0.2)	0.005 (0.2)
Sound pressure level L_{pA} (1 m)	dB	<50	<50	<50	<50	<50
24 V DC power supply for Control Unit	A	1	1	1	1	1
Input current ⁴⁾						
• Rated current	A	1.3	1.8	2.3	3.2	4.2
• Based on I_H	A	0.9	1.3	1.8	2.3	3.2
Line supply connection U1/L1, V1/L2, W1/L3						
• Conductor cross-section	mm ²	1 ... 2.5	1 ... 2.5	1 ... 2.5	1 ... 2.5	1 ... 2.5
Motor connection U2, V2, W2						
• Conductor cross-section	mm ²	1 ... 2.5	1 ... 2.5	1 ... 2.5	1 ... 2.5	1 ... 2.5
Motor cable length, max. ⁵⁾						
• Shielded	m (ft)	25 (82)	25 (82)	25 (82)	25 (82)	25 (82)
• Unshielded	m (ft)	100 (328)	100 (328)	100 (328)	100 (328)	100 (328)
Degree of protection						
		IP20	IP20	IP20	IP20	IP20
Dimensions						
• Width	mm (in)	73 (2.87)	73 (2.87)	73 (2.87)	73 (2.87)	73 (2.87)
• Height	mm (in)	196 (7.72)	196 (7.72)	196 (7.72)	196 (7.72)	196 (7.72)
• Depth						
- Without operator panel	mm (in)	165 (6.50)	165 (6.50)	165 (6.50)	165 (6.50)	165 (6.50)
- With operator panel, max.	mm (in)	245 (9.65)	245 (9.65)	245 (9.65)	245 (9.65)	245 (9.65)
Frame size						
		FSA	FSA	FSA	FSA	FSA
Weight, approx.						
• Without integrated line filter	kg (lb)	1.4 (3.09)	1.4 (3.09)	1.4 (3.09)	1.4 (3.09)	1.4 (3.09)
• With integrated line filter	kg (lb)	1.6 (3.53)	1.6 (3.53)	1.6 (3.53)	1.6 (3.53)	1.6 (3.53)

¹⁾ The rated output current I_{rated} and the base-load current I_L are based on the duty cycle for low overload (LO).

²⁾ The base-load current I_H is based on the duty cycle for high overload (HO).

³⁾ Typical values. You can find more information on the Internet at <https://support.industry.siemens.com/cs/document/94059311>

⁴⁾ The input current depends on the motor load and line impedance and applies for a line impedance corresponding to $u_K = 1\%$. The rated input currents apply for a load at rated power (based on I_{rated}) – these current values are specified on the rating plate.

⁵⁾ Max. motor cable length 25 m (82 ft) (shielded) for PM230 Power Modules with integrated line filter to maintain the limit values acc. to EN 61800-3 Category C2. With unshielded cables, Category C2 is not achieved.

SINAMICS G120P built-in and wall-mounted units

PM230 Power Modules, 0.37 kW to 90 kW

PM230 Power Modules

Technical specifications (continued)

Line voltage 380 ... 480 V 3 AC		PM230 Power Modules degree of protection IP20 standard variant				
Without integrated line filter		6SL3210-1NE15-8UG1	6SL3210-1NE17-7UG1	6SL3210-1NE21-0UG1	6SL3210-1NE21-3UG1	6SL3210-1NE21-8UG1
With integrated line filter class A		6SL3210-1NE15-8AG1	6SL3210-1NE17-7AG1	6SL3210-1NE21-0AG1	6SL3210-1NE21-3AG1	6SL3210-1NE21-8AG1
Output current at 50 Hz 400 V 3 AC						
• Rated current $I_{rated}^{1)}$	A	5.9	7.7	10.2	13.2	18
• Base-load current $I_L^{1)}$	A	5.9	7.7	10.2	13.2	18
• Base-load current $I_H^{2)}$	A	4.1	5.9	7.7	10.2	13.2
• Maximum current I_{max}	A	8.9	11.8	15.4	20.4	27
Rated power						
• Based on I_L	kW	2.2	3	4	5.5	7.5
• Based on I_H	kW	1.5	2.2	3	4	5.5
Rated pulse frequency	kHz	4	4	4	4	4
Efficiency η	%	96	96	97	97	97
Power loss ³⁾ at rated current	kW	0.078	0.102	0.13	0.165	0.224
Cooling air requirement	m ³ /s (ft ³ /s)	0.005 (0.2)	0.005 (0.2)	0.009 (0.3)	0.009 (0.3)	0.009 (0.3)
Sound pressure level L_{pA} (1 m)	dB	<50	<50	<62	<62	<62
24 V DC power supply for Control Unit	A	1	1	1	1	1
Input current ⁴⁾						
• Rated current	A	6.1	8	11	14	19
• Based on I_H	A	4.2	6.1	8	11	14
Line supply connection U1/L1, V1/L2, W1/L3						
• Conductor cross-section	mm ²	Screw-type terminals, plug-in 1.5 ... 2.5	Screw-type terminals, plug-in 1.5 ... 2.5	Screw-type terminals, plug-in 1.5 ... 6	Screw-type terminals, plug-in 1.5 ... 6	Screw-type terminals, plug-in 1.5 ... 6
Motor connection U2, V2, W2						
• Conductor cross-section	mm ²	Screw-type terminals, plug-in 1.5 ... 2.5	Screw-type terminals, plug-in 1.5 ... 2.5	Screw-type terminals, plug-in 1.5 ... 6	Screw-type terminals, plug-in 1.5 ... 6	Screw-type terminals, plug-in 1.5 ... 6
Motor cable length, max. ⁵⁾						
• Shielded	m (ft)	25 (82)	25 (82)	25 (82)	25 (82)	25 (82)
• Unshielded	m (ft)	100 (328)	100 (328)	100 (328)	100 (328)	100 (328)
Degree of protection		IP20	IP20	IP20	IP20	IP20
Dimensions						
• Width	mm (in)	73 (2.87)	73 (2.87)	100 (328.10)	100 (328.10)	100 (328.10)
• Height	mm (in)	196 (7.72)	196 (7.72)	292 (11.50)	292 (11.50)	292 (11.50)
• Depth						
- Without operator panel	mm (in)	165 (6.50)	165 (6.50)	165 (6.50)	165 (6.50)	165 (6.50)
- With operator panel, max.	mm (in)	245 (9.65)	245 (9.65)	245 (9.65)	245 (9.65)	245 (9.65)
Frame size		FSA	FSA	FSB	FSB	FSB
Weight, approx.						
• Without integrated line filter	kg (lb)	1.4 (3.09)	1.4 (3.09)	2.8 (6.17)	2.8 (6.17)	2.8 (6.17)
• With integrated line filter	kg (lb)	1.6 (3.53)	1.6 (3.53)	3 (6.61)	3 (6.61)	3 (6.61)

¹⁾ The rated output current I_{rated} and the base-load current I_L are based on the duty cycle for low overload (LO).

²⁾ The base-load current I_H is based on the duty cycle for high overload (HO).

³⁾ Typical values. You can find more information on the Internet at <https://support.industry.siemens.com/cs/document/94059311>

⁴⁾ The input current depends on the motor load and line impedance and applies for a line impedance corresponding to $u_K = 1\%$. The rated input currents apply for a load at rated power (based on I_{rated}) – these current values are specified on the rating plate.

⁵⁾ Max. motor cable length 25 m (82 ft) (shielded) for PM230 Power Modules with integrated line filter to maintain the limit values acc. to EN 61800-3 Category C2. With unshielded cables, Category C2 is not achieved.

SINAMICS G120P built-in and wall-mounted units

PM230 Power Modules, 0.37 kW to 90 kW

PM230 Power Modules

Technical specifications (continued)

Line voltage 380 ... 480 V 3 AC		PM230 Power Modules degree of protection IP20 standard variant				
Without integrated line filter		6SL3210-1NE22-6UG1	6SL3210-1NE23-2UG1	6SL3210-1NE23-8UG1	6SL3210-1NE24-5ULO	6SL3210-1NE26-0ULO
With integrated line filter class A		6SL3210-1NE22-6AG1	6SL3210-1NE23-2AG1	6SL3210-1NE23-8AG1	6SL3210-1NE24-5ALO	6SL3210-1NE26-0ALO
Output current at 50 Hz 400 V 3 AC						
• Rated current $I_{rated}^{1)}$	A	26	32	38	45	60
• Base-load current $I_L^{1)}$	A	26	32	38	45	60
• Base-load current $I_H^{2)}$	A	18	26	32	38	45
• Maximum current I_{max}	A	39	52	64	57	67
Rated power						
• Based on I_L	kW	11	15	18.5	22	30
• Based on I_H	kW	7.5	11	15	18.5	22
Rated pulse frequency						
	kHz	4	4	4	4	4
Efficiency η						
	%	97	97	98	98	97
Power loss ³⁾ at rated current						
	kW	0.291	0.355	0.423	0.539	0.726
Cooling air requirement						
	m ³ /s (ft ³ /s)	0.019 (0.7)	0.019 (0.7)	0.019 (0.7)	0.08 (2.8)	0.08 (2.8)
Sound pressure level L_{pA} (1 m)						
	dB	<65	<65	<65	<60	<60
24 V DC power supply for Control Unit						
	A	1	1	1	1	1
Input current ⁴⁾						
• Rated current	A	27	33	39	42	56
• Based on I_H	A	19	27	33	36	42
Line supply connection U1/L1, V1/L2, W1/L3						
• Conductor cross-section	mm ²	Screw-type terminals, plug-in 6 ... 16	Screw-type terminals, plug-in 6 ... 16	Screw-type terminals, plug-in 6 ... 16	M6 screw studs 16 ... 35	M6 screw studs 16 ... 35
Motor connection U2, V2, W2						
• Conductor cross-section	mm ²	Screw-type terminals, plug-in 6 ... 16	Screw-type terminals, plug-in 6 ... 16	Screw-type terminals, plug-in 6 ... 16	M6 screw studs 16 ... 35	M6 screw studs 16 ... 35
Motor cable length, max. ⁵⁾						
• Shielded	m (ft)	25 (82)	25 (82)	25 (82)	25 (82)	25 (82)
• Unshielded	m (ft)	100 (328)	100 (328)	100 (328)	100 (328)	100 (328)
Degree of protection						
		IP20	IP20	IP20	IP20	IP20
Dimensions						
• Width	mm (in)	140 (5.51)	140 (5.51)	140 (5.51)	275 (10.83)	275 (10.83)
• Height						
- Without integrated line filter	mm (in)	355 (13.98)	355 (13.98)	355 (13.98)	419 (16.50)	419 (16.50)
- With integrated line filter	mm (in)	355 (13.98)	355 (13.98)	355 (13.98)	512 (20.16)	512 (20.16)
• Depth						
- Without operator panel	mm (in)	165 (6.50)	165 (6.50)	165 (6.50)	204 (8.03)	204 (8.03)
- With operator panel, max.	mm (in)	245 (9.65)	245 (9.65)	245 (9.65)	275 (10.83)	275 (10.83)
Frame size						
		FSC	FSC	FSC	FSD	FSD
Weight, approx.						
• Without integrated line filter	kg (lb)	4.5 (9.92)	4.5 (9.92)	4.5 (9.92)	11 (24.3)	11 (24.3)
• With integrated line filter	kg (lb)	5.1 (11.25)	5.1 (11.25)	5.1 (11.25)	14 (30.87)	14 (30.87)

¹⁾ The rated output current I_{rated} and the base-load current I_L are based on the duty cycle for low overload (LO).

²⁾ The base-load current I_H is based on the duty cycle for high overload (HO).

³⁾ Typical values. You can find more information on the Internet at <https://support.industry.siemens.com/cs/document/94059311>

⁴⁾ The input current depends on the motor load and line impedance and applies for a line impedance corresponding to $u_k = 1\%$. The rated input currents apply for a load at rated power (based on I_{rated}) – these current values are specified on the rating plate.

⁵⁾ Max. motor cable length 25 m (82 ft) (shielded) for PM230 Power Modules with integrated line filter to maintain the limit values acc. to EN 61800-3 Category C2. With unshielded cables, Category C2 is not achieved.

SINAMICS G120P built-in and wall-mounted units

PM230 Power Modules, 0.37 kW to 90 kW

PM230 Power Modules

Technical specifications (continued)

Line voltage 380 ... 480 V 3 AC		PM230 Power Modules degree of protection IP20 standard variant			
Without integrated line filter		6SL3210-1NE27-5ULO	6SL3210-1NE28-8ULO	6SL3210-1NE31-1ULO	6SL3210-1NE31-5ULO
With integrated line filter class A		6SL3210-1NE27-5ALO	6SL3210-1NE28-8ALO	6SL3210-1NE31-1ALO	6SL3210-1NE31-5ALO
Output current at 50 Hz 400 V 3 AC					
• Rated current $I_{rated}^{1)}$	A	75	90	110	145
• Base-load current $I_L^{1)}$	A	75	90	110	145
• Base-load current $I_H^{2)}$	A	60	75	90	110
• Maximum current I_{max}	A	90	112	135	165
Rated power					
• Based on I_L	kW	37	45	55	75
• Based on I_H	kW	30	37	45	55
Rated pulse frequency					
	kHz	4	4	4	4
Efficiency η					
	%	97	97	97	97
Power loss ³⁾ at rated current					
	kW	0.791	0.976	1.237	1.69
Cooling air requirement					
	m ³ /s (ft ³ /s)	0.08 (2.8)	0.08 (2.8)	0.15 (5.3)	0.15 (5.3)
Sound pressure level L_{pA} (1 m)					
	dB	<60	<60	<60	<60
24 V DC power supply for Control Unit					
	A	1	1	1	1
Input current ⁴⁾					
• Rated current	A	70	84	102	135
• Based on I_H	A	56	70	84	102
Line supply connection U1/L1, V1/L2, W1/L3					
• Conductor cross-section	mm ²	25 ... 50	25 ... 50	35 ... 120	35 ... 120
Motor connection U2, V2, W2					
• Conductor cross-section	mm ²	25 ... 50	25 ... 50	35 ... 120	35 ... 120
Motor cable length, max. ⁵⁾					
• Shielded	m (ft)	25 (82)	25 (82)	25 (82)	25 (82)
• Unshielded	m (ft)	100 (328)	100 (328)	100 (328)	100 (328)
Degree of protection					
		IP20	IP20	IP20	IP20
Dimensions					
• Width	mm (in)	275 (10.83)	275 (10.83)	350 (13.78)	350 (13.78)
• Height					
- Without integrated line filter	mm (in)	499 (19.65)	499 (19.65)	634 (24.96)	634 (24.96)
- With integrated line filter	mm (in)	635 (25)	635 (25)	934 (36.77)	934 (36.77)
• Depth					
- Without operator panel	mm (in)	204 (8.03)	204 (8.03)	316 (12.44)	316 (12.44)
- With operator panel, max.	mm (in)	275 (10.83)	275 (10.83)	387 (15.24)	387 (15.24)
Frame size					
		FSE	FSE	FSF	FSF
Weight, approx.					
• Without integrated line filter	kg (lb)	15 (33.1)	15 (33.1)	34 (74.97)	34 (74.97)
• With integrated line filter	kg (lb)	22 (48.5)	22 (48.5)	46 (101.43)	46 (101.43)

¹⁾ The rated output current I_{rated} and the base-load current I_L are based on the duty cycle for low overload (LO).

²⁾ The base-load current I_H is based on the duty cycle for high overload (HO).

³⁾ Typical values. You can find more information on the Internet at <https://support.industry.siemens.com/cs/document/94059311>

⁴⁾ The input current depends on the motor load and line impedance and applies for a line impedance corresponding to $u_K = 1\%$. The rated input currents apply for a load at rated power (based on I_{rated}) – these current values are specified on the rating plate.

⁵⁾ Max. motor cable length 25 m (82 ft) (shielded) for PM230 Power Modules with integrated line filter to maintain the limit values acc. to EN 61800-3 Category C2. With unshielded cables, Category C2 is not achieved.

SINAMICS G120P built-in and wall-mounted units

PM230 Power Modules, 0.37 kW to 90 kW

PM230 Power Modules

Technical specifications (continued)

PM230 Power Modules degree of protection IP20 Push Through variant

Line voltage 380 ... 480 V 3 AC		PM230 Power Modules degree of protection IP20 Push Through variant		
Without integrated line filter		6SL3211-1NE17-7UG1	6SL3211-1NE21-8UG1	6SL3211-1NE23-8UG1
With integrated line filter class A		6SL3211-1NE17-7AG1	6SL3211-1NE21-8AG1	6SL3211-1NE23-8AG1
Output current at 50 Hz 400 V 3 AC				
• Rated current $I_{rated}^{1)}$	A	7.7	18	38
• Base-load current $I_L^{1)}$	A	7.7	18	38
• Base-load current $I_H^{2)}$	A	5.9	13.2	32
• Maximum current I_{max}	A	11.8	27	64
Rated power				
• Based on I_L	kW	3	7.5	18.5
• Based on I_H	kW	2.2	5.5	15
Rated pulse frequency				
	kHz	4	4	4
Efficiency η				
	%	96	97	98
Power loss ³⁾ at rated current				
	kW	0.102	0.224	0.423
Cooling air requirement				
	m ³ /s (ft ³ /s)	0.005 (0.2)	0.009 (0.3)	0.019 (0.7)
Sound pressure level L_{pA} (1 m)				
	dB	<56	<62	<65
24 V DC power supply for Control Unit				
	A	1	1	1
Input current ⁴⁾				
• Rated current	A	8	19	39
• Based on I_H	A	6.1	14	33
Line supply connection U1/L1, V1/L2, W1/L3				
• Conductor cross-section	mm ²	1.5 ... 2.5	4 ... 6	6 ... 16
Motor connection U2, V2, W2				
• Conductor cross-section	mm ²	1 ... 2.5	4 ... 6	10 ... 16
Motor cable length, max. ⁵⁾				
• Shielded	m (ft)	25 (82)	25 (82)	25 (82)
• Unshielded	m (ft)	100 (328)	100 (328)	100 (328)
Degree of protection				
		IP20	IP20	IP20
Dimensions				
• Width	mm (in)	126 (4.96)	154 (6.06)	200 (7.87)
• Height	mm (in)	238 (9.37)	345 (13.58)	411 (16.18)
• Depth				
- Without operator panel	mm (in)	171 (6.73)	171 (6.73)	171 (6.73)
- With operator panel, max.	mm (in)	251 (9.88)	251 (9.88)	251 (9.88)
Frame size				
		FSA	FSB	FSC
Weight, approx. With integrated line filter				
• Without integrated line filter	kg (lb)	1.7 (3.75)	3.4 (7.50)	5.4 (11.91)
• With integrated line filter	kg (lb)	1.9 (4.19)	3.6 (7.94)	6 (13.23)

¹⁾ The rated output current I_{rated} and the base-load current I_L are based on the duty cycle for low overload (LO).

²⁾ The base-load current I_H is based on the duty cycle for high overload (HO).

³⁾ Typical values. You can find more information on the Internet at <https://support.industry.siemens.com/cs/document/94059311>

⁴⁾ The input current depends on the motor load and line impedance and applies for a line impedance corresponding to $u_K = 1\%$. The rated input currents apply for a load at rated power (based on I_{rated}) – these current values are specified on the rating plate.

⁵⁾ Max. motor cable length 25 m (82 ft) (shielded) for PM230 Power Modules with integrated line filter to maintain the limit values acc. to EN 61800-3 Category C2. With unshielded cables, Category C2 is not achieved.

SINAMICS G120P built-in and wall-mounted units

PM230 Power Modules, 0.37 kW to 90 kW

PM230 Power Modules

Characteristic curves

Derating data

Pulse frequency

Rated power ¹⁾		Rated output current in A for a pulse frequency of						
400 V	460 V							
kW	hp	4 kHz	6 kHz	8 kHz	10 kHz	12 kHz	14 kHz	16 kHz
0.37	0.5	1.3	1.11	0.91	0.78	0.65	0.59	0.52
0.55	0.5	1.7	1.45	1.19	1.02	0.85	0.77	0.68
0.75	0.75	2.2	1.87	1.54	1.32	1.1	0.99	0.88
1.1	1	3.1	2.64	2.17	1.86	1.55	1.4	1.24
1.5	2	4.1	3.49	2.87	2.46	2.05	1.85	1.64
2.2	3	5.9	5.02	4.13	3.54	2.95	2.66	2.36
3	3	7.7	6.55	5.39	4.62	3.85	3.47	3.08
4	5	10.2	8.67	7.14	6.12	5.1	4.59	4.08
5.5	7.5	13.2	11.22	9.24	7.92	6.6	5.94	5.28
7.5	10	18	15.3	12.6	10.8	9	8.1	7.2
11	15	26	22.1	18.2	15.6	13	11.7	10.4
15	15	32	27.2	22.4	19.2	16	14.4	12.8
18.5	20	38	32.3	26.6	22.8	19	17.1	15.2
22	25	45	38.25	31.5	27	22.5	20.25	18
30	30	60	51	42	36	30	27	24
37	40	75	63.75	52.5	45	37.5	33.75	30
45	50	90	76.5	63	54	45	40.5	36
55	60	110	93.5	77	66 ²⁾	55 ²⁾	49.5 ²⁾	44 ²⁾
75	75	145	123.3	101.5	–	–	–	–
90	100	178	151.3	124.6	–	–	–	–

¹⁾ Rated power based on the rated output current I_{rated} . The rated output current I_{rated} is based on the duty cycle for low overload (LO).

²⁾ Values apply only to IP20 variants.

SINAMICS G120P built-in and wall-mounted units

PM230 Power Modules, 0.37 kW to 90 kW

PM230 Power Modules

Characteristic curves (continued)

Ambient temperature

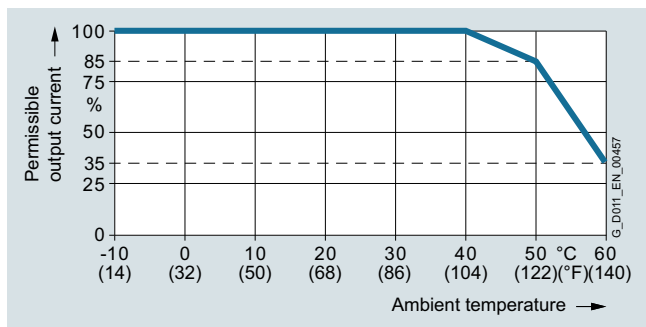

Permissible output current as a function of the ambient temperature for low overload (LO) for PM230 Power Modules, frame sizes FSA to FSC

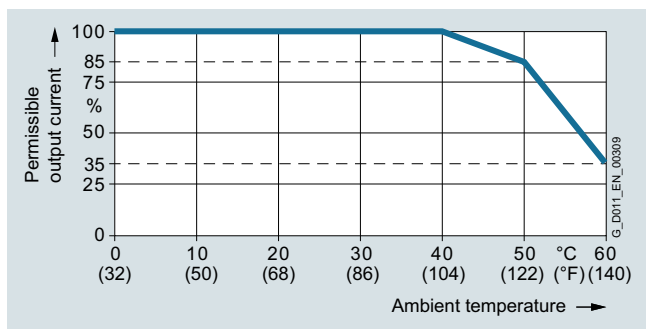

Permissible output current as a function of the ambient temperature for low overload (LO) for PM230 Power Modules, frame sizes FSD to FSF

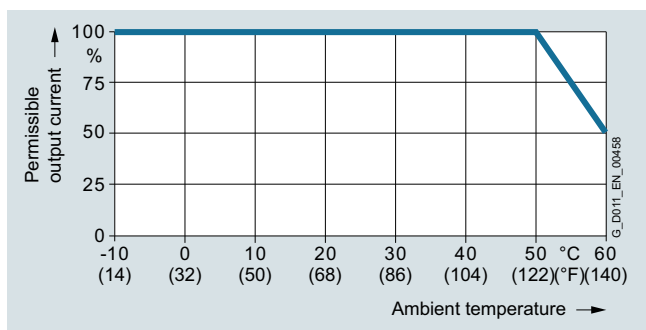

Permissible output current as a function of the ambient temperature for high overload (HO) PM230 Power Modules, frame sizes FSA to FSC

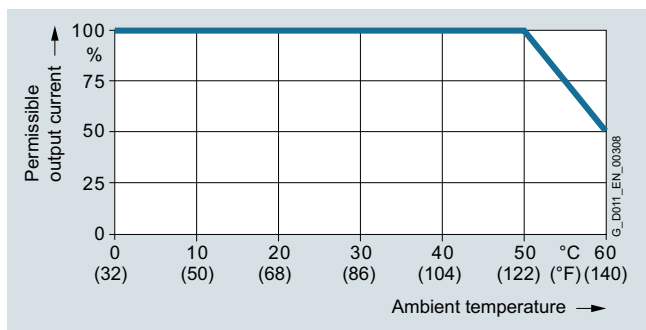

Permissible output current as a function of the ambient temperature for high overload (HO) PM230 Power Modules, frame sizes FSD to FSF

Note:

The operating temperature ranges of the Control Units should be taken into account. The temperature ranges are specified in the section Technical specifications under Control Units.

Installation altitude

Permissible line supplies depending on the installation altitude

- Installation altitude up to 2000 m (6562 ft) above sea level
 - Connection to every supply system permitted for the inverter
- Installation altitudes between 2000 m (6562 ft) and 4000 m (13124 ft) above sea level
 - Connection to a TN system with grounded neutral point
 - TN systems with grounded line conductor are not permitted
 - The TN line system with grounded neutral point can also be supplied using an isolation transformer
 - The phase-to-phase voltage does not have to be reduced

Note:

The connected motors, power elements and components must be considered separately.

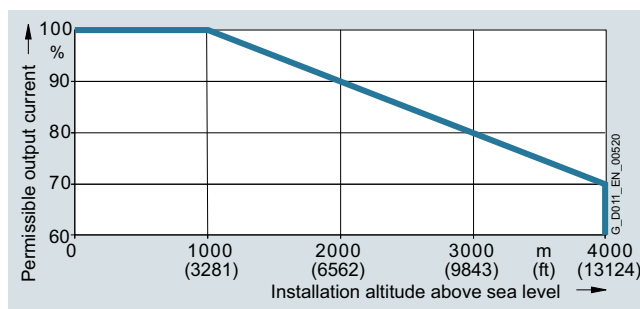

Permissible output current as a function of the installation altitude for PM230 Power Modules, frame sizes FSA to FSF

System operating voltage

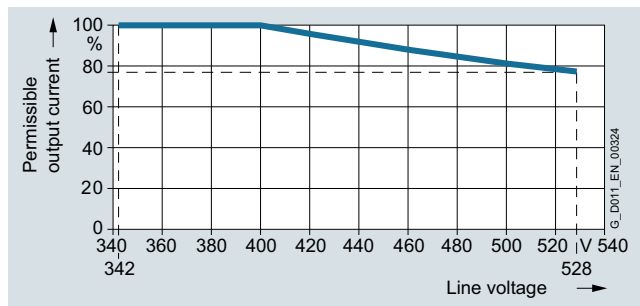

Permissible output current as a function of the line voltage for PM230 Power Modules, frame sizes FSA to FSF

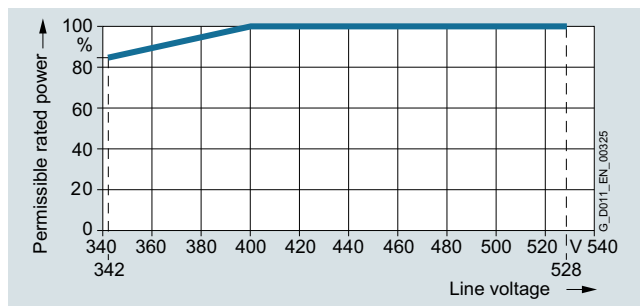

Permissible rated power as a function of the line voltage for PM230 Power Modules, frame sizes FSA to FSF

More information on the derating data of the PM230 Power Modules is available in the Hardware Installation Manual on the Internet at:

www.siemens.com/sinamics-g120p/documentation

SINAMICS G120P built-in and wall-mounted units

PM230 Power Modules, 0.37 kW to 90 kW

PM230 Power Modules

Dimensional drawings

PM230 Power Modules, degree of protection IP55

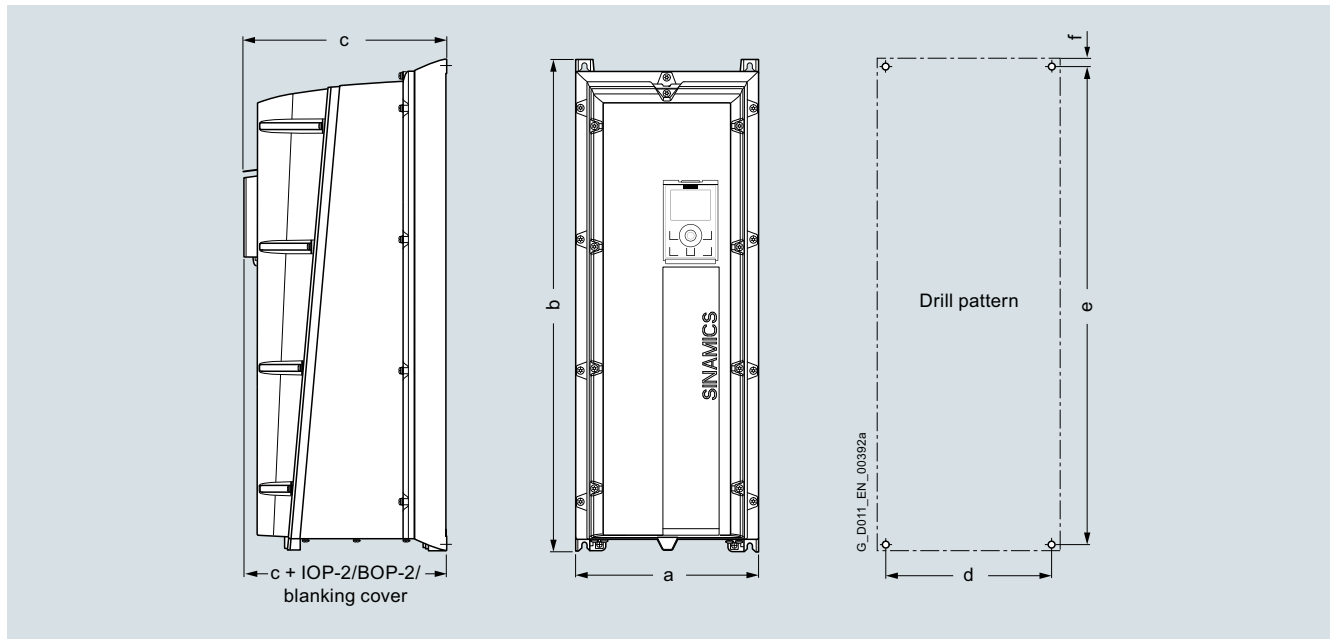

Principle dimension drawing and drill pattern for PM230 Power Modules, degree of protection IP55, with integrated line filter class A/B

Frame size	Dimensions in mm (inches)			Drilling dimensions in mm (inches)			Cooling clearance in mm (inches)			Mounting With bolts, nuts and washers
	a (width)	b (height)	c (depth) ¹⁾	d	e	f	top	bottom	side	
PM230 Power Modules, degree of protection IP55 with integrated line filter class A/B										
FSA	154 (6.06)	460 (18.11)	249 (9.8)	132 (5.19)	445 (17.51)	11 (0.43)	100 (3.94)	0 (0)	0 (0)	4 × M4
FSB	180 (7.08)	540 (21.25)	249 (9.8)	158 (5.9)	524 (20.62)	11 (0.43)	100 (3.94)	0 (0)	0 (0)	4 × M4
FSC	230 (9.05)	620 (24.4)	249 (9.8)	208 (8.18)	604 (23.77)	11 (0.43)	125 (4.92)	0 (0)	0 (0)	4 × M5
FSD	320 (12.59)	640 (25.19)	329 (12.95)	285 (11.22)	600 (23.62)	17.5 (0.69)	300 (11.81)	0 (0)	50 (1.97) ²⁾	4 × M8
FSE	320 (12.59)	751 (29.56)	329 (12.95)	285 (11.22)	710 (27.95)	17.5 (0.69)	300 (11.81)	0 (0)	50 (1.97) ²⁾	4 × M8
FSF	410 (16.14)	915 (36.02)	416 (16.38)	370 (14.56)	870 (34.25)	20 (0.79)	350 (13.78)	0 (0)	50 (1.97) ²⁾	4 × M8

¹⁾ Increased depth:

- When the IOP-2/BOP-2/blanking cover is plugged on, the depth increases by 7 mm (0.28 in)

²⁾ Up to 40 °C (104 °F) without any lateral clearance.

SINAMICS G120P built-in and wall-mounted units

PM230 Power Modules, 0.37 kW to 90 kW

PM230 Power Modules

Dimensional drawings (continued)

PM230 Power Modules, degree of protection IP20, Standard variant

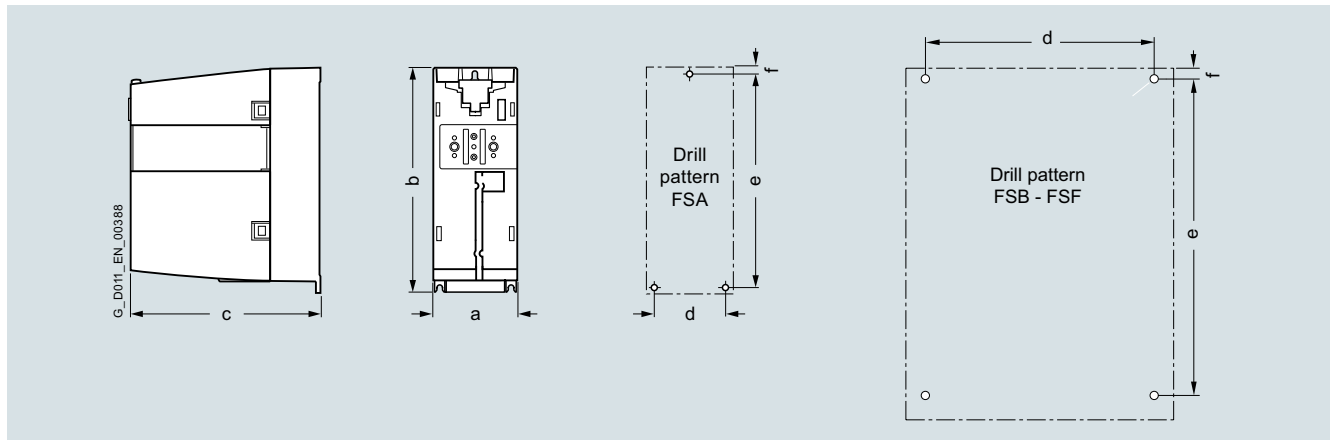

Principle dimension drawing and drill pattern for PM230 Power Modules, degree of protection IP20, Standard variant, with/without integrated line filter class A

Frame size	Dimensions in mm (inches)			Drilling dimensions in mm (inches)			Cooling clearance in mm (inches)			Mounting With bolts
	a (width)	b (height)	c (depth) ¹⁾	d	e	f	top	bottom	side ²⁾	
PM230 Power Modules, degree of protection IP20, Standard variant, with/without integrated line filter class A										
FSA	73 (2.87)	196 (7.72)	165 (6.5)	62.3 (2.45)	186 (7.32)	6 (0.24)	80 (3.15)	100 (3.94)	0 (0)	3 × M4
FSB	100 (3.94)	292 (11.5)	165 (6.5)	80 (3.15)	281 (11.06)	6 (0.24)	80 (3.15)	100 (3.94)	0 (0)	4 × M4
FSC	140 (5.51)	355 (13.98)	165 (6.5)	120 (4.72)	343 (13.5)	6 (0.24)	80 (3.15)	100 (3.94)	0 (0)	4 × M5
FSD	275 (10.83)	419/512 (16.50/20.16)	204 (8.03)	235 (9.25)	325/419 (12.8/16.5)	11 (0.43)	300 (11.81)	300 (11.81)	0 (0)	4 × M6
FSE	275 (10.83)	499/635 (19.65/25)	204 (8.03)	235 (9.25)	405/541 (15.94/21.3)	11 (0.43)	300 (11.81)	300 (11.81)	0 (0)	4 × M6
FSF	350 (13.78)	634/934 (24.96/36.77)	316 (12.44)	300 (11.81)	598/899 (23.54/35.39)	11 (0.43)	350 (13.78)	350 (13.78)	0 (0)	4 × M8

¹⁾ Increased depth:

- When the CU230P-2 Control Unit is plugged on, the depth increases by 58 mm (2.28 in) for FSA to FSC and by 49 mm (1.93 in) for FSD to FSF
- When the IOP-2/BOP-2 is plugged on, the depth increases by a further 12 mm (0.47 in)

²⁾ The Power Modules can be mounted side by side. A side clearance of 1 mm (0.04 in) is recommended for tolerance-related reasons.

SINAMICS G120P built-in and wall-mounted units

PM230 Power Modules, 0.37 kW to 90 kW

PM230 Power Modules

Dimensional drawings (continued)

PM230 Power Modules, degree of protection IP20, Push Through variant

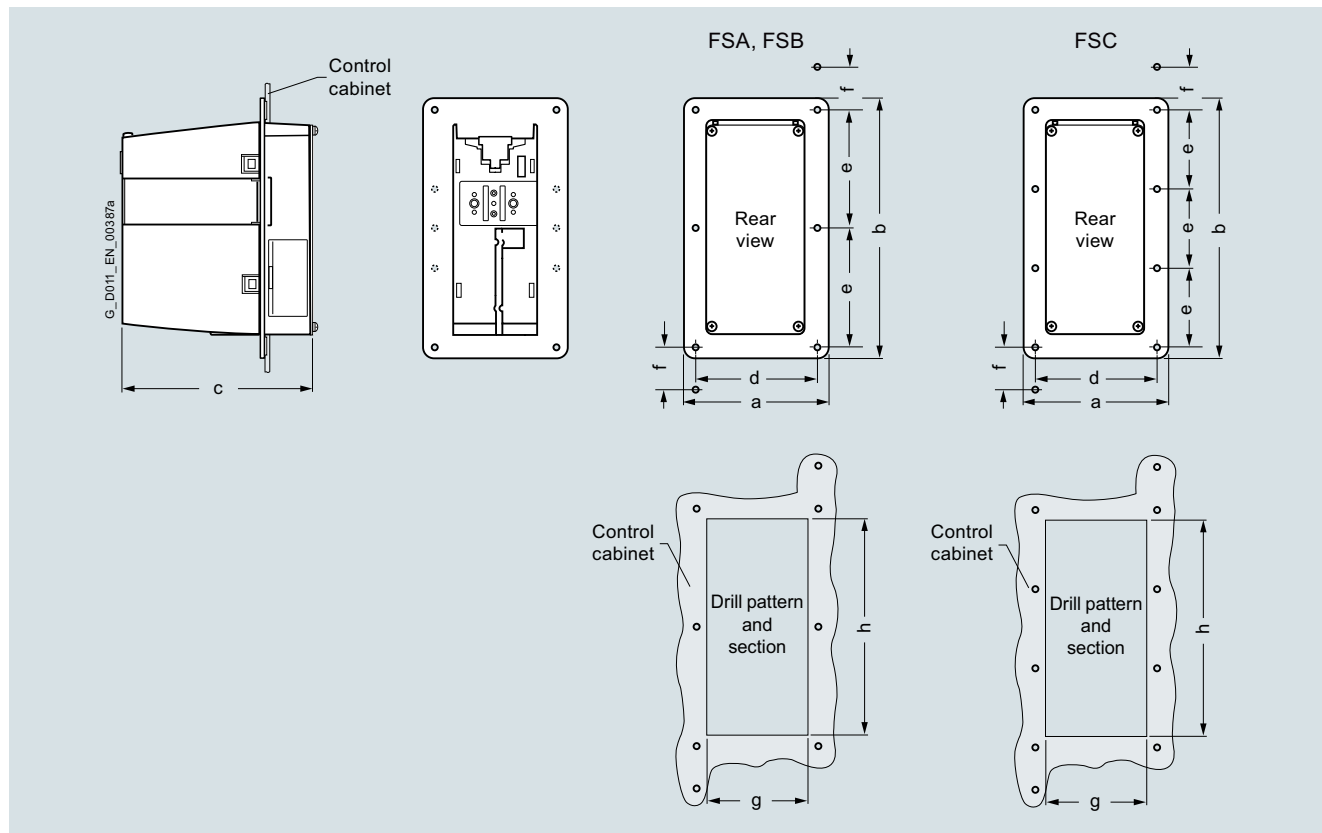

Principle dimension drawing and drill pattern for PM230 Power Modules, degree of protection IP20, Push Through variant, with/without integrated line filter class A

Frame size	Dimensions in mm (inches)			Drilling dimensions in mm (inches)			Section of cabinet in mm (inches)		Cooling clearance in mm (inches)			Mounting With bolts
	a (width)	b (height)	c (depth) ¹⁾	d	e	f	g (width)	h (height)	top	bottom	side ²⁾	
PM230 Power Modules, degree of protection IP20, Push Through variant, with/without integrated line filter class A												
FSA	125.9 (4.96)	238 (9.37)	171 (6.73)	106 (4.17)	103 (4.06)	27 (1.06)	88 (3.46)	198 (7.8)	80 (3.15)	100 (3.94)	0 (0)	M5
FSB	153.9 (6.06)	345 (13.58)	171 (6.73)	134 (5.28)	147.5 (5.81)	34.5 (1.36)	116 (4.57)	304 (11.97)	80 (3.15)	100 (3.94)	0 (0)	M5
FSC	200 (7.87)	410.5 (16.16)	171 (6.73)	174 (6.85)	123 (4.84)	30.5 (1.2)	156 (6.14)	365 (14.37)	80 (3.15)	100 (3.94)	0 (0)	M5

¹⁾ Overall depth, of which 117.7 mm (4.63 in) is inside and 53.1 mm (2.09 in) is outside the control cabinet. Increased depth:

- When the CU230P-2 Control Unit is plugged on, the depth increases by 58 mm (2.28 in)
- When the IOP-2/BOP-2 is plugged on, the depth increases by a further 12 mm (0.47 in)

SINAMICS G120P built-in and wall-mounted units

PM230 Power Modules, 0.37 kW to 90 kW

Line filter

Overview



With an additional line filter, the Power Module reaches a higher radio interference class.

Line filter for Power Modules frame size FSA

Integration

Frame sizes FSA to FSF of the PM230 Power Module in degree of protection IP20 are available both with and without an integrated line filter class A.

Line filters that are optionally available depending on the Power Module used

	Frame size					
	FSA	FSB	FSC	FSD	FSE	FSF
PM230 Power Module, degree of protection IP55/UL Type 12						
Available frame sizes	✓	✓	✓	✓	✓	✓
Line-side power components						
Line filter class A	I	I	I	I	I	I
Line filter class B	I	I	I	I	I	I
PM230 Power Module, degree of protection IP20						
Available frame sizes	✓	✓	✓	✓	✓	✓
Line-side power components						
Line filter class A	F	F	F	F	F	F
Line filter class B	U	U	U	S	S	S

U = Base component

S = Lateral mounting

I = Integrated

F = Power Modules available with and without integrated filter class A

– = Not possible

¹⁾ Lateral mounting is the only possible option for Push Through variants.

SINAMICS G120P built-in and wall-mounted units

PM230 Power Modules, 0.37 kW to 90 kW

Line filter

Selection and ordering data

Rated power		SINAMICS G120P PM230 Power Module Degree of protection IP20 Standard variant		Line filter class B according to EN 55011
400 V kW	460 V hp	Type 6SL3210-...	Frame size	Article No.
380 ... 480 V 3 AC				
0.37	0.5	1NE11-3UG1	FSA	6SL3203-0BE17-7BA0
0.55	0.5	1NE11-7UG1		
0.75	0.75	1NE12-2UG1		
1.1	1	1NE13-1UG1		
1.5	2	1NE14-1UG1		
2.2	3	1NE15-8UG1		
3	3	1NE17-7UG1		
4	5	1NE21-0UG1	FSB	6SL3203-0BE21-8BA0
5.5	7.5	1NE21-3UG1		
7.5	10	1NE21-8UG1		
11	15	1NE22-6UG1	FSC	6SL3203-0BE23-8BA0
15	15	1NE23-2UG1		
18.5	20	1NE23-8UG1		
22	25	1NE24-5UL0	FSD	6SL3203-0BE27-5BA0
30	30	1NE26-0UL0		
37	40	1NE27-5UL0	FSE	6SL3203-0BE31-1BA0
45	50	1NE28-8UL0		
55	60	1NE31-1UL0	FSF	6SL3203-0BE31-8BA0
75	75	1NE31-5UL0		

Rated power		SINAMICS G120P PM230 Power Module Degree of protection IP20 Push Through variant		Line filter class B according to EN 55011
400 V kW	460 V hp	Type 6SL3211-...	Frame size	Article No.
380 ... 480 V 3 AC				
3	3	1NE17-7UG1	FSA	6SL3203-0BE17-7BA0
7.5	10	1NE21-8UG1	FSB	6SL3203-0BE21-8BA0
18.5	20	1NE23-8UG1	FSC	6SL3203-0BE23-8BA0

4

SINAMICS G120P built-in and wall-mounted units

PM230 Power Modules, 0.37 kW to 90 kW

Line filter

Technical specifications

Line voltage 380 ... 480 V 3 AC		Line filter class B					
		6SL3203-0BE17-7BA0	6SL3203-0BE21-8BA0	6SL3203-0BE23-8BA0	6SL3203-0BE27-5BA0	6SL3203-0BE31-1BA0	6SL3203-0BE31-8BA0
Rated current	A	11.4	23.5	49.4	72	105	204
Pulse frequency	kHz	4 ... 16	4 ... 16	4 ... 16	4 ... 16	4 ... 16	4 ... 8
Line supply connection L1, L2, L3		Screw-type terminals	Screw-type terminals	Screw-type terminals	Screw-type terminals	Screw-type terminals	Screw-type terminals
• Conductor cross-section	mm ²	1 ... 2.5	2.5 ... 6	6 ... 16	16 ... 50	16 ... 50	35 ... 150
Load connection U, V, W		Shielded cable	Shielded cable	Shielded cable	Shielded cable	Shielded cable	Shielded cable
• Cable cross-section	mm ²	1.5	4	10	16	35	50
• Length	m (ft)	0.45 (1.48)	0.5 (1.64)	0.54 (1.77)	1 (3.28)	1 (3.28)	1.1 (3.61)
PE connection		On housing via M5 screw stud	On housing via M5 screw stud	On housing via M6 screw studs	On housing via M6 screw studs	On housing via M8 screw studs	On housing via M10 screw studs
• Conductor cross-section	mm ²	1 ... 2.5	2.5 ... 6	6 ... 16	16 ... 50	35 ... 50	50 ... 150
Degree of protection		IP20	IP20	IP20	IP20	IP20	IP20
Dimensions							
• Width	mm (in)	73 (2.87)	100 (3.94)	140 (5.51)	100 (3.94)	110 (4.33)	150 (5.91)
• Height	mm (in)	202 (7.95)	297 (11.7)	359 (14.1)	400 (15.7)	480 (18.9)	517
• Depth	mm (in)	65 (2.56)	85 (3.35)	95 (3.74)	140 (5.51)	140 (5.51)	230 (9.06)
Possible as base component		Yes	Yes	Yes	No	No	No
Weight, approx.	kg (lb)	1.75 (3.86)	4 (8.82)	7.3 (16.1)	7.6 (16.8)	11.9 (26.2)	21.7 (47.8)
Suitable for PM230 Power Module degree of protection IP20 standard variant	Type	6SL3210-1NE11-3UG1 6SL3210-1NE11-7UG1 6SL3210-1NE12-2UG1 6SL3210-1NE13-1UG1 6SL3210-1NE14-1UG1 6SL3210-1NE15-8UG1 6SL3210-1NE17-7UG1	6SL3210-1NE21-0UG1 6SL3210-1NE21-3UG1 6SL3210-1NE21-8UG1	6SL3210-1NE22-6UG1 6SL3210-1NE23-2UG1 6SL3210-1NE23-8UG1	6SL3210-1NE24-5UL0 6SL3210-1NE26-0UL0	6SL3210-1NE27-5UL0 6SL3210-1NE28-8UL0	6SL3210-1NE31-1UL0 6SL3210-1NE31-5UL0
Suitable for PM230 Power Module degree of protection IP20 Push Through variant (lateral mounting only)	Type	6SL3211-1NE17-7UG1	6SL3211-1NE21-8UG1	6SL3211-1NE23-8UG1	–	–	–
• Frame size		FSA	FSB	FSC	FSD	FSE	FSF

SINAMICS G120P built-in and wall-mounted units

PM230 Power Modules, 0.37 kW to 90 kW

Recommended line-side overcurrent protection devices

Selection and ordering data

Overcurrent protection devices are absolutely necessary for the operation of the inverters. The following tables list recommendations for fuses and circuit breakers.

Notes for use in compliance with IEC standards:

Siemens fuses of type 3NA3 or 3NE1 or Siemens circuit breakers of type 3VL are recommended for European countries.

Notes for use in compliance with UL regulations:

UL-listed fuses Class J or Siemens fuses of type 3NE1 with 600 V AC rated voltage (UL-compliant – corresponds to **RA**) are required for North America.

The Short-Circuit Current Rating (SCCR) according to UL for industrial control panel installations to NEC Article 409 or UL 508A/508C is as follows for

- PM230 IP55 versions:
 - 40 kA (frame sizes FSA to FSC)
 - 65 kA (frame sizes FSD to FSF)
- PM230 IP20 versions: 65 kA

Notes regarding installations in Canada:

Overvoltage protection devices in accordance with overvoltage category III and with the following ratings must be connected on the line side of the inverter:

- Rated voltage 480 V (phase-phase) and 480 V (phase-ground)
- Voltage limit 4 kV (phase-phase) and 6 kV (phase-ground)

More information is available in the technical documentation on the Internet at:

www.siemens.com/sinamics-g120/documentation

All overvoltage protection devices used must comply with Canadian standards for industrial installations.

More information about the listed Siemens fuses and circuit breakers is available in Catalogs LV 10, IC 10 and IC 10 AO as well as in the Industry Mall.

Rated power ¹⁾		SINAMICS G120P PM230 Power Modules Degree of protection IP55/UL Type 12		IEC-compliant			UL/cUL-compliant	
400 V kW	460 V hp	Type 6SL3223-...	Frame size	Fuse Current A	Type 3NA3 Article No.	Circuit breaker Article No.	Fuse type Rated voltage 600 V AC Class	Current A
380 ... 480 V 3 AC								
0.37	0.5	ODE13-7 . G1	FSA	10	3NA3803	3RV2011-1CA10	J	10
0.55	0.5	ODE15-5 . G1	FSA			3RV2011-1DA10		
0.75	0.75	ODE17-5 . G1	FSA			3RV2011-1FA10		
1.1	1	ODE21-1 . G1	FSA			3RV2011-1GA10		
1.5	2	ODE21-5 . G1	FSA			3RV2011-1JA10		
2.2	3	ODE22-2 . G1	FSA			3RV2011-1KA10		
3	3	ODE23-0 . G1	FSA			3RV2021-4AA10		
4	5	ODE24-0 . G1	FSB	16	3NA3805	3RV2021-4BA10	J	16
5.5	7.5	ODE25-5 . G1	FSB	20	3NA3807		J	25
7.5	10	ODE27-5 . G1	FSB	25	3NA3810	3RV1031-4EA10	J	35
11	15	ODE31-1 . G1	FSC	35	3NA3814	3RV1031-4FA10	J	40
15	15	ODE31-5 . G1	FSC	50	3NA3820	3RV1031-4HA10	J	50
18.5	20	ODE31-8AG1	FSC			3RV1042-4KA10		
		ODE31-8BA0	FSD					
22	25	ODE32-2 . A0	FSD	63	3NA3822		J	63
30	30	ODE33-0 . A0	FSD	80	3NA3824		J	80
37	40	ODE33-7 . A0	FSE	100	3NA3830		J	100
45	50	ODE34-5 . A0	FSE	125	3NA3832		J	125
55	60	ODE35-5 . A0	FSF	160	3NA3836		J	160
75	75	ODE37-5 . A0	FSF	200	3NA3140		J	200
90	100	ODE38-8 . A0	FSF	250	3NA3144		J	250

¹⁾ Rated power based on the rated output current I_{rated} . The rated output current I_{rated} is based on the duty cycle for low overload (LO).

SINAMICS G120P built-in and wall-mounted units

PM230 Power Modules, 0.37 kW to 90 kW

Recommended line-side overcurrent protection devices

Selection and ordering data (continued)

Rated power ¹⁾		SINAMICS G120 PM230 Power Modules Degree of protection IP20 Standard variant		IEC-compliant Fuse		UL/cUL-compliant Fuse			
400 V kW	460 V hp	Type 6SL3210-...	Frame size	Current A	Type 3NE1 (⚡) Article No.	Type 3NE1 (⚡) Article No.	Fuse type Rated voltage 600 V AC		
								Class	Current A
380 ... 480 V 3 AC									
0.37	0.5	1NE11-3 . G1	FSA	16	3NE1813-0	3NE1813-0	J	2	
0.55	0.5	1NE11-7 . G1	FSA				J	4	
0.75	0.75	1NE12-2 . G1	FSA						
1.1	1	1NE13-1 . G1	FSA				J	6	
1.5	2	1NE14-1 . G1	FSA						
2.2	3	1NE15-8 . G1	FSA				J	10	
3	3	1NE17-7 . G1	FSA						
4	5	1NE21-0 . G1	FSB				J	15	
5.5	7.5	1NE21-3 . G1	FSB	20	3NE1814-0	3NE1814-0	J	20	
7.5	10	1NE21-8 . G1	FSB	25	3NE1815-0	3NE1815-0	J	25	
11	15	1NE22-6 . G1	FSC	35	3NE1803-0	3NE1803-0	J	35	
15	15	1NE23-2 . G1	FSC	45	3NE1817-0	3NE1817-0	J	45	
18.5	20	1NE23-8 . G1	FSC	50			J	50	
22	25	1NE24-5 . L0	FSD	63	3NE1818-0	3NE1818-0	–	–	
30	30	1NE26-0 . L0	FSD	80	3NE1820-0	3NE1820-0	–	–	
37	40	1NE27-5 . L0	FSE	100	3NE1021-0	3NE1021-0	–	–	
45	50	1NE28-8 . L0	FSE	125	3NE1022-0	3NE1022-0	–	–	
55	60	1NE31-1 . L0	FSF	160	3NE1224-0	3NE1224-0	–	–	
75	75	1NE31-5 . L0	FSF	200	3NE1225-0	3NE1225-0	–	–	

Rated power ¹⁾		SINAMICS G120 PM230 Power Modules Degree of protection IP20 Push Through variant		IEC-compliant Fuse		UL/cUL-compliant Fuse			
400 V kW	460 V hp	Type 6SL3211-...	Frame size	Current A	Type 3NE1 (⚡) Article No.	Type 3NE1 (⚡) Article No.	Fuse type Rated voltage 600 V AC		
								Class	Current A
380 ... 480 V 3 AC									
3	3	1NE17-7 . G1	FSA	16	3NE1813-0	3NE1813-0	J	10	
7.5	10	1NE21-8 . G1	FSB	25	3NE1815-0	3NE1815-0	J	25	
18.5	20	1NE23-8 . G1	FSC	50	3NE1817-0	3NE1817-0	J	50	

¹⁾ Rated power based on the rated output current I_{rated} . The rated output current I_{rated} is based on the duty cycle for low overload (LO).

SINAMICS G120P built-in and wall-mounted units

PM230 Power Modules, 0.37 kW to 90 kW

Output reactors

Overview

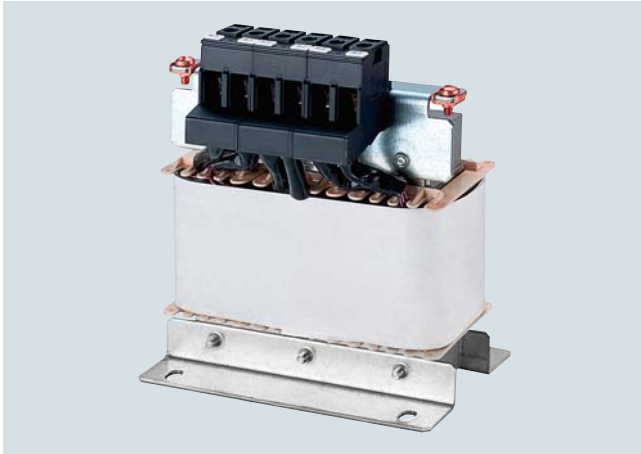

Output reactor for PM230 Power Modules, frame size FSA

Output reactors reduce the rate of voltage rise (dv/dt) and the height of the current peaks, and enable longer motor cables to be connected.

Owing to the high rates of voltage rise of the fast-switching IGBTs, the capacitance of long motor cables reverses polarity very quickly with every switching operation in the inverter. As a result, the inverter is loaded with additional current peaks of substantial magnitude.

Output reactors reduce the magnitude of these additional peaks because the cable capacitance reverses polarity more slowly across the reactor inductance, thereby attenuating the amplitudes of the current peaks.

When using output reactors, the following should be observed:

- Max. permissible output frequency 200 Hz
- Max. permissible pulse frequency 4 kHz
- The output reactor must be installed as close as possible to the Power Module

Integration

Output reactors that are optionally available depending on the Power Module used

The following load-side power components are optionally available in the appropriate frame sizes for the Power Modules:

	Frame size					
	FSA	FSB	FSC	FSD	FSE	FSF
PM230 Power Module, degree of protection IP20 and/or IP55						
Available frame sizes	✓	✓	✓	✓	✓	✓
Load-side power components						
Output reactor	S	S	S	S	S	S

S = Lateral mounting

– = Not possible

SINAMICS G120P built-in and wall-mounted units

PM230 Power Modules, 0.37 kW to 90 kW

Output reactors**Selection and ordering data**

Rated power		SINAMICS G120P PM230 Power Modules degree of protection <u>IP20</u>	SINAMICS G120P PM230 Power Modules Degree of protection <u>IP55/UL Type 12</u>		Output reactor
400 V kW	460 V hp	Type 6SL3210-...	Type 6SL3223-...	Frame size	Article No.
380 ... 480 V 3 AC					
0.37	0.5	1NE11-3 . G1	0DE13-7 . G1	FSA	6SL3202-0AE16-1CA0
0.55	0.5	1NE11-7 . G1	0DE15-5 . G1		
0.75	0.75	1NE12-2 . G1	0DE17-5 . G1		
1.1	1	1NE13-1 . G1	0DE21-1 . G1		
1.5	2	1NE14-1 . G1	0DE21-5 . G1		
2.2	3	1NE15-8 . G1	0DE22-2 . G1		
3	3	1NE17-7 . G1	0DE23-0 . G1	FSA	6SL3202-0AE18-8CA0
4	5	1NE21-0 . G1	0DE24-0 . G1	FSB	6SL3202-0AE21-8CA0
5.5	7.5	1NE21-3 . G1	0DE25-5 . G1		
7.5	10	1NE21-8 . G1	0DE27-5 . G1		
11	15	1NE22-6 . G1	0DE31-1 . G1	FSC	6SL3202-0AE23-8CA0
15	15	1NE23-2 . G1	0DE31-5 . G1		
18.5	20	1NE23-8 . G1	0DE31-8AG1		
18.5	20	–	0DE31-8BA0	FSD	6SE6400-3TC03-8DD0
22	25	1NE24-5 . L0	0DE32-2 . A0	FSD	6SE6400-3TC03-8DD0
30	30	1NE26-0 . L0	0DE33-0 . A0	FSD	6SE6400-3TC05-4DD0
37	40	1NE27-5 . L0	0DE33-7 . A0	FSE	6SE6400-3TC08-0ED0
45	50	1NE28-8 . L0	0DE34-5 . A0	FSE	6SE6400-3TC07-5ED0
55	60	1NE31-1 . L0	0DE35-5 . A0	FSF	6SE6400-3TC14-5FD0
75	75	1NE31-5 . L0	0DE37-5 . A0	FSF	6SE6400-3TC15-4FD0
90	100	–	0DE38-8 . A0	FSF	6SE6400-3TC14-5FD0
Rated power		SINAMICS G120P PM230 Power Module Degree of protection IP20 Push Through variant			Output reactor
400 V kW	460 V hp	Type 6SL3211-...		Frame size	Article No.
380 ... 480 V 3 AC					
3	3	1NE17-7 . G1		FSA	6SL3202-0AE18-8CA0
7.5	10	1NE21-8 . G1		FSB	6SL3202-0AE21-8CA0
18.5	20	1NE23-8 . G1		FSC	6SL3202-0AE23-8CA0

SINAMICS G120P built-in and wall-mounted units

PM230 Power Modules, 0.37 kW to 90 kW

Output reactors

Technical specifications

Line voltage 380 ... 480 V 3 AC		Output reactor			
		6SL3202-0AE16-1CA0	6SL3202-0AE18-8CA0	6SL3202-0AE21-8CA0	6SL3202-0AE23-8CA0
Rated current	A	6.1	9	18.5	39
Power loss	kW	0.09	0.08	0.08	0.11
Connection to the Power Module		Screw-type terminals	Screw-type terminals	Screw-type terminals	Screw-type terminals
• Conductor cross-section	mm ²	4	4	10	16
Motor connection		Screw-type terminals	Screw-type terminals	Screw-type terminals	Screw-type terminals
• Conductor cross-section	mm ²	4	4	10	16
PE connection		M4 screw stud	M4 screw stud	M5 screw stud	M5 screw stud
Cable length, max. between output reactor and motor					
• 380 V -10 % ... 415 V +10 % 3 AC					
- Shielded	m (ft)	150 (492)	150 (492)	150 (492)	150 (492)
- Unshielded	m (ft)	225 (738)	225 (738)	225 (738)	225 (738)
• 440 ... 480 V 3 AC +10 %					
- Shielded	m (ft)	100 (328)	100 (328)	100 (328)	100 (328)
- Unshielded	m (ft)	150 (492)	150 (492)	150 (492)	150 (492)
Dimensions					
• Width	mm (in)	207 (8.15)	207 (8.15)	247 (9.72)	257 (10.12)
• Height	mm (in)	175 (6.89)	180 (7.09)	215 (8.46)	235 (9.25)
• Depth	mm (in)	72.5 (2.85)	72.5 (2.85)	100 (3.94)	114.7 (4.52)
Possible as base component		No	No	No	No
Degree of protection		IP20	IP20	IP20	IP20
Weight, approx.	kg (lb)	3.4 (7.50)	3.9 (8.60)	10.1 (22.3)	11.2 (24.7)
Suitable for PM230 Power Module degree of protection IP20	Type	6SL3210-1NE11-3 . G1 6SL3210-1NE11-7 . G1 6SL3210-1NE12-2 . G1 6SL3210-1NE13-1 . G1 6SL3210-1NE14-1 . G1 6SL3210-1NE15-8 . G1	6SL3210-1NE17-7 . G1	6SL3210-1NE21-0 . G1 6SL3210-1NE21-3 . G1 6SL3210-1NE21-8 . G1	6SL3210-1NE22-6 . L1 6SL3210-1NE23-2 . L1 6SL3210-1NE23-8 . L1
Suitable for PM230 Power Module degree of protection IP20 Push Through variant	Type	-	6SL3211-1NE17-7 . G1	6SL3211-1NE21-8 . G1	6SL3211-1NE23-8 . L1
Suitable for PM230 Power Module degree of protection IP55/UL Type 12	Type	6SL3223-0DE13-7 . G1 6SL3223-0DE15-5 . G1 6SL3223-0DE17-5 . G1 6SL3223-0DE21-1 . G1 6SL3223-0DE21-5 . G1 6SL3223-0DE22-2 . G1	6SL3223-0DE23-0 . G1	6SL3223-0DE24-0 . G1 6SL3223-0DE25-5 . G1 6SL3223-0DE27-5 . G1	FSC: 6SL3223-0DE31-1 . G1 6SL3223-0DE31-5 . G1 6SL3223-0DE31-8AG1 FSD: 6SL3223-0DE31-8BA0
• Frame size		FSA	FSA	FSB	FSC/FSD

SINAMICS G120P built-in and wall-mounted units

PM230 Power Modules, 0.37 kW to 90 kW

Output reactors

Technical specifications (continued)

Line voltage 380 ... 480 V 3 AC		Output reactor			
		6SE6400-3TC03-8DD0	6SE6400-3TC05-4DD0	6SE6400-3TC08-0ED0	6SE6400-3TC07-5ED0
Rated current	A	45 ¹⁾	68 ¹⁾	104 ¹⁾	90 ¹⁾
Power loss	kW	0.2	0.2	0.17	0.27
Connection to the Power Module		Flat connector for M6 cable lug	Flat connector for M6 cable lug	Flat connector for M6 cable lug	Flat connector for M6 cable lug
Motor connection		Flat connector for M6 cable lug	Flat connector for M6 cable lug	Flat connector for M6 cable lug	Flat connector for M6 cable lug
PE connection		M6 screw	M6 screw	M6 screw	M6 screw
Cable length, max. between output reactor and motor					
• 380 V -10 % ... 480 V +10 % 3 AC					
- Shielded	m (ft)	200 (656)	200 (656)	200 (656)	200 (656)
- Unshielded	m (ft)	300 (984)	300 (984)	300 (984)	300 (984)
Dimensions					
• Width	mm (in)	225 (8.86)	225 (8.86)	225 (8.86)	270 (10.63)
• Height	mm (in)	210 (8.27)	210 (8.27)	210 (8.27)	248 (9.76)
• Depth	mm (in)	179 (7.05)	150 (5.91)	150 (5.91)	209 (8.23)
Possible as base component		No	No	No	No
Degree of protection		IP00	IP00	IP00	IP00
Weight, approx.	kg (lb)	16.1 (35.5)	10.7 (23.6)	10.4 (22.9)	24.9 (54.9)
Suitable for PM230 Power Module degree of protection IP20	Type	6SL3210-1NE24-5UL0 6SL3210-1NE24-5AL0	6SL3210-1NE26-0UL0 6SL3210-1NE26-0AL0	6SL3210-1NE27-5UL0 6SL3210-1NE27-5AL0	6SL3210-1NE28-8UL0 6SL3210-1NE28-8AL0
Suitable for PM230 Power Module degree of protection IP55/UL Type 12	Type	6SL3223-0DE32-2UA0 6SL3223-0DE32-2AA0	6SL3223-0DE33-0UA0 6SL3223-0DE33-0AA0	6SL3223-0DE33-7UA0 6SL3223-0DE33-7AA0	6SL3223-0DE34-5UA0 6SL3223-0DE34-5AA0
• Rated power of the Power Module	kW	22	30	37	45
• Rated current I_{rated} of the Power Module	A	45	60	75	90
• Frame size		FSD	FSD	FSE	FSE

¹⁾ On the rating plate of the reactor the current is specified according to the duty cycle for high overload (HO). This is lower than the current specified according to the duty cycle for low overload (LO) of the Power Module.

SINAMICS G120P built-in and wall-mounted units

PM230 Power Modules, 0.37 kW to 90 kW

Output reactors

Technical specifications (continued)

Line voltage 380 ... 480 V 3 AC		Output reactor		
		6SE6400-3TC14-5FD0	6SE6400-3TC15-4FD0	6SE6400-3TC14-5FD0
Rated current	A	178 ¹⁾	178 ¹⁾	178 ¹⁾
Power loss	kW	0.47	0.25	0.47
Connection to the Power Module		Flat connector for M8 cable lug	Flat connector for M8 cable lug	Flat connector for M8 cable lug
Motor connection		Flat connector for M8 cable lug	Flat connector for M8 cable lug	Flat connector for M8 cable lug
PE connection		M8 screw	M6 screw	M8 screw
Cable length, max. between output reactor and motor				
• 380 V -10 % ... 480 V +10 % 3 AC				
- Shielded	m (ft)	200 (656)	200 (656)	200 (656)
- Unshielded	m (ft)	300 (984)	300 (984)	300 (984)
Dimensions				
• Width	mm (in)	350 (13.78)	270 (10.63)	350 (13.78)
• Height	mm (in)	321 (12.64)	248 (9.76)	321 (12.64)
• Depth	mm (in)	288 (11.34)	209 (8.23)	288 (11.34)
Possible as base component		No	No	No
Degree of protection		IP00	IP00	IP00
Weight, approx.	kg (lb)	51.5 (114)	24 (52.9)	51.5 (114)
Suitable for PM230 Power Module degree of protection IP20	Type	6SL3210-1NE31-1UL0 6SL3210-1NE31-1AL0	6SL3210-1NE31-5UL0 6SL3210-1NE31-5AL0	–
Suitable for PM230 Power Module degree of protection IP55/UL Type 12	Type	6SL3223-0DE35-5UA0 6SL3223-0DE35-5AA0	6SL3223-0DE37-5UA0 6SL3223-0DE37-5AA0	6SL3223-0DE38-8UA0 6SL3223-0DE38-8AA0
• Rated power of the Power Module	kW	55	75	90
• Rated current I_{rated} of the Power Module	A	110	145	178
• Frame size		FSF	FSF	FSF

¹⁾ On the rating plate of the reactor the current is specified according to the duty cycle for high overload (HO). This is lower than the current specified according to the duty cycle for low overload (LO) of the Power Module.

SINAMICS G120P built-in and wall-mounted units

PM230 Power Modules, 0.37 kW to 90 kW

Sine-wave filters

Overview



Sine-wave filter

Sine-wave filters limit the rate of voltage rise (dv/dt) and the peak voltages on the motor winding. Similar to an output reactor, they enable the connection of longer motor cables.

Bearing currents are also reduced significantly. Using these filters therefore allows standard motors with standard insulation and without insulated bearings to be operated on SINAMICS.

As a result, the voltage load on the motor winding is virtually identical to the load on windings of directly mains-fed motors.

Owing to the very low rates of voltage rise on the motor cable, the sine-wave filter also has a positive impact in terms of electromagnetic compatibility which means that it is not absolutely essential to use shielded cables for short motor cables to achieve the required standard of EMC.

Since the voltage applied to the motor is not pulsed, the inverter-related stray losses and additional noise in the motor are also reduced considerably and the noise level of the motor is similar to the level produced by directly mains-fed motors.

When using sine-wave filters, the following should be observed:

- Pulse frequencies of between 4 kHz and 8 kHz are permissible for rated outputs up to and including 90 kW
- The output frequency is limited to 150 Hz.
- Operation and commissioning may only be performed with the motor connected as the sine-wave filter is not no-load proof
- It must be ensured that the automatic pulse frequency reduction functions are also deactivated
- 80 % of the line input voltage is available as an output voltage for PM230 Power Modules.

Integration

Sine-wave filters that are optionally available depending on the Power Module used

	Frame size					
	FSA	FSB	FSC	FSD	FSE	FSF
PM230 Power Module, degree of protection IP20 and/or IP55						
Available frame sizes	✓	✓	✓	✓	✓	✓
Load-side power components						
Sine-wave filter	–	–	–	S	S	S

S = Lateral mounting

– = Not possible

Selection and ordering data

Rated power 400 V kW	460 V hp	SINAMICS G120P PM230 Power Modules degree of protection <u>IP20</u>	SINAMICS G120P PM230 Power Modules degree of protection <u>IP55/UL Type 12</u>	Frame size	Sine-wave filter
		Type 6SL3210-...	Type 6SL3223-...		Article No.
380 ... 480 V 3 AC					
22	25	1NE24-5 . L0	0DE32-2 . A0	FSD	6SL3202-0AE24-6SA0
30	30	1NE26-0 . L0	0DE33-0 . A0	FSD	6SL3202-0AE26-2SA0
37	40	1NE27-5 . L0	0DE33-7 . A0	FSE	6SL3202-0AE28-8SA0
45	50	1NE28-8 . L0	0DE34-5 . A0	FSE	
55	60	1NE31-1 . L0	0DE35-5 . A0	FSF	6SL3202-0AE31-5SA0
75	75	1NE31-5 . L0	0DE37-5 . A0	FSF	
90	100	–	0DE38-8 . A0	FSF	6SL3202-0AE31-8SA0

SINAMICS G120P built-in and wall-mounted units

PM230 Power Modules, 0.37 kW to 90 kW

Sine-wave filters

Technical specifications

Line voltage 380 ... 480 V 3 AC		Sine-wave filter			
		6SL3202-0AE24-6SA0	6SL3202-0AE26-2SA0	6SL3202-0AE28-8SA0	
Rated current	A	47	61.8	92	92
Power loss	kW	0.185	0.152	0.251	0.251
Connection to the Power Module		Screw-type terminals	Screw-type terminals	Screw-type terminals	Screw-type terminals
• Conductor cross-section	mm ²	50	50	95	95
Motor connection		Screw-type terminals	Screw-type terminals	Screw-type terminals	Screw-type terminals
• Conductor cross-section	mm ²	50	50	95	95
PE connection		M6 screw	M6 screw	M8 screw	M8 screw
Cable length, max. between sine-wave filter and motor					
• 380 ... 480 V ±10 % 3 AC					
- Shielded	m (ft)	200 (656)	200 (656)	200 (656)	200 (656)
- Unshielded	m (ft)	300 (984)	300 (984)	300 (984)	300 (984)
Dimensions					
• Width	mm (in)	250 (9.84)	250 (9.84)	275 (10.8)	275 (10.8)
• Height	mm (in)	315 (12.4)	305 (12.0)	368 (14.5)	368 (14.5)
• Depth	mm (in)	262 (10.3)	262 (10.3)	275 (10.8)	275 (10.8)
Possible as base component		No	No	No	No
Degree of protection		IP00	IP00	IP00	IP00
Weight, approx.	kg (lb)	24 (52.9)	34 (75.0)	45 (99.2)	45 (99.2)
Suitable for PM230 Power Module degree of protection IP20	Type	6SL3210-1NE24-5UL0 6SL3210-1NE24-5AL0	6SL3210-1NE26-0UL0 6SL3210-1NE26-0AL0	6SL3210-1NE27-5UL0 6SL3210-1NE27-5AL0	6SL3210-1NE28-8UL0 6SL3210-1NE28-8AL0
Suitable for PM230 Power Module degree of protection IP55/UL Type 12	Type	6SL3223-0DE32-2UA0 6SL3223-0DE32-2AA0	6SL3223-0DE33-0UA0 6SL3223-0DE33-0AA0	6SL3223-0DE33-7UA0 6SL3223-0DE33-7AA0	6SL3223-0DE34-5UA0 6SL3223-0DE34-5AA0
• Rated power of the Power Module	kW	22	30	37	45
• Rated current I_{rated} of the Power Module	A	45	60	75	90
• Frame size		FSD	FSD	FSE	FSE
Line voltage 380 ... 480 V 3 AC		Sine-wave filter			
		6SL3202-0AE31-5SA0		6SL3202-0AE31-8SA0	
Rated current	A	150		182	
Power loss	kW	0.43		0.47	
Connection to the Power Module		Screw-type terminals		Screw-type terminals	
• Conductor cross-section	mm ²	150		150	
Motor connection		Screw-type terminals		Screw-type terminals	
• Conductor cross-section	mm ²	150		150	
PE connection		M8 screw		M6 screw	
PE connection		M8 screw		M8 screw	
Cable length, max. between sine-wave filter and motor					
• 380 ... 480 V ±10 % 3 AC					
- Shielded	m (ft)	200 (656)		200 (656)	
- Unshielded	m (ft)	300 (984)		300 (984)	
Dimensions					
• Width	mm (in)	350 (13.8)		350 (13.8)	
• Height	mm (in)	440 (17.3)		468 (18.4)	
• Depth	mm (in)	305 (12.0)		305 (12.0)	
Possible as base component		No		No	
Degree of protection		IP00		IP00	
Weight, approx.	kg (lb)	63 (139)		80 (176)	
Suitable for PM230 Power Module degree of protection IP20	Type	6SL3210-1NE31-1UL0 6SL3210-1NE31-1AL0		6SL3210-1NE31-5UL0 6SL3210-1NE31-5AL0	
Suitable for PM230 Power Module degree of protection IP55/UL Type 12	Type	6SL3223-0DE35-5UA0 6SL3223-0DE35-5AA0		6SL3223-0DE37-5UA0 6SL3223-0DE37-5AA0	
• Rated power of the Power Module	kW	55		75	
• Rated current I_{rated} of the Power Module	A	110		145	
• Frame size		FSF		FSF	

SINAMICS G120P built-in and wall-mounted units

PM240P-2 Power Modules, 11 kW to 132 kW

PM240P-2 Power Modules

Overview



SINAMICS G120P PM240P-2 Power Module, frame size FSD

The new PM240P-2 Power Modules are based on a new hardware platform. This permits a higher power density to be achieved. PM240P-2 Power Modules do not have an integrated braking chopper.

In addition, PM240P-2 Power Modules are also suitable for use in safety-related applications. In conjunction with an external tripping unit (e.g. SIRIUS 3SK1), the drive becomes a Safety Integrated Drive with the Safe Torque Off (STO) safety function with a maximum Safety Integrity Level of SIL3.

PM240P-2 Power Modules, frame sizes FSD to FSF, are available both with and without an integrated line filter class A in a compact design for line voltages of 380 V to 480 V 3 AC and 500 V to 690 V 3 AC. PM240P-2 Power Modules with integrated line filter class A are suitable for connection to TN supply systems. Power Modules without an integrated line filter can be connected to grounded TN/TT systems and non-grounded IT systems.

The permissible cable lengths between inverter and motor are limited (for max. permissible cable lengths, see section [Integration](#)). Longer cables can be used if output reactors are connected (see section [Load-side power components](#)).

Note:

Shield plates and shield connection kits are available. These can be used in the wiring installation for the Control Units and Power Modules to ensure that it complies with EMC guidelines. For more information, see [Shield connection kits and shield plates for Control Units and Power Modules](#) in section [Supplementary system components](#).

Integration

All PM240P-2 Power Modules have the following connections and interfaces:

- PM-IF interface to connect the Power Module to the Control Unit. The Power Module also supplies power to the Control Unit using an integrated power supply
- Motor connection using screw-type terminals or screw studs
- 2 PE/protective conductor connections
- Connection for STO via terminals on Power Module with DIP switch

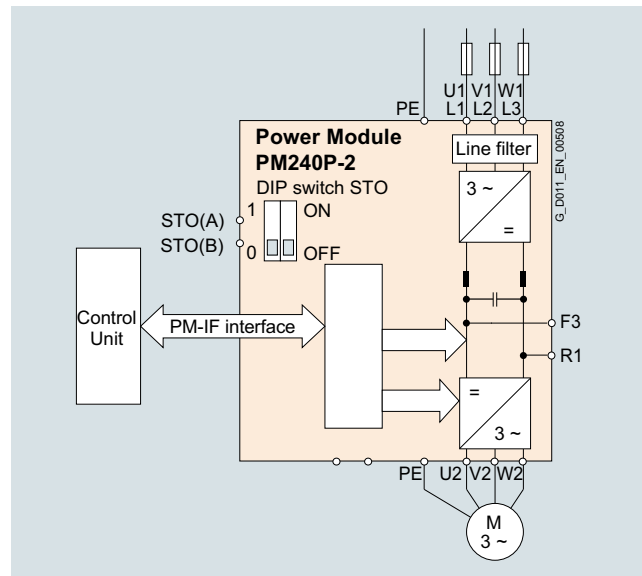

Connection diagram for PM240P-2 Power Module with or without integrated line filter class A

Available optional power components

The following load-side power components are optionally available in the appropriate frame sizes for the Power Modules:

PM240P-2 Power Module	System operating voltage	Frame size		
		FSD	FSE	FSF
Output reactor	380 ... 480 3 AC 500 ... 690 3 AC	✓ –	✓ –	✓ ✓
dv/dt filter plus VPL	500 ... 690 3 AC	✓	✓	✓

SINAMICS G120P built-in and wall-mounted units

PM240P-2 Power Modules, 11 kW to 132 kW

PM240P-2 Power Modules

Integration (continued)

Maximum permissible cable lengths from the motor to the inverter when using output reactors or dv/dt filters depending on the voltage range

The following load-side power components in the appropriate frame sizes are optionally available for the Power Modules and result in the following maximum cable lengths:

PM240P-2 Power Module, frame sizes FSD and FSE	System operating voltage	Maximum permissible motor cable lengths (shielded/unshielded) in m (ft)
Without output option	380 ... 480 V 3 AC	200/300 (656/984)
Without output option, compliance with Category C2 acc. to EN 61800-3	380 ... 480 V 3 AC	150/- (492/-)
With two output reactors in series	380 ... 480 V 3 AC	350/525 (1148/1722)
With dv/dt filter plus VPL	500 ... 690 V 3 AC	300/450 (984/1476)

PM240P-2 Power Module, frame size FSF	System operating voltage	Maximum permissible motor cable lengths (shielded/unshielded) in m (ft)
Without output option	380 ... 480 V 3 AC	300/450 (984/1476)
	500 ... 690 V 3 AC	300/450 (984/1476)
Without output option, compliance with Categories C2 and/or C3 acc. to EN 61800-3	380 ... 480 V 3 AC	150/- (Category C2)
	500 ... 690 V 3 AC	150/- (Category C3)
With two output reactors in series	380 ... 480 V 3 AC	525/800 (1722/2625)
	500 ... 690 V 3 AC	525/800 (1722/2625)
With dv/dt filter plus VPL	500 ... 690 V 3 AC	300/450 (984/1476)

Selection and ordering data

To ensure that a suitable Power Module is selected, the following currents should be used for applications:

- **Rated output current for applications with low overload (LO)**
- **Base-load current for applications with high overload (HO)**

With reference to the rated output current, the modules support at least 2-pole to 6-pole low-voltage motors, e.g. the SIMOTICS GP and SIMOTICS SD 1LE1 motor series. The rated power is merely a guide value. For a description of the overload performance, please refer to the general technical specifications of the Power Modules.

PM240P-2 Power Modules

Rated power ¹⁾		Rated output current I_{rated} ²⁾	Power based on the base-load current ³⁾		Base-load current I_H ³⁾	Frame size	PM240P-2 Power Module without integrated line filter	PM240P-2 Power Module with integrated line filter class A
400 V/ 690 V kW	460 V/ 575 V hp		400 V/ 690 V kW	460 V/ 575 V hp			Article No.	Article No.
380 ... 480 V 3 AC								
22	25	45	18.5	20	38	FSD	6SL3210-1RE24-5UL0	6SL3210-1RE24-5AL0
30	30	60	22	25	45	FSD	6SL3210-1RE26-0UL0	6SL3210-1RE26-0AL0
37	40	75	30	30	60	FSD	6SL3210-1RE27-5UL0	6SL3210-1RE27-5AL0
45	50	90	37	40	75	FSE	6SL3210-1RE28-8UL0	6SL3210-1RE28-8AL0
55	60	110	45	50	90	FSE	6SL3210-1RE31-1UL0	6SL3210-1RE31-1AL0
75	75	145	55	60	110	FSF	6SL3210-1RE31-5UL0	6SL3210-1RE31-5AL0
90	100	178	75	75	145	FSF	6SL3210-1RE31-8UL0	6SL3210-1RE31-8AL0
110	125	205	90	100	178	FSF	6SL3210-1RE32-1UL0	6SL3210-1RE32-1AL0
132	150	250	110	125	205	FSF	6SL3210-1RE32-5UL0	6SL3210-1RE32-5AL0
500 ... 690 V 3 AC								
11	10	14	7.5	8	11	FSD	6SL3210-1RH21-4UL0	6SL3210-1RH21-4AL0
15	15	19	11	10	14	FSD	6SL3210-1RH22-0UL0	6SL3210-1RH22-0AL0
18.5	20	23	15	15	19	FSD	6SL3210-1RH22-3UL0	6SL3210-1RH22-3AL0
22	25	27	18.5	20	23	FSD	6SL3210-1RH22-7UL0	6SL3210-1RH22-7AL0
30	30	35	22	25	27	FSD	6SL3210-1RH23-5UL0	6SL3210-1RH23-5AL0
37	40	42	30	30	35	FSD	6SL3210-1RH24-2UL0	6SL3210-1RH24-2AL0
45	50	52	37	40	42	FSE	6SL3210-1RH25-2UL0	6SL3210-1RH25-2AL0
55	60	62	45	50	52	FSE	6SL3210-1RH26-2UL0	6SL3210-1RH26-2AL0
75	75	80	55	60	62	FSF	6SL3210-1RH28-0UL0	6SL3210-1RH28-0AL0
90	100	100	75	75	80	FSF	6SL3210-1RH31-0UL0	6SL3210-1RH31-0AL0
110	100	115	90	100	100	FSF	6SL3210-1RH31-2UL0	6SL3210-1RH31-2AL0
132	125	142	110	100	115	FSF	6SL3210-1RH31-4UL0	6SL3210-1RH31-4AL0

Note:

The power data in hp units is based on the NEC/CEC standards for the North American market.

¹⁾ Rated power based on the rated output current I_{rated} . The rated output current I_{rated} is based on the duty cycle for low overload (LO).

²⁾ The rated output current I_{rated} is based on the duty cycle for low overload (LO). These current values are valid for 400 V or 690 V and are specified on the rating plate of the Power Module.

³⁾ The base-load current I_H is based on the duty cycle for high overload (HO).

SINAMICS G120P built-in and wall-mounted units

PM240P-2 Power Modules, 11 kW to 132 kW

PM240P-2 Power Modules

Technical specifications

General technical specifications

	PM240P-2 Power Modules
System operating voltage	380 ... 480 V 3 AC $\pm 10\%$ (in operation $-20\% < 1$ min) 500 ... 690 V 3 AC $\pm 10\%$ (in operation $-20\% < 1$ min)
Grid requirement	>25
Short-circuit power R_{SC}	
Input frequency	47 ... 63 Hz
Output frequency	
• Control mode V/f	0 ... 550 Hz
• Control type Vector	0 ... 200 Hz
Pulse frequency	
• At 380 ... 480 V 3 AC $\pm 10\%$	up to 90 kW (121 hp) (LO): 4 kHz from 110 kW (148 hp) (LO): 2 kHz Higher pulse frequencies up to 16 kHz, see derating data
• At 500 ... 690 V 3 AC $\pm 10\%$	2 kHz, can be adjusted to 4 kHz
Power factor λ	0.95 at 380 ... 480 V 3 AC 0.9 at 500 ... 690 V 3 AC
Offset factor $\cos \varphi$	0.99
Inverter efficiency	>97 % at 380 ... 480 V 3 AC >98 % at 500 ... 690 V 3 AC
Output voltage, max. As % of input voltage	95 %
Overload capability	
• Low overload (LO)	1.35 \times base-load current I_L (i.e. 135 % overload) for 3 s plus 1.1 \times base-load current I_L (i.e. 110 % overload) for 57 s within a cycle time of 300 s
<u>Note:</u> When the overload capability is used, the base-load current I_L is not reduced.	
• High overload (HO)	1.5 \times base-load current I_H (i.e. 150 % overload) for 60 s within a cycle time of 300 s
<u>Note:</u> When the overload capability is used, the base-load current I_H is not reduced.	
Electromagnetic compatibility	<ul style="list-style-type: none"> • Devices without line filter • Devices with line filter class A for compliance with conducted and radiated interference requirements of Category C2
Possible braking methods	<ul style="list-style-type: none"> • DC braking • Compound braking
Degree of protection	IP20
Operating temperature	
• Low overload (LO)	-20 ... +40 °C (-4 ... +104 °F) without derating >40 ... 60 °C (>104 ... 140 °F) see derating characteristics
• High overload (HO)	-20 ... +50 °C (-4 ... +122 °F) without derating >50 ... 60 °C (>122 ... 140 °F) see derating characteristics
Relative humidity	5 ... 95 %, condensation not permitted
Storage temperature	-25 ... +55 °C (-13 ... +131 °F)
Cooling	Internal ventilation, power units with increased air cooling by built-in fans
Installation altitude	Up to 1000 m (3281 ft) above sea level without derating, > 1000 m (3281 ft) see derating characteristics
Protection functions	<ul style="list-style-type: none"> • Undervoltage • Overvoltage • Overcurrent/overload • Overtemperature • Ground fault • Short-circuit • Stall protection • Motor blocking protection • Motor overtemperature • Inverter overtemperature • Parameter locking
Short-Circuit Current Rating SCCR (Short-Circuit Current Rating) ¹⁾	100 kA
Compliance with standards	UL, cUL, CE, RCM, SEMI F47
CE marking	According to Low Voltage Directive 2014/35/EU, EMC Directive 2014/30/EU

¹⁾ Applies to industrial control panel installations to NEC article 409 or UL 61800-5-1.

SINAMICS G120P built-in and wall-mounted units

PM240P-2 Power Modules, 11 kW to 132 kW

PM240P-2 Power Modules

Technical specifications (continued)

PM240P-2 Power Modules

Line voltage 380 ... 480 V 3 AC		PM240P-2 Power Modules				
Without integrated line filter		6SL3210-1RE24-5UL0	6SL3210-1RE26-0UL0	6SL3210-1RE27-5UL0	6SL3210-1RE28-8UL0	6SL3210-1RE31-1UL0
With integrated line filter		6SL3210-1RE24-5ALO	6SL3210-1RE26-0ALO	6SL3210-1RE27-5ALO	6SL3210-1RE28-8ALO	6SL3210-1RE31-1ALO
Output current at 50 Hz 400 V 3 AC						
• Rated current $I_{rated}^{1)}$	A	45	60	75	90	110
• Base-load current $I_L^{1)}$	A	45	60	75	90	110
• Base-load current $I_H^{2)}$	A	38	45	60	75	90
• Maximum current I_{max}	A	61	81	102	122	149
Rated power						
• Based on I_L	kW	22	30	37	45	55
• Based on I_H	kW	18.5	22	30	37	45
Rated pulse frequency		kHz	4	4	4	4
Efficiency η		%	98	98	98	98
Power loss ³⁾ at rated current						
• Without integrated line filter	kW	0.7	0.85	1.12	1.25	1.59
• With integrated line filter	kW	0.71	0.85	1.12	1.28	1.63
Cooling air requirement		m ³ /s (ft ³ /s)	0.055 (1.94)	0.055 (1.94)	0.055 (1.94)	0.083 (2.93)
Sound pressure level L_{pA} (1 m)		dB	71.6	71.6	71.6	70.6
24 V DC power supply for Control Unit		A	1	1	1	1
Rated input current $I_{rated}^{4)}$			42	57	70	86
Line supply connection U1/L1, V1/L2, W1/L3			Screw-type terminal	Screw-type terminal	Screw-type terminal	Screw-type terminal
• Conductor cross-section	mm ²	10 ... 35	10 ... 35	10 ... 35	25 ... 70	25 ... 70
Motor connection U2, V2, W2			Screw-type terminal	Screw-type terminal	Screw-type terminal	Screw-type terminal
• Conductor cross-section	mm ²	10 ... 35	10 ... 35	10 ... 35	25 ... 70	25 ... 70
Feedback connection F3, R1			Screw-type terminal	Screw-type terminal	Screw-type terminal	Screw-type terminal
• Conductor cross-section	mm ²	10 ... 35	10 ... 35	10 ... 35	25 ... 70	25 ... 70
PE connection			Screw-type terminal	Screw-type terminal	Screw-type terminal	Screw-type terminal
• Conductor cross-section	mm ²	10 ... 35	10 ... 35	10 ... 35	25 ... 70	25 ... 70
Motor cable length ⁵⁾, max.						
• Shielded	m (ft)	200 (656)	200 (656)	200 (656)	200 (656)	200 (656)
• Unshielded	m (ft)	300 (984)	300 (984)	300 (984)	300 (984)	300 (984)
Degree of protection			IP20	IP20	IP20	IP20
Dimensions						
• Width	mm (in)	200 (7.87)	200 (7.87)	200 (7.87)	275 (10.8)	275 (10.8)
• Height	mm (in)	472 (18.6)	472 (18.6)	472 (18.6)	551 (21.7)	551 (21.7)
• Depth						
- Without operator panel	mm (in)	237 (9.33)	237 (9.33)	237 (9.33)	237 (9.33)	237 (9.33)
- With Control Unit and operator panel, max.	mm (in)	274.5 (10.8)	274.5 (10.8)	274.5 (10.8)	274.5 (10.8)	274.5 (10.8)
Frame size			FSD	FSD	FSD	FSE
Weight, approx.						
• Without integrated line filter	kg (lb)	16.6 (36.6)	18.3 (40.3)	18.3 (40.3)	26 (57.3)	26 (57.3)
• With integrated line filter	kg (lb)	18.3 (40.3)	19 (41.9)	19 (41.9)	28 (61.7)	28 (61.7)

¹⁾ The rated output current I_{rated} and the base-load current I_L are based on the duty cycle for low overload (LO).

²⁾ The base-load current I_H is based on the duty cycle for high overload (HO).

³⁾ Maximum values. You can find more information on the Internet at <https://support.industry.siemens.com/cs/document/94059311>

⁴⁾ The input current depends on the motor load and line impedance. The input currents apply for a load at rated power (based on I_{rated}) for a line impedance corresponding to $u_K = 1\%$.

⁵⁾ The specified cable lengths apply to Power Modules without output option and without compliance with the limit values for RI suppression.

SINAMICS G120P built-in and wall-mounted units

PM240P-2 Power Modules, 11 kW to 132 kW

PM240P-2 Power Modules

Technical specifications (continued)

Line voltage 380 ... 480 V 3 AC		PM240P-2 Power Modules				
Without integrated line filter		6SL3210-1RE31-5ULO	6SL3210-1RE31-8ULO	6SL3210-1RE32-1ULO	6SL3210-1RE32-5ULO	
With integrated line filter		6SL3210-1RE31-5ALO	6SL3210-1RE31-8ALO	6SL3210-1RE32-1ALO	6SL3210-1RE32-5ALO	
Output current at 50 Hz 400 V 3 AC						
• Rated current $I_{rated}^{1)}$	A	145	178	205	250	
• Base-load current $I_L^{1)}$	A	145	178	205	250	
• Base-load current $I_H^{2)}$	A	110	145	178	205	
• Maximum current I_{max}	A	196	214	277	338	
Rated power						
• Based on I_L	kW	75	90	110	132	
• Based on I_H	kW	55	75	90	110	
Rated pulse frequency		kHz	4	4	2	2
Efficiency η		%	98	98	98	98
Power loss ³⁾ at rated current						
• Without integrated line filter	kW	1.58	2.07	2.28	2.97	
• With integrated line filter	kW	1.6	2.1	2.31	3.01	
Cooling air requirement		m ³ /s (ft ³ /s)	0.153 (5.40)	0.153 (5.40)	0.153 (5.40)	0.153 (5.40)
Sound pressure level L_{pA} (1 m)		dB	67.7	67.7	67.7	67.7
24 V DC power supply for Control Unit		A	1	1	1	1
Rated input current $I_{rated}^{4)}$		A	140	172	198	242
Line supply connection U1/L1, V1/L2, W1/L3			M10 screw stud	M10 screw stud	M10 screw stud	M10 screw stud
• Conductor cross-section	mm ²	35 ... 120	35 ... 120	35 ... 120	35 ... 120	
Motor connection U2, V2, W2			M10 screw stud	M10 screw stud	M10 screw stud	M10 screw stud
• Conductor cross-section	mm ²	35 ... 120	35 ... 120	35 ... 120	35 ... 120	
Feedback connection F3, R1			M10 screw stud	M10 screw stud	M10 screw stud	M10 screw stud
• Conductor cross-section	mm ²	35 ... 2 x 120	35 ... 2 x 120	35 ... 2 x 120	35 ... 2 x 120	
PE connection			M10 screw stud	M10 screw stud	M10 screw stud	M10 screw stud
• Conductor cross-section	mm ²	35 ... 120	35 ... 120	35 ... 120	35 ... 120	
Motor cable length ⁵⁾, max.						
• Shielded	m (ft)	300 (984)	300 (984)	300 (984)	300 (984)	
• Unshielded	m (ft)	450 (1476)	450 (1476)	450 (1476)	450 (1476)	
Degree of protection			IP20	IP20	IP20	IP20
Dimensions						
• Width	mm (in)	305 (12.0)	305 (12.0)	305 (12.0)	305 (12.0)	
• Height	mm (in)	708 (27.9)	708 (27.9)	708 (27.9)	708 (27.9)	
• Depth						
- Without operator panel	mm (in)	357 (14.1)	357 (14.1)	357 (14.1)	357 (14.1)	
- With Control Unit and operator panel, max.	mm (in)	394.5 (15.5)	394.5 (15.5)	394.5 (15.5)	394.5 (15.5)	
Frame size			FSF	FSF	FSF	FSF
Weight, approx.						
• Without integrated line filter	kg (lb)	57 (126)	57 (126)	61 (134)	61 (134)	
• With integrated line filter	kg (lb)	63 (139)	63 (139)	65 (143)	65 (143)	

¹⁾ The rated output current I_{rated} and the base-load current I_L are based on the duty cycle for low overload (LO).

²⁾ The base-load current I_H is based on the duty cycle for high overload (HO).

³⁾ Maximum values. You can find more information on the Internet at <https://support.industry.siemens.com/cs/document/94059311>

⁴⁾ The input current depends on the motor load and line impedance. The input currents apply for a load at rated power (based on I_{rated}) for a line impedance corresponding to $u_K = 1\%$.

⁵⁾ The specified cable lengths apply to Power Modules without output option and without compliance with the limit values for RI suppression.

SINAMICS G120P built-in and wall-mounted units

PM240P-2 Power Modules, 11 kW to 132 kW

PM240P-2 Power Modules

Technical specifications (continued)

Line voltage 500 ... 690 V 3 AC		PM240P-2 Power Modules					
Without integrated line filter		6SL3210-1RH21-4UL0	6SL3210-1RH22-0UUL0	6SL3210-1RH22-3JUL0	6SL3210-1RH22-7UL0	6SL3210-1RH23-5UL0	6SL3210-1RH24-2UL0
With integrated line filter		6SL3210-1RH21-4AL0	6SL3210-1RH22-0AL0	6SL3210-1RH22-3AL0	6SL3210-1RH22-7AL0	6SL3210-1RH23-5AL0	6SL3210-1RH24-2AL0
Output current at 50 Hz 690 V 3 AC							
• Rated current $I_{rated}^{1)}$	A	14	19	23	27	35	42
• Base-load current $I_L^{1)}$	A	14	19	23	27	35	42
• Base-load current $I_H^{2)}$	A	11	14	19	23	27	35
• Maximum current I_{max}	A	19	26	32	37	48	57
Rated power							
• Based on I_L	kW	11	15	18.5	22	30	37
• Based on I_H	kW	7.5	11	15	18.5	22	30
Rated pulse frequency							
	kHz	2	2	2	2	2	2
Efficiency η							
	%	98	98	98	98	98	98
Power loss ³⁾ at rated current							
• Without integrated line filter	kW	0.36	0.45	0.52	0.61	0.77	0.94
• With integrated line filter	kW	0.36	0.45	0.53	0.61	0.78	0.94
Cooling air requirement							
	m ³ /s (ft ³ /s)	0.055 (1.94)	0.055 (1.94)	0.055 (1.94)	0.055 (1.94)	0.055 (1.94)	0.055 (1.94)
Sound pressure level L_{pA} (1 m)							
	dB	71.6	71.6	71.6	71.6	71.6	71.6
24 V DC power supply for Control Unit							
	A	1	1	1	1	1	1
Rated input current $I_{rated}^{4)}$							
	A	14	18	22	25	33	40
Line supply connection U1/L1, V1/L2, W1/L3							
• Conductor cross-section	mm ²	10 ... 35	10 ... 35	10 ... 35	10 ... 35	10 ... 35	10 ... 35
Motor connection U2, V2, W2							
• Conductor cross-section	mm ²	10 ... 35	10 ... 35	10 ... 35	10 ... 35	10 ... 35	10 ... 35
Feedback connection F3, R1							
• Conductor cross-section	mm ²	10 ... 35	10 ... 35	10 ... 35	10 ... 35	10 ... 35	10 ... 35
PE connection							
• Conductor cross-section	mm ²	10 ... 35	10 ... 35	10 ... 35	10 ... 35	10 ... 35	10 ... 35
Motor cable length ⁵⁾, max.							
• Shielded	m (ft)	200 (656)	200 (656)	200 (656)	200 (656)	200 (656)	200 (656)
• Unshielded	m (ft)	300 (984)	300 (984)	300 (984)	300 (984)	300 (984)	300 (984)
Degree of protection							
		IP20	IP20	IP20	IP20	IP20	IP20
Dimensions							
• Width	mm (in)	200 (7.87)	200 (7.87)	200 (7.87)	200 (7.87)	200 (7.87)	200 (7.87)
• Height	mm (in)	472 (18.6)	472 (18.6)	472 (18.6)	472 (18.6)	472 (18.6)	472 (18.6)
• Depth							
- Without operator panel	mm (in)	237 (9.33)	237 (9.33)	237 (9.33)	237 (9.33)	237 (9.33)	237 (9.33)
- With Control Unit and operator panel, max.	mm (in)	274.5 (10.8)	274.5 (10.8)	274.5 (10.8)	274.5 (10.8)	274.5 (10.8)	274.5 (10.8)
Frame size							
		FSD	FSD	FSD	FSD	FSD	FSD
Weight, approx.							
• Without integrated line filter	kg (lb)	17.4 (38.4)	17.4 (38.4)	17.4 (38.4)	17.4 (38.4)	17.4 (38.4)	17.4 (38.4)
• With integrated line filter	kg (lb)	18.9 (41.7)	18.9 (41.7)	18.9 (41.7)	18.9 (41.7)	18.9 (41.7)	18.9 (41.7)

¹⁾ The rated output current I_{rated} and the base-load current I_L are based on the duty cycle for low overload (LO).

²⁾ The base-load current I_H is based on the duty cycle for high overload (HO).

³⁾ Maximum values. You can find more information on the Internet at <https://support.industry.siemens.com/cs/document/94059311>

⁴⁾ The input current depends on the motor load and line impedance. The input currents apply for a load at rated power (based on I_{rated}) for a line impedance corresponding to $u_K = 1\%$.

⁵⁾ The specified cable lengths apply to Power Modules without output option and without compliance with the limit values for RI suppression.

SINAMICS G120P built-in and wall-mounted units

PM240P-2 Power Modules, 11 kW to 132 kW

PM240P-2 Power Modules

Technical specifications (continued)

Line voltage 500 ... 690 V 3 AC		PM240P-2 Power Modules					
Without integrated line filter		6SL3210-1RH25-2UL0	6SL3210-1RH26-2UL0	6SL3210-1RH28-0UL0	6SL3210-1RH31-0UL0	6SL3210-1RH31-2UL0	6SL3210-1RH31-4UL0
With integrated line filter		6SL3210-1RH25-2AL0	6SL3210-1RH26-2AL0	6SL3210-1RH28-0AL0	6SL3210-1RH31-0AL0	6SL3210-1RH31-2AL0	6SL3210-1RH31-4AL0
Output current at 50 Hz 690 V 3 AC							
• Rated current $I_{rated}^{1)}$	A	52	62	80	100	115	142
• Base-load current $I_L^{1)}$	A	52	62	80	100	115	142
• Base-load current $I_H^{2)}$	A	42	52	62	80	100	115
• Maximum current I_{max}	A	71	84	108	135	156	192
Rated power							
• Based on I_L	kW	45	55	75	90	110	132
• Based on I_H	kW	37	45	55	75	90	110
Rated pulse frequency		kHz	2	2	2	2	2
Efficiency η		%	99	99	99	99	99
Power loss ³⁾ at rated current							
• Without integrated line filter	kW	1.08	1.3	1.37	1.75	1.95	2.49
• With integrated line filter	kW	1.09	1.31	1.38	1.76	1.97	2.51
Cooling air requirement		m ³ /s (ft ³ /s)	0.055 (1.94)	0.055 (1.94)	0.055 (1.94)	0.055 (1.94)	0.055 (1.94)
Sound pressure level L_{pA} (1 m)		dB	70.6	70.6	67.7	67.7	67.7
24 V DC power supply for Control Unit		A	1	1	1	1	1
Rated input current $I_{rated}^{4)}$		A	50	59	78	97	111
Line supply connection U1/L1, V1/L2, W1/L3			Screw-type terminal	Screw-type terminal	M10 screw stud	M10 screw stud	M10 screw stud
• Conductor cross-section	mm ²	25 ... 70	25 ... 70	35 ... 120	35 ... 120	35 ... 120	35 ... 120
Motor connection U2, V2, W2			Screw-type terminal	Screw-type terminal	M10 screw stud	M10 screw stud	M10 screw stud
• Conductor cross-section	mm ²	25 ... 70	25 ... 70	35 ... 120	35 ... 120	35 ... 120	35 ... 120
Feedback connection F3, R1			Screw-type terminal	Screw-type terminal	M10 screw stud	M10 screw stud	M10 screw stud
• Conductor cross-section	mm ²	25 ... 70	25 ... 70	35 ... 2 x 120	35 ... 2 x 120	35 ... 2 x 120	35 ... 2 x 120
PE connection			Screw-type terminal	Screw-type terminal	M10 screw stud	M10 screw stud	M10 screw stud
• Conductor cross-section	mm ²	25 ... 70	25 ... 70	35 ... 120	35 ... 120	35 ... 120	35 ... 120
Motor cable length ⁵⁾, max.							
• Shielded	m (ft)	200 (656)	200 (656)	300 (984)	300 (984)	300 (984)	300 (984)
• Unshielded	m (ft)	300 (984)	300 (984)	450 (1476)	450 (1476)	450 (1476)	450 (1476)
Degree of protection			IP20	IP20	IP20	IP20	IP20
Dimensions							
• Width	mm (in)	275 (10.8)	275 (10.8)	305 (12.0)	305 (12.0)	305 (12.0)	305 (12.0)
• Height	mm (in)	551 (21.7)	551 (21.7)	708 (27.9)	708 (27.9)	708 (27.9)	708 (27.9)
• Depth							
- Without operator panel	mm (in)	237 (9.33)	237 (9.33)	357 (14.1)	357 (14.1)	357 (14.1)	357 (14.1)
- With Control Unit and operator panel, max.	mm (in)	274.5 (10.8)	274.5 (10.8)	394.5 (15.5)	394.5 (15.5)	394.5 (15.5)	394.5 (15.5)
Frame size			FSE	FSE	FSF	FSF	FSF
Weight, approx.							
• Without integrated line filter	kg (lb)	26 (57.3)	26 (57.3)	60 (132)	60 (132)	60 (132)	60 (132)
• With integrated line filter	kg (lb)	28 (61.7)	28 (61.7)	64 (141)	64 (141)	64 (141)	64 (141)

¹⁾ The rated output current I_{rated} and the base-load current I_L are based on the duty cycle for low overload (LO).

²⁾ The base-load current I_H is based on the duty cycle for high overload (HO).

³⁾ Maximum values. You can find more information on the Internet at <https://support.industry.siemens.com/cs/document/94059311>

⁴⁾ The input current depends on the motor load and line impedance. The input currents apply for rated power loading (based on I_{rated}) for a line impedance corresponding to $u_K = 1\%$.

⁵⁾ The specified cable lengths apply to Power Modules without output option and without compliance with the limit values for RI suppression.

SINAMICS G120P built-in and wall-mounted units

PM240P-2 Power Modules, 11 kW to 132 kW

PM240P-2 Power Modules

Characteristic curves

Derating data

Current derating as a function of the pulse frequency

Rated power 400 V		Rated output current in A for a pulse frequency of							
kW	460 V hp	2 kHz	4 kHz	6 kHz	8 kHz	10 kHz	12 kHz	14 kHz	16 kHz
22	25	45	45	38.3	31.5	27	22.5	20.3	18
30	30	60	60	51	42	36	30	27	24
37	40	75	75	63.8	52.5	45	37.5	33.8	30
45	50	90	90	76.5	63	54	45	40.5	36
55	60	110	110	93.5	77	66	55	49.5	44
75	75	145 ¹⁾	145	123.3	101.5	–	–	–	–
90	100	178 ¹⁾	178	151.3	124.6	–	–	–	–
110	125	205 ¹⁾	143.5	–	–	–	–	–	–
132	150	250 ¹⁾	175	–	–	–	–	–	–

Rated power 690 V		Rated output current in A for a pulse frequency of	
kW	575 V hp	2 kHz	4 kHz
11	10	14	8.4
15	15	19	11.4
18.5	20	23	13.8
22	25	27	16.2
30	30	35	21
37	40	42	25.2
45	50	52	31.2
55	60	62	37.2
75	75	80	48
90	100	100	60
110	100	115	69
132	125	142	85.2

¹⁾ For these Power Modules, the factory default pulse frequency setting is 2 kHz. If switched over to 4 kHz, the RFI suppression limit values for Category C3 are complied with.

SINAMICS G120P built-in and wall-mounted units

PM240P-2 Power Modules, 11 kW to 132 kW

PM240P-2 Power Modules

Characteristic curves (continued)

Current derating as a function of the ambient temperature

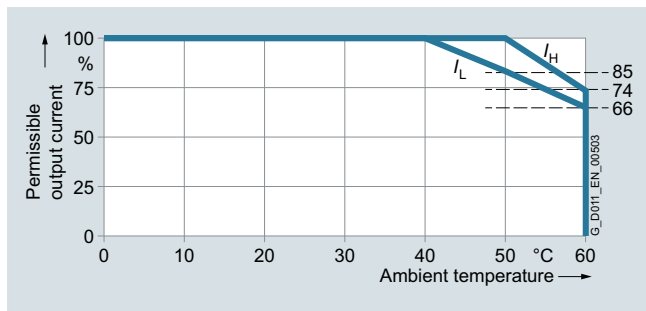

Permissible output current as a function of the ambient temperature for low overload (LO) and high overload (HO)

Note:

The operating temperature ranges of the Control Units should be taken into account. The temperature ranges are specified in the section Technical specifications under Control Units.

Current derating as a function of the installation altitude

Permissible line supplies as a function of the installation altitude

- Installation altitude up to 2000 m (6562 ft) above sea level
 - Connection to every supply system permitted for the inverter
- Installation altitudes between 2000 m (6562 ft) and 4000 m (13124 ft) above sea level
 - Connection to a TN system with grounded neutral point
 - TN systems with grounded line conductor are not permitted
 - The TN line system with grounded neutral point can also be supplied using an isolation transformer
 - The phase-to-phase voltage does not have to be reduced

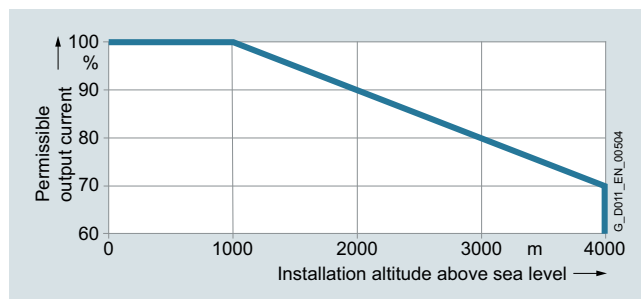

Permissible output current as a function of the installation altitude

Note:

The connected motors, power elements and components must be considered separately.

Current derating as a function of the installation altitude and the ambient temperature

At installation altitudes above 1000 m (3281 ft), the permissible output current can be compensated to a certain extent using the ambient temperature.

Installation altitude above sea level m (ft)	Current derating factor (in % of the base-load output current I_L) at an ambient temperature of												
	0 °C (32 °F)	5 °C (41 °F)	10 °C (50 °F)	15 °C (59 °F)	20 °C (68 °F)	25 °C (77 °F)	30 °C (86 °F)	35 °C (95 °F)	40 °C (104 °F)	45 °C (113 °F)	50 °C (122 °F)	55 °C (131 °F)	60 °C (140 °F)
0 ... 1000 (0 ... 3281)										93 %	85 %	76 %	66 %
1000 ... 1500 (3281 ... 4921)									95 %	88 %	81 %	72 %	63 %
1500 ... 2000 (4921 ... 6562)				100 %				97 %	90 %	83 %	77 %	68 %	59 %
2000 ... 2500 (6562 ... 8202)							98 %	91 %	85 %	79 %	72 %	64 %	56 %
2500 ... 3000 (8202 ... 9843)						98 %	92 %	86 %	80 %	74 %	68 %	60 %	53 %
3000 ... 3500 (9843 ... 11483)	98 %	98 %	98 %	98 %	98 %	92 %	86 %	81 %	75 %	69 %	64 %	57 %	50 %
3500 ... 4000 (11483 ... 13123)	91 %	91 %	91 %	91 %	91 %	86 %	81 %	75 %	70 %	65 %	60 %	53 %	46 %

Installation altitude above sea level m (ft)	Current derating factor (in % of the base-load output current I_H) at an ambient temperature of												
	0 °C (32 °F)	5 °C (41 °F)	10 °C (50 °F)	15 °C (59 °F)	20 °C (68 °F)	25 °C (77 °F)	30 °C (86 °F)	35 °C (95 °F)	40 °C (104 °F)	45 °C (113 °F)	50 °C (122 °F)	55 °C (131 °F)	60 °C (140 °F)
0 ... 1000 (0 ... 3281)												87 %	74 %
1000 ... 1500 (3281 ... 4921)											95 %	83 %	70 %
1500 ... 2000 (4921 ... 6562)				100 %					99 %	95 %	90 %	78 %	67 %
2000 ... 2500 (6562 ... 8202)								98 %	94 %	89 %	85 %	74 %	63 %
2500 ... 3000 (8202 ... 9843)							96 %	92 %	88 %	84 %	80 %	70 %	59 %
3000 ... 3500 (9843 ... 11483)	98 %	98 %	98 %	98 %	98 %	94 %	90 %	86 %	83 %	79 %	75 %	65 %	56 %
3500 ... 4000 (11483 ... 13123)	91 %	91 %	91 %	91 %	91 %	88 %	84 %	81 %	77 %	74 %	70 %	61 %	52 %

Characteristic curves (continued)

Current/power derating as a function of the line voltage

PM240P-2 Power Modules supply a constant power in the line voltage range 380 V to 480 V 3 AC. The constant power results in current derating as a function of the line voltage.

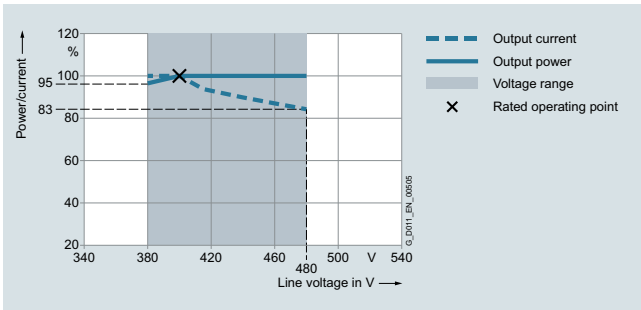

PM240P-2 Power Modules supply a constant output current in the line voltage range 500 V to 690 V 3 AC. Output power derating takes place as a function of the line voltage.

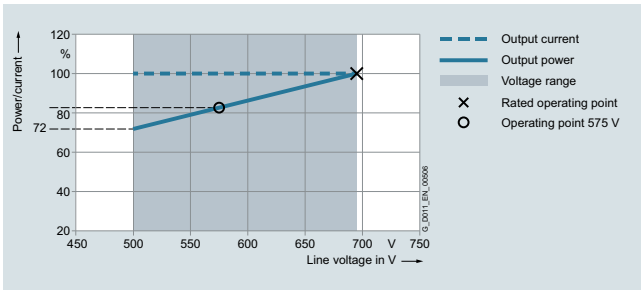

Overload capability

The Power Modules are equipped with an overload reserve e.g. to handle breakaway torques. If larger surge loads occur, this must be taken into account in the configuration. For drives with overload requirements, the appropriate base-load current must, therefore, be used as a basis for the required load.

The units can operate in two different duty cycles in the permissible continuous operating range. Depending on how the system is dimensioned, the relevant base-load current is effective as a rated quantity.

The criterion for overload is that the inverter is operated with its base-load current before and after the overload occurs on the basis of a duty cycle duration of 300 s.

The base-load current I_L for low overload is the basis for a duty cycle of 135 % for 3 s plus 110 % for 57 s.

The base-load current I_H for high overload is based on a duty cycle of 150 % for 60 s.

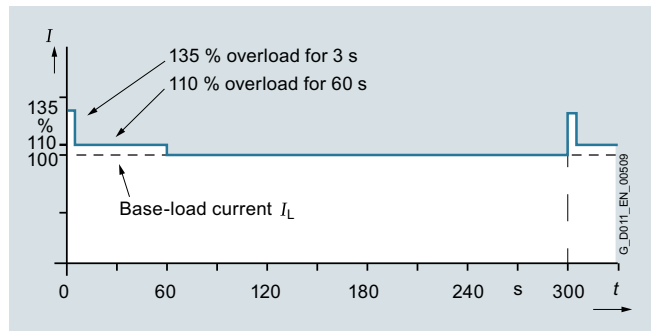

Overload capability, low overload

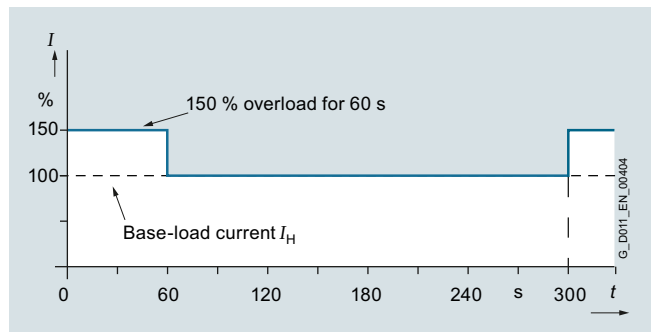

Overload capability, high overload



SINAMICS G120P built-in and wall-mounted units

PM240P-2 Power Modules, 11 kW to 132 kW

PM240P-2 Power Modules

Dimensional drawings

PM240P-2 Power Modules

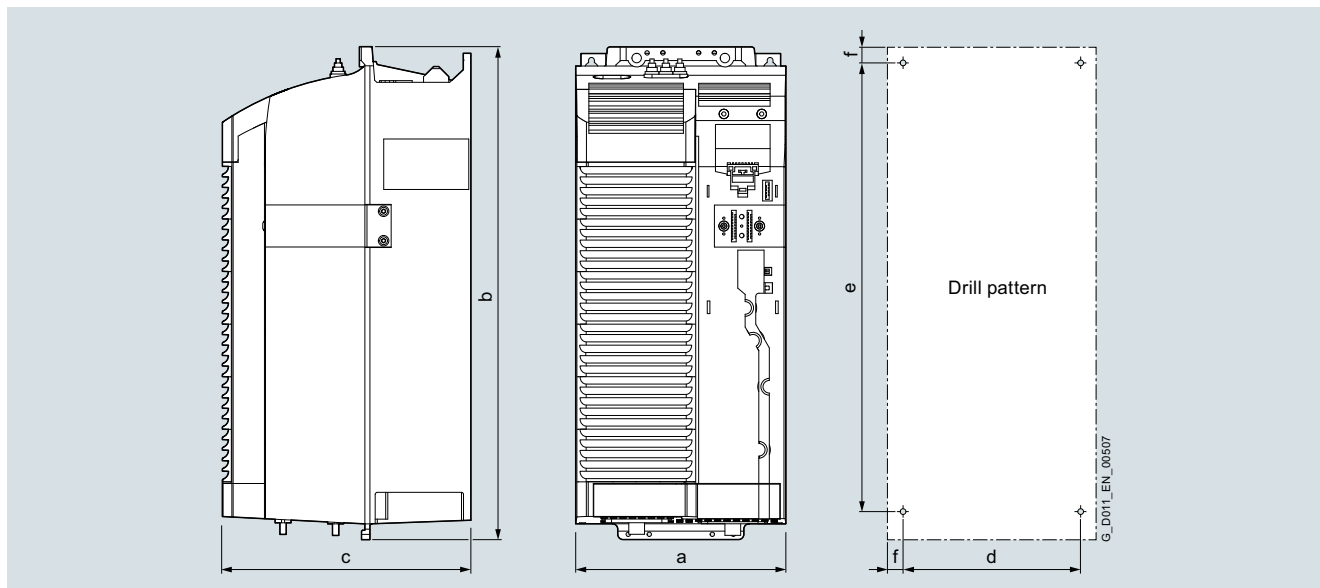

Principle dimension drawing and drill pattern for PM240P-2 Power Module

Frame size	Dimensions in mm (inches)			Drilling dimensions in mm (inches)			Cooling clearance in mm (inches)			Mounting With bolts
	a (width)	b (height)	c (depth) ¹⁾	d	e	f	Top	Bottom	Front	
PM240P-2 Power Modules										
FSD	200 (7.87)	472 (18.58)	237 (9.33)	170 (6.69)	430 (16.93)	15 (0.59)	300 (11.81)	350 (13.78)	100 (3.94)	4 × M5
FSE	275 (10.83)	551 (21.69)	237 (9.33)	230 (9.06)	509 (20.04)	11 (0.43)	300 (11.81)	350 (13.78)	100 (3.94)	4 × M6
FSF	305 (12.01)	708 (27.87)	357 (14.06)	270 (10.63)	680 (26.77)	13 (0.51)	300 (11.81)	350 (13.78)	100 (3.94)	4 × M8

¹⁾ Increase in Power Module mounting depth:

- When the CU230P-2 Control Unit is plugged on, the depth increases by 15.5 mm (0.61 in)
- When the IOP-2/BOP-2 is plugged on, the depth increases by a further 11 mm (0.43 in)

SINAMICS G120P built-in and wall-mounted units

PM240P-2 Power Modules, 11 kW to 132 kW

Recommended line-side overcurrent protection devices

Selection and ordering data

Overcurrent protection devices are absolutely necessary for the operation of the inverters. The following tables list recommendations for fuses.

Recommended fuses:

- Siemens fuses of type 3NA3 for use in the area of validity of IEC
- UL-listed fuses Class J for use in USA and Canada

Recommendations on further overcurrent protection devices are available at:

<https://support.industry.siemens.com/cs/document/109750825>

The Short-Circuit Current Rating (SCCR) according to UL for industrial control panel installations to NEC article 409 or UL 61800-5-1 is as follows for Class J fuses for

- PM240P-2: 100 kA

SCCR and ICC values for combination with further overcurrent protection devices are available at:

<https://support.industry.siemens.com/cs/document/109750825>

Notes regarding installations in Canada:

The inverters are intended for line supply systems with overvoltage category III. More information is available in the technical documentation on the Internet at:

www.siemens.com/sinamics-g120p/documentation

Additional information about the listed Siemens fuses and circuit breakers is available in Catalogs LV 10, IC 10 and IC 10 AO as well as in the Industry Mall.

Rated power ¹⁾		SINAMICS G120 PM240P-2 Power Modules		IEC-compliant		UL/cUL-compliant		
400 V/690 V kW	460 V/575 V hp	Type 6SL3210-...	Frame size	Current A	Type 3NA3 Article No.	Fuse Type 3NE1 (UL) Article No.	Fuse type Rated voltage 600 V AC Class	Current A
380 ... 480 V 3 AC								
22	25	1RE24-5 . L0	FSD	80	3NA3824	3NE1820-0	J	70
30	30	1RE26-0 . L0	FSD	100	3NA3830	3NE1021-0	J	90
37	40	1RE27-5 . L0	FSD	100	3NA3830	3NE1021-0	J	100
45	50	1RE28-8 . L0	FSE	125	3NA3832	3NE1022-0	J	125
55	60	1RE31-1 . L0	FSE	160	3NA3836	3NE1224-0	J	150
75	75	1RE31-5 . L0	FSF	200	3NA3140	3NE1225-0	J	200
90	100	1RE31-8 . L0	FSF	224	3NA3142	3NE1227-0	J	225
110	125	1RE32-1 . L0	FSF	300	3NA3250	3NE1230-0	J	300
132	150	1RE32-5 . L0	FSF	315	3NA3252	3NE1331-0	J	350
500 ... 690 V 3 AC								
11	10	1RH21-4 . L0	FSD	50	3NA3120-6	3NE1815-0	J	20
15	15	1RH22-0 . L0	FSD	50	3NA3120-6	3NE1815-0	J	25
18.5	20	1RH22-3 . L0	FSD	50	3NA3120-6	3NE1803-0	J	30
22	25	1RH22-7 . L0	FSD	50	3NA3120-6	3NE1803-0	J	35
30	30	1RH23-5 . L0	FSD	50	3NA3120-6	3NE1817-0	J	45
37	40	1RH24-2 . L0	FSD	63	3NA3122-6	3NE1818-0	J	60
45	50	1RH25-2 . L0	FSE	80	3NA3124-6	3NE1820-0	J	80
55	60	1RH26-2 . L0	FSE	80	3NA3124-6	3NE1820-0	J	80
75	75	1RH28-0 . L0	FSF	100	3NA3130-6	3NE1021-0	J	100
90	100	1RH31-0 . L0	FSF	125	3NA3132-6	3NE1022-0	J	125
110	100	1RH31-2 . L0	FSF	160	3NA3136-6	3NE1224-0	J	150
132	125	1RH31-4 . L0	FSF	200	3NA3140-6	3NE1225-0	J	200

¹⁾ Rated power based on the rated output current I_{rated} . The rated output current I_{rated} is based on the duty cycle for low overload (LO).

SINAMICS G120P built-in and wall-mounted units

PM240P-2 Power Modules, 11 kW to 132 kW

Output reactors

Overview

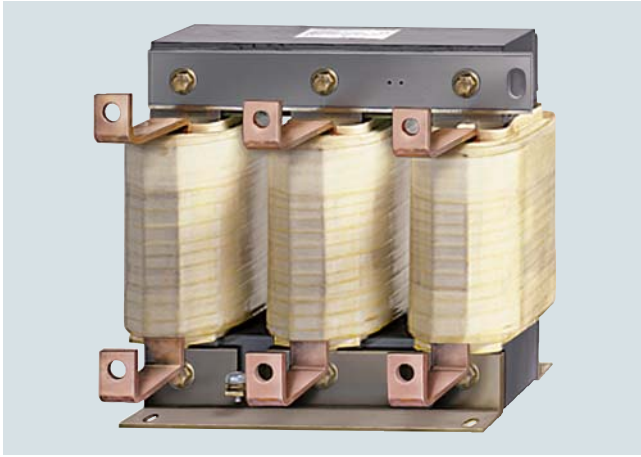

Output reactor

Output reactors reduce the rate of voltage rise (dv/dt) and the height of the current peaks, and enable longer motor cables to be connected.

Owing to the high rates of voltage rise of the fast-switching IGBTs, the capacitance of long motor cables reverses polarity very quickly with every switching operation in the inverter. As a result, the inverter is loaded with additional current peaks of substantial magnitude.

Output reactors reduce the magnitude of these additional peaks because the cable capacitance reverses polarity more slowly across the reactor inductance, thereby attenuating the amplitudes of the current peaks.

When using output reactors, the following should be observed:

- Max. permissible output frequency 150 Hz
- Max. permissible pulse frequency 4 kHz
- The output reactor must be installed as close as possible to the Power Module

Two output reactors are to be provided to increase the permissible cable lengths.

When connecting the Power Modules to IT networks, the use of an output reactor is recommended to avoid an overcurrent shut-down in the event of a ground fault.

4

Integration

Available optional output reactors

	Frame size		
	FSD	FSE	FSF
PM240P-2 Power Module			
Available output reactors			
• 400 V versions	✓	✓	✓
• 690 V versions	–	–	✓

Selection and ordering data

Rated power		SINAMICS G120P, PM240P-2 Power Modules		Output reactor
400 V/690 V	460 V/575 V	Type 6SL3210-...	Frame size	Article No.
kW	hp			
380 ... 480 V 3 AC				
22	25	1RE24-5 . L0	FSD	6SE6400-3TC07-5ED0
30	30	1RE26-0 . L0	FSD	
37	40	1RE27-5 . L0	FSD	
45	50	1RE28-8 . L0	FSE	6SE6400-3TC14-5FD0
55	60	1RE31-1 . L0	FSE	
75	75	1RE31-5 . L0	FSF	
90	100	1RE31-8 . L0	FSF	6SL3000-2BE32-1AA0
110	125	1RE32-1 . L0	FSF	
132	150	1RE32-5 . L0	FSF	
500 ... 690 V 3 AC				
75	75	1RH28-0 . L0	FSF	6SL3000-2AH31-0AA0
90	100	1RH31-0 . L0	FSF	
110	100	1RH31-2 . L0	FSF	6SL3000-2AH31-5AA0
132	125	1RH31-4 . L0	FSF	

SINAMICS G120P built-in and wall-mounted units

PM240P-2 Power Modules, 11 kW to 132 kW

Output reactors

Technical specifications

Line voltage 380 ... 480 V 3 AC		Output reactor			
		6SE6400-3TC07-5ED0	6SE6400-3TC14-5FDO	6SL3000-2BE32-1AA0	6SL3000-2BE32-6AA0
Rated current	A	90	178 ¹⁾	210	260
Power loss	kW	0.27	0.47	0.49	0.5
Connection to the Power Module		Flat connector for M6 screw	Flat connector for M8 screw	Flat connector for M10 screw	Flat connector for M10 screw
Motor connection		Flat connector for M6 screw	Flat connector for M8 screw	Flat connector for M10 screw	Flat connector for M10 screw
PE connection		M6 screw	M8 screw	M8 screw	M8 screw
Cable length, max. between output reactor and motor					
• Shielded	m (ft)	200 (656)	200 (656)	300 (984)	300 (984)
• Unshielded	m (ft)	300 (984)	300 (984)	450 (1476)	450 (1476)
Dimensions					
• Width	mm (in)	270 (10.6)	350 (13.8)	300 (11.8)	300 (11.8)
• Height	mm (in)	248 (9.76)	321 (12.6)	285 (11.2)	315 (12.4)
• Depth	mm (in)	209 (8.23)	288 (11.3)	257 (10.1)	277 (10.9)
Degree of protection		IP20	IP20	IP00	IP00
Weight, approx.	kg (lb)	27 (59.5)	57 (126)	60 (132)	66 (146)
Suitable for PM240P-2 Power Modules	Type	6SL3210-1RE24-5 . LO 6SL3210-1RE26-0 . LO 6SL3210-1RE27-5 . LO	FSE: 6SL3210-1RE28-8 . LO 6SL3210-1RE31-1 . LO FSF: 6SL3210-1RE31-5 . LO 6SL3210-1RE31-8 . LO	6SL3210-1RE32-1 . LO	6SL3210-1RE32-5 . LO
• Frame size		FSD	FSE/FSF	FSF	FSF
Line voltage 500 ... 690 V 3 AC		Output reactor			
		6SL3000-2AH31-0AA0		6SL3000-2AH31-5AH0	
Rated current	A	100		150	
Power loss	kW	0.3		0.34	
Connection to the Power Module		Flat connector for M10 screw		Flat connector for M10 screw	
Motor connection		Flat connector for M10 screw		Flat connector for M10 screw	
PE connection		M6 screw		M6 screw	
Cable length, max. between output reactor and motor					
• Shielded	m (ft)	300 (984)		300 (984)	
• Unshielded	m (ft)	450 (1476)		450 (1476)	
Dimensions					
• Width	mm (in)	270 (10.6)		270 (10.6)	
• Height	mm (in)	248 (9.76)		248 (9.76)	
• Depth	mm (in)	200 (7.87)		200 (7.87)	
Degree of protection		IP00		IP00	
Weight, approx.	kg (lb)	25 (55.1)		25.8 (56.9)	
Suitable for PM240P-2 Power Modules	Type	6SL3210-1RH28-0 . LO 6SL3210-1RH31-0 . LO		6SL3210-1RH31-2 . LO 6SL3210-1RH31-4 . LO	
• Frame size		FSF		FSF	

¹⁾ On the rating plate of the reactor, the current is specified according to the duty cycle for high overload (HO). This is lower than the current specified according to the duty cycle for low overload (LO) of the Power Module.

SINAMICS G120P built-in and wall-mounted units

PM240P-2 Power Modules, 11 kW to 132 kW

dv/dt filters plus VPL

Overview



dv/dt filter plus VPL (**V**oltage **P**eak **L**imiter) limit the voltage rate-of-rise dv/dt to values $< 500 \text{ V}/\mu\text{s}$ and the typical voltage peaks to the following values according to the limit value curve to IEC/TS 60034-17: 2006:

- $< 1000 \text{ V}$ at $U_{\text{line}} < 575 \text{ V}$
- $< 1250 \text{ V}$ at $660 \text{ V} < U_{\text{line}} < 690 \text{ V}$

Standard motors with standard insulation and without insulated bearings can be used for inverter operation if a dv/dt filter plus VPL is used.

The dv/dt filter plus VPL are designed for the following maximum motor cable lengths:

- Shielded cables: 300 m (984 ft) (e.g. Protodur NYCWY)
- Unshielded cables: 450 m (1476 ft) (e.g. Protodur NYY)

For shorter cable lengths (100 m (328 ft) shielded, 150 m (492 ft) unshielded) also refer to dv/dt filter compact plus VPL.

Note:

The maximum permissible cable length between the dv/dt filter and Power Module is 5 m (16.4 ft).

Design

In terms of function, the dv/dt filter plus VPL consists of two components:

- dv/dt reactor
- Voltage limiting network, which cuts off the voltage peaks and feeds the energy back into the DC link.

Selection and ordering data

Rated power		SINAMICS G120P, PM240P-2 Power Module		dv/dt filter plus VPL
690 V	575 V	Type 6SL3210-...	Frame size	Article No.
kW	hp			
500 ... 690 V 3 AC				
11	10	1RH21-4 . L0	FSD	6SL3000-2DH31-0AA0
15	15	1RH22-0 . L0	FSD	
18.5	20	1RH22-3 . L0	FSD	
22	25	1RH22-7 . L0	FSD	
30	30	1RH23-5 . L0	FSD	
37	40	1RH24-2 . L0	FSD	
45	50	1RH25-2 . L0	FSE	
55	60	1RH26-2 . L0	FSE	
75	75	1RH28-0 . L0	FSF	
90	100	1RH31-0 . L0	FSF	
110	100	1RH31-2 . L0	FSF	
132	125	1RH31-4 . L0	FSF	

SINAMICS G120P built-in and wall-mounted units

PM240P-2 Power Modules, 11 kW to 132 kW

dv/dt filters plus VPL

Technical specifications

Line voltage 500 ... 690 V 3 AC		dv/dt filter plus VPL	
		6SL3000-2DH31-0AA0	6SL3000-2DH31-5AA0
$I_{th\ max}$	A	100	150
Degree of protection		IP00	IP00
Cable length, max. between dv/dt filter and motor			
• Shielded	m (ft)	300 (984)	300 (984)
• Unshielded	m (ft)	450 (1476)	450 (1476)
Conformity		CE	CE
Certificates of suitability, according to		cURus	cURus
dv/dt reactor			
Power loss, max.			
• At 50 Hz 500/690 V	kW	0.49	0.389
• At 60 Hz 575 V	kW	0.508	0.408
• At 150 Hz 500/690 V	kW	0.541	0.436
Connections			
• To Power Module		1 × hole for M10	1 × hole for M10
• To load		1 × hole for M10	1 × hole for M10
• PE		M6 screw	M6 screw
Dimensions			
• Width	mm (in)	350 (13.8)	350 (13.8)
• Height	mm (in)	320 (12.6)	320 (12.6)
• Depth	mm (in)	227 (8.94)	227 (8.94)
Weight, approx.	kg (lb)	48 (106)	50 (110)
Voltage Peak Limiter (VPL)			
Power loss, max.			
• At 50 Hz 500/690 V	kW	0.016	0.02
• At 60 Hz 575 V	kW	0.015	0.019
• At 150 Hz 500/690 V	kW	0.013	0.018
Connections			
• To dv/dt reactor		M8 nut	M8 nut
• To DC link		M8 nut	M8 nut
• PE		M8 stud	M8 stud
Dimensions			
• Width	mm (in)	263 (10.4)	263 (10.4)
• Height	mm (in)	265 (10.4)	265 (10.4)
• Depth	mm (in)	188 (7.40)	188 (7.40)
Weight, approx.	kg (lb)	6 (13.2)	6 (13.2)
Suitable for PM240P-2 Power Modules		FSD: 6SL3210-1RH21-4 . L0 6SL3210-1RH22-0 . L0 6SL3210-1RH22-3 . L0 6SL3210-1RH22-7 . L0 6SL3210-1RH23-5 . L0 6SL3210-1RH24-2 . L0 FSE: 6SL3210-1RH25-2 . L0 6SL3210-1RH26-2 . L0 FSF: 6SL3210-1RH28-0 . L0 6SL3210-1RH31-0 . L0	6SL3210-1RH31-2 . L0 6SL3210-1RH31-4 . L0
• Frame size		FSD/FSE/FSF	FSF

SINAMICS G120P built-in and wall-mounted units

PM330 Power Modules, 160 kW to 630 kW

PM330 Power Modules

Overview



PM330 Power Module, degree of protection IP20, frame size GX

PM330 Power Modules have been specially developed for simple applications, such as driving pumps, fans and compressors with speed-controlled increasing load characteristics.

PM330 Power Modules meet the very high energy efficiency requirements particularly well, especially in this area of application, because they offer the best possible energy utilization in all operating ranges. This is achieved by the very high efficiency verified according to EN 50598, various energy-saving functions, and the automatic pulse frequency adjustment.

To reduce emissions, the PM330 Power Modules are equipped with a radio interference suppression filter as standard (in accordance with the limit values defined in Category C3). Through the use of an external line filter, the PM330 Power Modules also comply with the limits for use in the first environment (Category C2) as specified in EN 61800-3¹⁾.

If required, various high-performance dv/dt filters or a Braking Module can be connected. A corresponding DC link connection is available as standard.

All available system components are coordinated exactly with the PM330 Power Modules. This enables the implementation of reliable, safe, customized control cabinet solutions. All connections can easily be accessed from the front. The internal modules are very easily accessible.

Exceptional requirements concerning motor cable lengths can be easily implemented via output reactors. Series connections are permissible here.

The PM330 Power Modules are designed for connection to grounded TN/TT systems and non-grounded IT systems. 690 V line supplies with grounded line conductor are not permitted.

The CU230P-2 Control Unit intended for PM330 Power Modules does not have special Safety Integrated functions. Safety functions can be implemented by means of external switching devices.

Integration

The PM330 Power Modules have the following connections and interfaces:

- PM-IF interface to connect the PM330 Power Module to the Control Unit. The PM330 Power Module also supplies power to the Control Unit using an integrated power supply.
- Motor connection and line supply connection via screw studs
- DC-link connection for Braking Module and dv/dt filter
- PE (protective earth) connections
- Terminal block X9
 - Input for external 24 V DC supply
 - Input for external alarm/fault
 - Input for EMERGENCY OFF / EMERGENCY STOP
 - Output for DC 24 V (Output current max. 250 mA)
 - Control of the main contactor
 - Feedback message "DC link charged"
- Terminal block X41²⁾
 - Two-channel STO control
 - Switch-off signal path feedback
 - Enabling STO via combination on switch S41

PM330 Power Modules communicate with the Control Unit via the PM-IF interface.

For the STO and SS1 safety functions, we recommend the use of SIRIUS 3SK1 safety relays with relay outputs and 24 V supply voltage. The safety relays can be directly supplied with voltage by the Power Module. This enables the very simple implementation of the STO safety function.

- STO: 3SK1111-2AB30
- SS1: 3SK1121-2CB42

For further information, refer to the [SINAMICS G120P Power Modules PM330 Hardware Installation Manual](#).

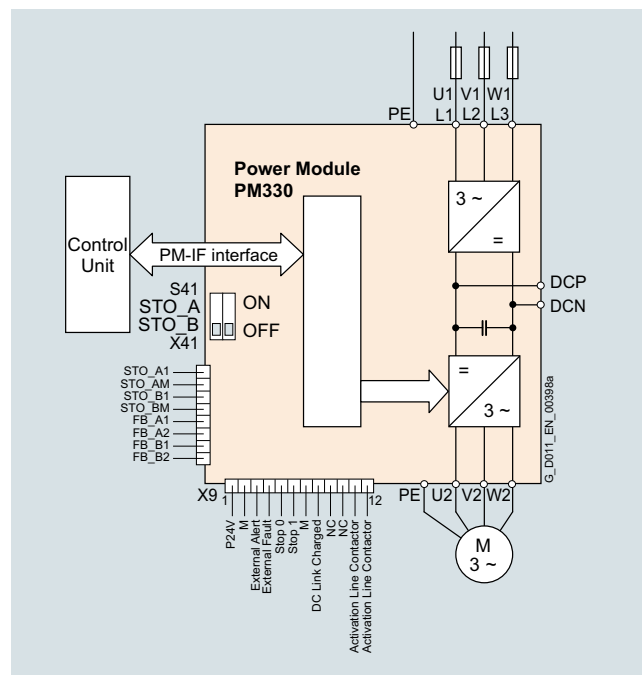

Connection diagram for PM330 Power Module

²⁾ To comply with Category C2, shielded cables must also be used between the converter and motor with a maximum permissible cable length of 150 m (492 ft). Long cables can be used if output reactors and output filters are connected (see section [Load-side power components](#)).

³⁾ The Safety functions are available from functional status FS 04 of the Power Modules.

SINAMICS G120P built-in and wall-mounted units

PM330 Power Modules, 160 kW to 630 kW

PM330 Power Modules

Integration (continued)

Power components that are available depending on the Power Module used

The following line-side power components, DC link components and load-side power components can be ordered additionally in the appropriate frames size for the Power Modules:

PM330 Power Module	Frame sizes GX to JX
Line-side power components	
Line filter	✓
Line reactor	✓
DC link components	
Braking Module with braking resistor	✓ ¹⁾
Load-side power components	
Output reactor	✓
dv/dt filter plus VPL	✓
dv/dt filter compact plus VPL	✓

Selection and ordering data

To ensure that a suitable Power Module is selected, the following currents should be used for applications:

- the base-load current I_L for applications with low overload (LO)
- the base-load current I_H for applications with high overload (HO)

The modules support at least 2-pole and 4-pole low-voltage motors depending on the rated output current. The rated power is merely a guide value. For a description of the overload performance, please refer to the section containing the Power Module characteristics.

Rated power ²⁾		Rated output current I_{rated} A	Base-load current I_L ³⁾ A	Power based on the base-load current I_H ⁴⁾		Base-load current I_H ⁴⁾ A	Frame size	PM330 Power Module Degree of protection IP20 Article No.
400 V/690 V kW	460 V/575 V hp			400 V/690 V kW	460 V/575 V hp			
380 ... 480 V 3 AC								
160	200	300	290	132	150	240	GX	6SL3310-1PE33-0AA0
200	250	370	360	160	200	296	GX	6SL3310-1PE33-7AA0
250	300	460	450	200	200	368	GX	6SL3310-1PE34-6AA0
315	400	585	570	250	300	468	HX	6SL3310-1PE35-8AA0
355	450	655	640	250	300	491	HX	6SL3310-1PE36-6AA0
400	500	735	720	315	350	551	HX	6SL3310-1PE37-4AA0
450	500	840	820	355	450	672	JX	6SL3310-1PE38-4AA0
500	600	910	890	400	500	728	JX	6SL3310-1PE38-8AA0
560	700	1021	1000	450	500	786	JX	6SL3310-1PE41-0AA0
500 ... 690 V 3 AC								
315	350	340	330	250	250	272	HX	6SL3310-1PG33-7AA0
355	400	393	385	315	300	314	HX	6SL3310-1PG34-0AA0
400	450	430	420	355	350	348	HX	6SL3310-1PG34-5AA0
450	450	480	470	400	450	394	HX	6SL3310-1PG35-2AA0
500	500	535	520	450	450	444	JX	6SL3310-1PG35-8AA0
560	600	595	580	500	500	476	JX	6SL3310-1PG36-5AA0
630	700	665	650	560	500	532	JX	6SL3310-1PG37-2AA0

Recommended SIRIUS 3SK1 Safety Relays

Designation	Article No.
SIRIUS Safety Relay for STO	3SK1111-2AB30
SIRIUS Safety Relay for SS1	3SK1121-2CB42

¹⁾ Available for Power Modules with line voltage from 380 V to 480 V.

²⁾ Rated power based on the base-load current I_L .

³⁾ The base-load current I_L is based on the duty cycle for low overload (LO).

⁴⁾ The base-load current I_H is based on the duty cycle for high overload (HO).

SINAMICS G120P built-in and wall-mounted units

PM330 Power Modules, 160 kW to 630 kW

PM330 Power Modules

Technical specifications

General technical specifications

PM330 Power Modules	
Input data	
Line voltages and power ranges	380 ... 480 V 3 AC $\pm 10\%$, 160 ... 560 kW 500 ... 690 V 3 AC $\pm 10\%$, 315 ... 630 kW
Starting current	< rated input current (refer to power-dependent data)
Input frequency	47 ... 63 Hz
Grid requirement	>33 line reactor required
Short-circuit power R_{SC}	
Output data	
Output voltage	0 V 3 AC ... \leq (line voltage \times 0.97)
Output current	(refer to power-dependent data)
Output frequency	0 ... 150 Hz
Pulse frequency	Self-adjusting up to 4 kHz
Power factor λ	0.75 ... 0.93
Offset factor $\cos \varphi$	0.96
Further technical specifications	
Overvoltage category to IEC 61800-5-1	<ul style="list-style-type: none"> • Overvoltage category III: Supply circuits • Overvoltage category II: Non-supply circuits
Braking methods	<ul style="list-style-type: none"> • DC braking • Dynamic braking with external Braking Module with braking resistor
Type of cooling	Forced air cooling AF to EN 60146
Protection functions	<ul style="list-style-type: none"> • Undervoltage • Overvoltage • Overcurrent/overload • Overtemperature • Ground fault • Short-circuit • Stall protection • Motor blocking protection • Motor overtemperature • Converter overtemperature/fan failure • Parameter locking • Detection of single-phase motor cable break • Line phase failure
Standards	
Compliance with standards	cULus, CE, RCM, EAC, KC, SEMI F47 ¹⁾
CE marking	According to EMC Directive 2014/30/EU, Low Voltage Directive 2014/35/EU
RI suppression	According to EMC product standard for variable-speed drives EN 61800-3, "second environment". Can be operated in the "first environment" if line filters are installed.

¹⁾ SEMI F47 for frame sizes HX (500 V to 690 V) and JX available soon.

SINAMICS G120P built-in and wall-mounted units

PM330 Power Modules, 160 kW to 630 kW

PM330 Power Modules

Technical specifications

PM330 Power Modules

Line voltage 380 ... 480 V 3 AC		PM330 Power Modules					
		6SL3310-1PE33-0AA0	6SL3310-1PE33-7AA0	6SL3310-1PE34-6AA0	6SL3310-1PE35-8AA0	6SL3310-1PE36-6AA0	6SL3310-1PE37-4AA0
Rated power ¹⁾							
• Based on the base-load current I_L							
- At 400 V/50 Hz	kW	160	200	250	315	355	400
- At 460 V/60 Hz	hp	200	250	300	400	450	500
• Based on the base-load current I_H							
- At 400 V/50 Hz	kW	132	160	200	250	250	315
- At 460 V/60 Hz	hp	150	200	200	300	300	350
Output current at 50 Hz 3 AC							
• Rated current I_{rated} (400 V ± 10 %)	A	300	370	460	585	655	735
• Rated current I_{rated} (480 V ± 10 %)	A	245	308	369	487	526	602
• Base-load current I_L (400 V ± 10 %) ²⁾	A	290	360	450	570	640	720
• Base-load current I_L (480 V ± 10 %) ²⁾	A	240	302	361	477	515	590
• Base-load current I_H (400 V ± 10 %) ³⁾	A	240	296	368	468	491	551
• Base-load current I_H (480 V ± 10 %) ³⁾	A	196	247	295	390	394	452
• Max. output current I_{max}	A	392	486	608	770	864	972
Rated pulse frequency	kHz	2	2	2	2	2	2
Input current ⁴⁾							
• Rated current I_{rated} (400 V ± 10 %)	A	317	375	469	597	668	750
• Rated current I_{rated} (480 V ± 10 %)	A	262	314	376	497	536	614
• Base-load current I_L (400 V ± 10 %) ²⁾	A	307	365	459	585	654	735
• Base-load current I_L (480 V ± 10 %) ²⁾	A	257	308	368	486	525	602
• Base-load current I_H (400 V ± 10 %) ³⁾	A	254	300	375	477	501	562
• Base-load current I_H (480 V ± 10 %) ³⁾	A	210	251	301	397	402	461
• Max. input current	A	415	493	620	785	881	992
Short-circuit current rating ICC according to IEC in conjunction with the specified fuses	kA	100	100	100	100	100	100
Rated short-circuit current SCCR (Short-Circuit Current Rating) in accordance with UL508C (up to 600 V) in conjunction with the specified fuses	kA	100	100	100	100	100	100
Minimum short-circuit current ⁵⁾							
• For 3NE1 fuses	A	3500	4500	7000	10000	11000	13000
• For 3NA3 fuses	A	9500	14000	20000	20000	30000	30000
Efficiency η At rated current I_{rated} (400 V/45 °C (113 °F))	%	98	98	98.1	98.1	98	98.1
Power loss At rated current I_{rated} (400 V/45 °C (113 °F))	kW	3.642	4.414	5.125	6.791	7.687	8.385
Coolant requirements	m ³ /s (ft ³ /s)	0.21 (7.42)	0.21 (7.42)	0.21 (7.42)	0.36 (12.7)	0.36 (12.7)	0.36 (12.7)
Coolant		Air	Air	Air	Air	Air	Air
Sound pressure level L_{pA} (1 m)	dB	74	74	74	74	74	74
Power requirement 24 V DC supply	A	0.5	0.5	0.5	0.5	0.5	0.5

¹⁾ Rated power of a typical 4-pole standard induction motor based on the base-load current I_L or I_H at 400 V 3 AC/50 Hz (kW) or 460 V 3 AC/60 Hz (hp).

²⁾ The base-load current I_L is based on the duty cycle for low overload (LO).

³⁾ The base-load current I_H is based on the duty cycle for high overload (HO).

⁴⁾ The input current depends on the motor load and line impedance and applies for a line impedance corresponding to $u_K = 1$ %. The rated input currents apply for a load at rated power (based on I_{rated}) – these current values are specified on the rating plate.

⁵⁾ 10 ms value from current-time characteristic for reliable tripping of installed protection devices. If the minimum short-circuit current is not reached, the tripping time of the fuses is increased, which can lead to damage.

SINAMICS G120P built-in and wall-mounted units

PM330 Power Modules, 160 kW to 630 kW

PM330 Power Modules

Technical specifications (continued)

Line voltage 380 ... 480 V 3 AC		PM330 Power Modules					
		6SL3310-1PE33-0AA0	6SL3310-1PE33-7AA0	6SL3310-1PE34-6AA0	6SL3310-1PE35-8AA0	6SL3310-1PE36-6AA0	6SL3310-1PE37-4AA0
Line supply connection U1/L1, V1/L2, W1/L3		M12 screw	M12 screw	M12 screw	M12 screw	M12 screw	M12 screw
• Conductor cross section, max. (IEC)	mm ²	2 × 240	2 × 240	2 × 240	4 × 240	4 × 240	4 × 240
Motor connection U2, V2, W2		M12 screw	M12 screw	M12 screw	M12 screw	M12 screw	M12 screw
• Conductor cross section, max. (IEC)	mm ²	2 × 240	2 × 240	2 × 240	4 × 240	4 × 240	4 × 240
DC link connection DCP, DCN		M12 screw	M12 screw	M12 screw	M12 screw	M12 screw	M12 screw
• Conductor cross section, max. (IEC)	mm ²	2 × 240	2 × 240	2 × 240	4 × 240	4 × 240	4 × 240
PE/GND connection		M12 screw	M12 screw	M12 screw	M12 screw	M12 screw	M12 screw
• Conductor cross section, max. (IEC)	mm ²	3 × 240	3 × 240	3 × 240	(4+6) × 240	(4+6) × 240	(4+6) × 240
Cable length, max. between Power Module and motor							
• When compliant with Categories C2 and C3 according to EN 61800-3 shielded	m (ft)	150 (492)	150 (492)	150 (492)	150 (492)	150 (492)	150 (492)
• When non-compliant with the limit values for RI suppression and without output reactor or dv/dt filter unshielded	m (ft)	200 (656)	200 (656)	200 (656)	200 (656)	200 (656)	200 (656)
• When non-compliant with the limit values for RI suppression with output reactor or dv/dt filter shielded/unshielded	m (ft)	300/450 (984/1476)	300/450 (984/1476)	300/450 (984/1476)	300/450 (984/1476)	300/450 (984/1476)	300/450 (984/1476)
Degree of protection		IP20	IP20	IP20	IP20	IP20	IP20
Dimensions							
• Width	mm (in)	452 (17.8)	452 (17.8)	452 (17.8)	548 (21.6)	548 (21.6)	548 (21.6)
• Height	mm (in)	1447 (57.0)	1447 (57.0)	1447 (57.0)	1696 (66.8)	1696 (66.8)	1696 (66.8)
• Depth	mm (in)	327.5 (12.9)	327.5 (12.9)	327.5 (12.9)	393 (15.5)	393 (15.5)	393 (15.5)
Frame size		GX	GX	GX	HX	HX	HX
Weight, approx.	kg (lb)	98 (216)	104 (229)	109 (240)	151 (333)	157 (346)	159 (351)
Minimum size of control cabinet for installation of a Power Module							
• Width	mm (in)	No specifications	No specifications	No specifications	800 (31.5)	800 (31.5)	800 (31.5)
• Height	mm (in)	No specifications	No specifications	No specifications	2000 (78.7)	2000 (78.7)	2000 (78.7)
• Depth	mm (in)	No specifications	No specifications	No specifications	600 (23.6)	600 (23.6)	600 (23.6)

SINAMICS G120P built-in and wall-mounted units

PM330 Power Modules, 160 kW to 630 kW

PM330 Power Modules

Technical specifications (continued)

Line voltage 380 ... 480 V 3 AC		PM330 Power Modules		
		6SL3310-1PE38-4AA0	6SL3310-1PE38-8AA0	6SL3310-1PE41-0AA0
Rated power ¹⁾				
• Based on the base-load current I_L				
- At 400 V/50 Hz	kW	450	500	560
- At 460 V/60 Hz	hp	500	600	700
• Based on the base-load current I_H				
- At 400 V/50 Hz	kW	355	400	450
- At 460 V/60 Hz	hp	450	500	500
Output current at 50 Hz 3 AC				
• Rated current I_{rated} (400 V ± 10 %)	A	840	910	1021
• Rated current I_{rated} (480 V ± 10 %)	A	677	739	847
• Base-load current I_L (400 V ± 10 %) ²⁾	A	820	890	1000
• Base-load current I_L (480 V ± 10 %) ²⁾	A	663	724	830
• Base-load current I_H (400 V ± 10 %) ³⁾	A	672	728	786
• Base-load current I_H (480 V ± 10 %) ³⁾	A	542	591	652
• Max. output current I_{max}	A	1107	1202	1350
Rated pulse frequency	kHz	2	2	2
Input current ⁴⁾				
• Rated current I_{rated} (400 V ± 10 %)	A	870	945	1061
• Rated current I_{rated} (480 V ± 10 %)	A	702	767	880
• Base-load current I_L (400 V ± 10 %) ²⁾	A	850	924	1038
• Base-load current I_L (480 V ± 10 %) ²⁾	A	687	751	862
• Base-load current I_H (400 V ± 10 %) ³⁾	A	696	756	816
• Base-load current I_H (480 V ± 10 %) ³⁾	A	561	614	677
• Max. input current	A	1147	1248	1402
Short-circuit current rating ICC according to IEC in conjunction with the specified fuses	kA	100	100	100
Rated short-circuit current SCCR (Short-Circuit Current Rating) in accordance with UL 61800-5-1 (up to 600 V) in conjunction with the specified fuses	kA	100	100	100
Minimum short-circuit current ⁵⁾				
• For 3NE1 fuses	A	10400	14000	16000
• For 3NA3 fuses	A	40000	40000	52000
• For 3NB3 fuses	A	8600	17000	18000
Efficiency η At rated current I_{rated} (400 V/45 °C (113 °F))	%	98	98	98
Power loss At rated current I_{rated} (400 V/45 °C (113 °F))	kW	10.418	10.885	12.495
Coolant requirements	m ³ /s (ft ³ /s)	0.45 (15.9)	0.45 (15.9)	0.45 (15.9)
Coolant		Air	Air	Air
Sound pressure level L_{pA} (1 m)	dB	74	74	74
Power requirement 24 V DC supply	A	0.5	0.5	0.5

¹⁾ Rated power of a typical 4-pole standard induction motor based on the base-load current I_L or I_H at 400 V 3 AC/50 Hz (kW) or 460 V 3 AC/60 Hz (hp).

²⁾ The base-load current I_L is based on the duty cycle for low overload (LO).

³⁾ The base-load current I_H is based on the duty cycle for high overload (HO).

⁴⁾ The input current depends on the motor load and line impedance and applies for a line impedance corresponding to $u_K = 1$ %. The rated input currents apply for a load at rated power (based on I_{rated}) – these current values are specified on the rating plate.

⁵⁾ 10 ms value from current-time characteristic for reliable tripping of installed protection devices. If the minimum short-circuit current is not reached, the tripping time of the fuses is increased, which can lead to damage.

SINAMICS G120P built-in and wall-mounted units

PM330 Power Modules, 160 kW to 630 kW

PM330 Power Modules

Technical specifications (continued)

Line voltage 380 ... 480 V 3 AC		PM330 Power Modules		
		6SL3310-1PE38-4AA0	6SL3310-1PE38-8AA0	6SL3310-1PE41-0AA0
Line supply connection U1/L1, V1/L2, W1/L3		M12 screw	M12 screw	M12 screw
• Conductor cross section, max. (IEC)	mm ²	6 × 240	6 × 240	6 × 240
Motor connection U2, V2, W2		M12 screw	M12 screw	M12 screw
• Conductor cross section, max. (IEC)	mm ²	4 × 240	8 × 240	8 × 240
DC link connection DCP, DCN		M12 screw	M12 screw	M12 screw
• Conductor cross section, max. (IEC)	mm ²	4 × 240	4 × 240	4 × 240
PE/GND connection		M12 screw	M12 screw	M12 screw
• Conductor cross section, max. (IEC)	mm ²	6 × 240	6 × 240	6 × 240
Cable length, max. between Power Module and motor				
• When compliant with Categories C2 and C3 according to EN 61800-3 shielded	m (ft)	150 (492)	150 (492)	150 (492)
• When non-compliant with the limit values for RI suppression and without output reactor or dv/dt filter unshielded	m (ft)	200 (656)	200 (656)	200 (656)
• When non-compliant with the limit values for RI suppression with output reactor or dv/dt filter shielded/unshielded	m (ft)	300/450 (984/1476)	300/450 (984/1476)	300/450 (984/1476)
Degree of protection		IP20	IP20	IP20
Dimensions				
• Width	mm (in)	801 (31.5)	801 (31.5)	801 (31.5)
• Height	mm (in)	1621 (63.8)	1621 (63.8)	1621 (63.8)
• Depth	mm (in)	393 (15.5)	393 (15.5)	393 (15.5)
Frame size		JX	JX	JX
Weight, approx.		kg (lb)	235 (518)	250 (551)
Minimum size of control cabinet for installation of a Power Module				
• Width	mm (in)	No specifications	No specifications	No specifications
• Height	mm (in)	No specifications	No specifications	No specifications
• Depth	mm (in)	No specifications	No specifications	No specifications

SINAMICS G120P built-in and wall-mounted units

PM330 Power Modules, 160 kW to 630 kW

PM330 Power Modules

Technical specifications (continued)

Line voltage 500 ... 690 V 3 AC		PM330 Power Modules			
		6SL3310-1PG33-7AA0	6SL3310-1PG34-0AA0	6SL3310-1PG34-5AA0	6SL3310-1PG35-2AA0
Rated power ¹⁾					
• Based on the base-load current I_L					
- At 690 V/50 Hz	kW	315	355	400	450
- At 575 V/60 Hz	hp	350	400	450	450
• Based on the base-load current I_H					
- At 690 V/50 Hz	kW	250	315	355	400
- At 575 V/60 Hz	hp	250	300	350	450
Output current at 50 Hz 3 AC					
• Rated current I_{rated} (500 V $\pm 10\%$)	A	368	400	453	516
• Rated current I_{rated} (600 V $\pm 10\%$)	A	353	396	441	497
• Rated current I_{rated} (690 V $\pm 10\%$)	A	340	393	430	480
• Base-load current I_L (500 V $\pm 10\%$) ²⁾	A	361	392	443	505
• Base-load current I_L (690 V $\pm 10\%$) ²⁾	A	330	385	420	470
• Base-load current I_H (500 V $\pm 10\%$) ³⁾	A	295	320	367	423
• Base-load current I_H (690 V $\pm 10\%$) ³⁾	A	272	314	348	394
• Max. output current I_{max}	A	487	529	598	682
Rated pulse frequency	kHz	2	2	2	2
Input current ⁴⁾					
• Rated current I_{rated} (500 V $\pm 10\%$)	A	383	416	471	537
• Rated current I_{rated} (600 V $\pm 10\%$)	A	367	412	459	517
• Rated current I_{rated} (690 V $\pm 10\%$)	A	354	409	447	499
• Base-load current I_L (500 V $\pm 10\%$) ²⁾	A	375	408	461	526
• Base-load current I_L (690 V $\pm 10\%$) ²⁾	A	343	401	437	489
• Base-load current I_H (500 V $\pm 10\%$) ³⁾	A	307	333	381	440
• Base-load current I_H (690 V $\pm 10\%$) ³⁾	A	283	327	362	410
• Max. input current	A	507	550	623	710
Short-circuit current rating ICC according to IEC in conjunction with the specified fuses	kA	100	100	100	100
Rated short-circuit current SCCR (Short-Circuit Current Rating) in accordance with UL 61800-5-1 (up to 600 V) in conjunction with the specified fuses	kA	100	100	100	100
Minimum short-circuit current ⁵⁾					
• For 3NE1 fuses	A	3500	4500	7000	8500
Efficiency η at rated current I_{rated} (690 V/45 °C (113 °F))	%	98.2	98.2	98.2	98.2
Power loss at rated current I_{rated} (690 V/45 °C (113 °F))	kW	5.402	6.191	6.884	7.716
Coolant requirements	m ³ /s (ft ³ /s)	0.362 (12.8)	0.362 (12.8)	0.362 (12.8)	0.362 (12.8)
Coolant		Air	Air	Air	Air
Sound pressure level L_{pA} (1 m)	dB	74	74	74	74
Power requirement 24 V DC supply	A	0.5	0.5	0.5	0.5

¹⁾ Rated power of a typical 4-pole standard induction motor based on the base-load current I_L or I_H at 690 V 3 AC/50 Hz (kW) or 575 V 3 AC/60 Hz (hp).

²⁾ The base-load current I_L is based on the duty cycle for low overload (LO).

³⁾ The base-load current I_H is based on the duty cycle for high overload (HO).

⁴⁾ The input current depends on the motor load and line impedance and applies for a line impedance corresponding to $u_K = 1\%$. The rated input currents apply for a load at rated power (based on I_{rated}) – these current values are specified on the rating plate.

⁵⁾ 10 ms value from current-time characteristic for reliable tripping of installed protection devices. If the minimum short-circuit current is not reached, the tripping time of the fuses is increased, which can lead to damage.

SINAMICS G120P built-in and wall-mounted units

PM330 Power Modules, 160 kW to 630 kW

PM330 Power Modules**Technical specifications (continued)**

Line voltage 500 ... 690 V 3 AC		PM330 Power Modules			
		6SL3310-1PG33-7AA0	6SL3310-1PG34-0AA0	6SL3310-1PG34-5AA0	6SL3310-1PG35-2AA0
Line supply connection U1/L1, V1/L2, W1/L3		M12 screw	M12 screw	M12 screw	M12 screw
• Conductor cross section, max. (IEC)	mm ²	4 × 240	4 × 240	4 × 240	4 × 240
Motor connection U2, V2, W2		M12 screw	M12 screw	M12 screw	M12 screw
• Conductor cross section, max. (IEC)	mm ²	4 × 240	4 × 240	4 × 240	4 × 240
DC link connection DCP, DCN		M12 screw	M12 screw	M12 screw	M12 screw
• Conductor cross section, max. (IEC)	mm ²	4 × 240	4 × 240	4 × 240	4 × 240
PE/GND connection		M12 screw	M12 screw	M12 screw	M12 screw
• Conductor cross section, max. (IEC)	mm ²	(4+6) × 240	(4+6) × 240	(4+6) × 240	(4+6) × 240
Cable length, max. between Power Module and motor					
• When compliant with Categories C2 and C3 according to EN 61800-3 shielded	m (ft)	150 (492)	150 (492)	150 (492)	150 (492)
• When non-compliant with the limit values for RI suppression and without output reactor or dv/dt filter unshielded	m (ft)	200 (656)	200 (656)	200 (656)	200 (656)
• When non-compliant with the limit values for RI suppression with output reactor or dv/dt filter shielded/unshielded	m (ft)	300/450 (984/1476)	300/450 (984/1476)	300/450 (984/1476)	300/450 (984/1476)
Degree of protection		IP20	IP20	IP20	IP20
Dimensions					
• Width	mm (in)	548 (21.6)	548 (21.6)	548 (21.6)	548 (21.6)
• Height	mm (in)	1695 (66.7)	1695 (66.7)	1695 (66.7)	1695 (66.7)
• Depth	mm (in)	393 (15.5)	393 (15.5)	393 (15.5)	393 (15.5)
Frame size		HX	HX	HX	HX
Weight, approx.		kg (lb)	kg (lb)	kg (lb)	kg (lb)
		158 (348)	158 (348)	162 (357)	162 (357)
Minimum size of control cabinet for installation of a Power Module					
• Width	mm (in)	800 (31.5)	800 (31.5)	800 (31.5)	800 (31.5)
• Height	mm (in)	2000 (78.7)	2000 (78.7)	2000 (78.7)	2000 (78.7)
• Depth	mm (in)	600 (23.6)	600 (23.6)	600 (23.6)	600 (23.6)

SINAMICS G120P built-in and wall-mounted units

PM330 Power Modules, 160 kW to 630 kW

PM330 Power Modules

Technical specifications (continued)

Line voltage 500 ... 690 V 3 AC		PM330 Power Modules		
		6SL3310-1PG35-8AA0	6SL3310-1PG36-5AA0	6SL3310-1PG37-2AA0
Rated power ¹⁾				
• Based on the base-load current I_L				
- At 690 V/50 Hz	kW	500	560	630
- At 575 V/60 Hz	hp	500	600	700
• Based on the base-load current I_H				
- At 690 V/50 Hz	kW	450	500	560
- At 575 V/60 Hz	hp	450	500	500
Output current at 50 Hz 3 AC				
• Rated current I_{rated} (500 V ± 10 %)	A	581	654	725
• Rated current I_{rated} (600 V ± 10 %)	A	557	623	693
• Rated current I_{rated} (690 V ± 10 %)	A	535	595	665
• Base-load current I_L (500 V ± 10 %) ²⁾	A	569	640	710
• Base-load current I_L (690 V ± 10 %) ²⁾	A	520	580	650
• Base-load current I_H (500 V ± 10 %) ³⁾	A	482	523	580
• Base-load current I_H (690 V ± 10 %) ³⁾	A	444	476	532
• Max. output current I_{max}	A	768	864	959
Rated pulse frequency	kHz	2	2	2
Input current ⁴⁾				
• Rated current I_{rated} (500 V ± 10 %)	A	596	679	753
• Rated current I_{rated} (600 V ± 10 %)	A	578	647	720
• Rated current I_{rated} (690 V ± 10 %)	A	555	618	690
• Base-load current I_L (500 V ± 10 %) ²⁾	A	591	665	737
• Base-load current I_L (690 V ± 10 %) ²⁾	A	540	602	675
• Base-load current I_H (500 V ± 10 %) ³⁾	A	501	543	602
• Base-load current I_H (690 V ± 10 %) ³⁾	A	461	494	552
• Max. input current	A	798	897	995
Short-circuit current rating ICC according to IEC in conjunction with the specified fuses	kA	100	100	100
Rated short-circuit current SCCR (Short-Circuit Current Rating) in accordance with UL 61800-5-1 (up to 600 V) in conjunction with the specified fuses	kA	100	100	100
Minimum short-circuit current ⁵⁾				
• For 3NE1 fuses	A	10000	11000	13000
Efficiency η at rated current I_{rated} (690 V/45 °C (113 °F))	%	98.3	98.3	98.3
Power loss at rated current I_{rated} (690 V/45 °C (113 °F))	kW	8.134	8.828	9.937
Coolant requirements	m ³ /s (ft ³ /s)	0.45 (15.9)	0.45 (15.9)	0.45 (15.9)
Coolant		Air	Air	Air
Sound pressure level L_{pA} (1 m)	dB	74	74	74
Power requirement 24 V DC supply	A	0.5	0.5	0.5

¹⁾ Rated power of a typical 4-pole standard induction motor based on the base-load current I_L or I_H at 690 V 3 AC/50 Hz (kW) or 575 V 3 AC/60 Hz (hp).

²⁾ The base-load current I_L is based on the duty cycle for low overload (LO).

³⁾ The base-load current I_H is based on the duty cycle for high overload (HO).

⁴⁾ The input current depends on the motor load and line impedance and applies for a line impedance corresponding to $u_K = 1$ %. The rated input currents apply for a load at rated power (based on I_{rated}) – these current values are specified on the rating plate.

⁵⁾ 10 ms value from current-time characteristic for reliable tripping of installed protection devices. If the minimum short-circuit current is not reached, the tripping time of the fuses is increased, which can lead to damage.

SINAMICS G120P built-in and wall-mounted units

PM330 Power Modules, 160 kW to 630 kW

PM330 Power Modules

Technical specifications (continued)

Line voltage 500 ... 690 V 3 AC		PM330 Power Modules		
		6SL3310-1PG35-8AA0	6SL3310-1PG36-5AA0	6SL3310-1PG37-2AA0
Line supply connection U1/L1, V1/L2, W1/L3		M12 screw	M12 screw	M12 screw
• Conductor cross section, max. (IEC)	mm ²	6 × 240	6 × 240	6 × 240
Motor connection U2, V2, W2		M12 screw	M12 screw	M12 screw
• Conductor cross section, max. (IEC)	mm ²	4 × 240	4 × 240	4 × 240
DC link connection DCP, DCN		M12 screw	M12 screw	M12 screw
• Conductor cross section, max. (IEC)	mm ²	4 × 240	4 × 240	4 × 240
PE/GND connection		M12 screw	M12 screw	M12 screw
• Conductor cross section, max. (IEC)	mm ²	6 × 240	6 × 240	6 × 240
Cable length, max. between Power Module and motor				
• When compliant with Categories C2 and C3 according to EN 61800-3 shielded	m (ft)	150 (492)	150 (492)	150 (492)
• When non-compliant with the limit values for RI suppression and without output reactor or dv/dt filter unshielded	m (ft)	200 (656)	200 (656)	200 (656)
• When non-compliant with the limit values for RI suppression with output reactor or dv/dt filter shielded/unshielded	m (ft)	300/450 (984/1476)	300/450 (984/1476)	300/450 (984/1476)
Degree of protection		IP20	IP20	IP20
Dimensions				
• Width	mm (in)	801 (31.5)	801 (31.5)	801 (31.5)
• Height	mm (in)	1621 (63.8)	1621 (63.8)	1621 (63.8)
• Depth	mm (in)	393 (15.5)	393 (15.5)	393 (15.5)
Frame size		JX	JX	JX
Weight, approx.		kg (lb)	234 (516)	244 (538)
Minimum size of control cabinet for installation of a Power Module				
• Width	mm (in)	No specifications	No specifications	No specifications
• Height	mm (in)	No specifications	No specifications	No specifications
• Depth	mm (in)	No specifications	No specifications	No specifications

SINAMICS G120P built-in and wall-mounted units

PM330 Power Modules, 160 kW to 630 kW

PM330 Power Modules

Characteristic curves

Derating data

The PM330 Power Modules and the associated system components are rated for an ambient temperature of 45 °C (113 °F) and installation altitudes of up to 1000 m (3281 ft) above sea level. At ambient temperatures of > 45 °C (113 °F), the output current must be reduced. Ambient temperatures above 55 °C (131 °F) are not permissible.

At installation altitudes > 1000 m (3281 ft) above sea level, it must be taken into account that the air pressure, and therefore air density, decreases as the height increases. As a consequence, the cooling efficiency and the insulation capacity of the air also decrease. Due to the reduced cooling efficiency, it is necessary, on the one hand, to reduce the ambient temperature, and on the other hand, to lower heat loss in the built-in unit by reducing the output current.

As additional measure for installation altitudes from 2000 m (6562 ft) up to 4000 m (13124 ft), an isolating transformer is required in order to reduce transient overvoltages according to EN 60664-1.

Automatic adjustment of pulse frequency

In the factory setting, the drive starts with a pulse frequency of 4 kHz and reduces the pulse frequency automatically to the associated required frequencies when loaded. When the load decreases, the pulse frequency is increased automatically up to 4 kHz. The values of the rated current apply to a pulse frequency of 2 kHz and an ambient temperature of 45 °C (113 °F) and are reached at any time by the automatic adaptation of the output pulse frequency.

Current derating as a function of the installation altitude and the ambient temperature

At installation altitudes above 1000 m (3281 ft), the permissible output current can be compensated to a certain extent using the ambient temperature.

Current derating as a function of the installation altitude and the ambient temperature for Power Modules PM330 frame size GX

Installation altitude above sea level m (ft)	Current derating factor (in % of the rated output current) at an ambient temperature of							
	20 °C (68 °F)	25 °C (77 °F)	30 °C (86 °F)	35 °C (95 °F)	40 °C (104 °F)	45 °C (113 °F)	50 °C (122 °F)	55 °C (131 °F)
0 ... 1000 (0 ... 3281)							93 %	85 %
1001 ... 1500 (3284 ... 4921)						96 %	89 %	81 %
1501 ... 2000 (4925 ... 6562)			100 %		99 %	92 %	85 %	78 %
2001 ... 2500 (6565 ... 8202)					94 %	88 %	81 %	74 %
2501 ... 3000 (8206 ... 9843)				96 %	90 %	83 %	77 %	71 %
3001 ... 3500 (9846 ... 11483)			97 %	91 %	85 %	79 %	73 %	67 %
3501 ... 4000 (11487 ... 13123)	98 %	92 %	86 %	81 %	75 %	69 %	64 %	

Current derating as a function of the installation altitude and the ambient temperature for Power Modules PM330 frame sizes HX and JX

Installation altitude above sea level m (ft)	Current derating factor (in % of the rated output current) at an ambient temperature of							
	20 °C (68 °F)	25 °C (77 °F)	30 °C (86 °F)	35 °C (95 °F)	40 °C (104 °F)	45 °C (113 °F)	50 °C (122 °F)	55 °C (131 °F)
0 ... 1000 (0 ... 3281)							93 %	85 %
1001 ... 1500 (3284 ... 4921)						97 %	89 %	82 %
1501 ... 2000 (4925 ... 6562)			100 %			93 %	86 %	79 %
2001 ... 2500 (6565 ... 8202)					97 %	90 %	83 %	76 %
2501 ... 3000 (8206 ... 9843)					94 %	87 %	80 %	74 %
3001 ... 3500 (9846 ... 11483)				96 %	90 %	84 %	77 %	71 %
3501 ... 4000 (11487 ... 13123)		98 %	92 %	86 %	80 %	74 %	68 %	

Note:

The connected motors and power elements must be considered separately.

Note:

The operating temperature ranges of the Control Units must be taken into account (see [technical specifications of Control Units](#)).

SINAMICS G120P built-in and wall-mounted units

PM330 Power Modules, 160 kW to 630 kW

PM330 Power Modules

Characteristic curves (continued)

Derating data (continued)

Current derating as a function of the line voltage

PM330 Power Modules supply a constant power over the full permissible range of line voltage.

The constant power results in current derating as a function of the line voltage.

PM330 Power Module	Rated power based on the base-load current I_L at 400 V	Rated output current in A at a line voltage of				
		380 V	400 V	415 V ¹⁾	460 V	480 V
6SL3310-1PE33-0AA0	160	300	300	290	259	245
1PE33-7AA0	200	370	370	358	325	308
1PE34-6AA0	250	460	460	443	393	369
1PE35-8AA0	315	585	585	567	513	487
1PE36-6AA0	355	655	655	631	559	526
1PE37-4AA0	400	735	735	710	636	602
1PE38-4AA0	450	840	840	810	717	677
1PE38-8AA0	500	910	910	877	791	739
1PE41-0AA0	560	1021	1021	988	891	847

PM330 Power Module	Rated power based on the base-load current I_L at 690 V	Rated output current in A at a line voltage of				
		500 V	575 V	600 V	660 V	690 V
6SL3310-1PG33-7AA0	315	368	357	353	344	340
1PG34-0AA0	355	400	397	396	394	393
1PG34-5AA0	400	453	444	441	434	430
1PG35-2AA0	450	516	502	497	486	480
1PG35-8AA0	500	581	563	554	542	535
1PG36-5AA0	560	654	631	623	604	595
1PG37-2AA0	630	725	701	693	674	665

Operating ranges

An additional dimensioning aid is available for all PM330 Power Modules. The purpose of this aid is to ensure the constant reliable operation of the converter, in particular with regard to service life expectancy.

The dimensioning aid clearly distinguishes between continuous operating ranges and short-time operating ranges. As a result, due consideration can be given to operating ranges when the plant is configured. For further details, please refer to the diagram below and the explanatory text.

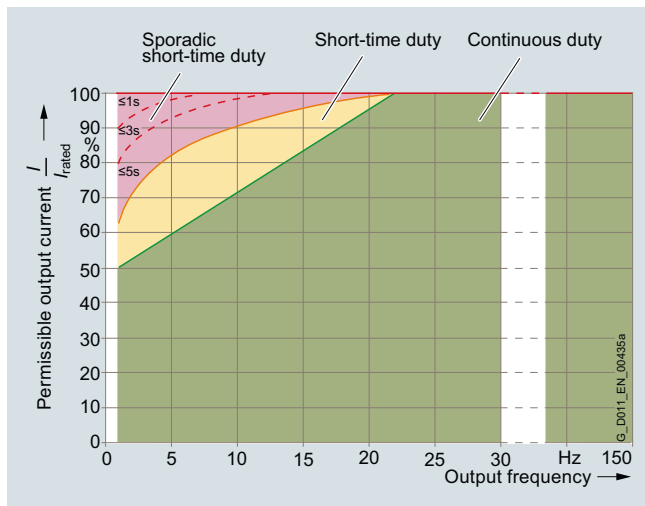

Continuous operation (green area) permissible.

Short-time operation (yellow area) permissible for 2 % of the total operating period without significant reduction in the converter service life; no overload reaction triggered by the thermal monitoring model.

Sporadic short-time operation (red area) permissible for only very short, rare operating states lasting less than 0.1 % of the total operating period without significant reduction in the converter service life; no overload reaction triggered by the thermal monitoring model on condition of compliance with the duty times specified in the diagram.

Overload capability

PM330 Power Modules have an overload reserve e.g. to handle breakaway torques. If larger surge loads occur, this must be taken into account when configuring. In drives with overload requirements, the appropriate base-load current must, therefore, be used as a basis for the required load.

The unit can operate in two different duty cycles in the permissible continuous operating range shown in the diagram (green area). Depending on how the system is dimensioned, the relevant base-load current is effective as a rated quantity.

The criterion for overload is that the converter is operated with its base-load current before and after the overload occurs on the basis of a duty cycle duration of 300 s.

The base-load current for a low overload I_L is the basis for a duty cycle of 110 % for 60 s or 135 % for 3 s.

The base-load current I_H for a high overload is based on a duty cycle of 150 % for 60 s.

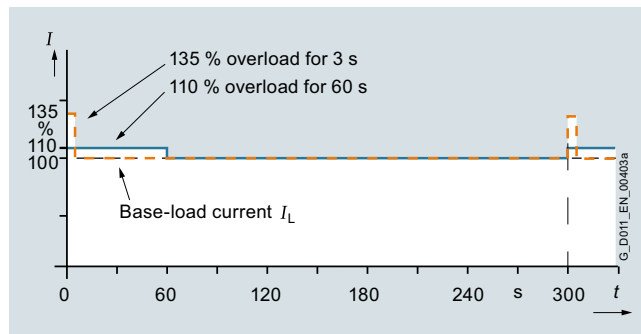

Overload capability, low overload

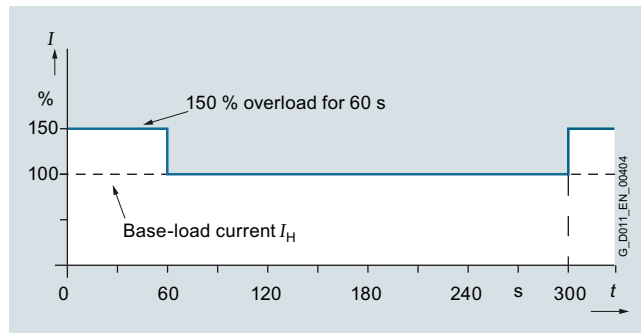

Overload capability, high overload

1) Complete rated current up to 440 V, therefore no derating for 415 V ± 5%.

SINAMICS G120P built-in and wall-mounted units

PM330 Power Modules, 160 kW to 630 kW

PM330 Power Modules

Dimensional drawings

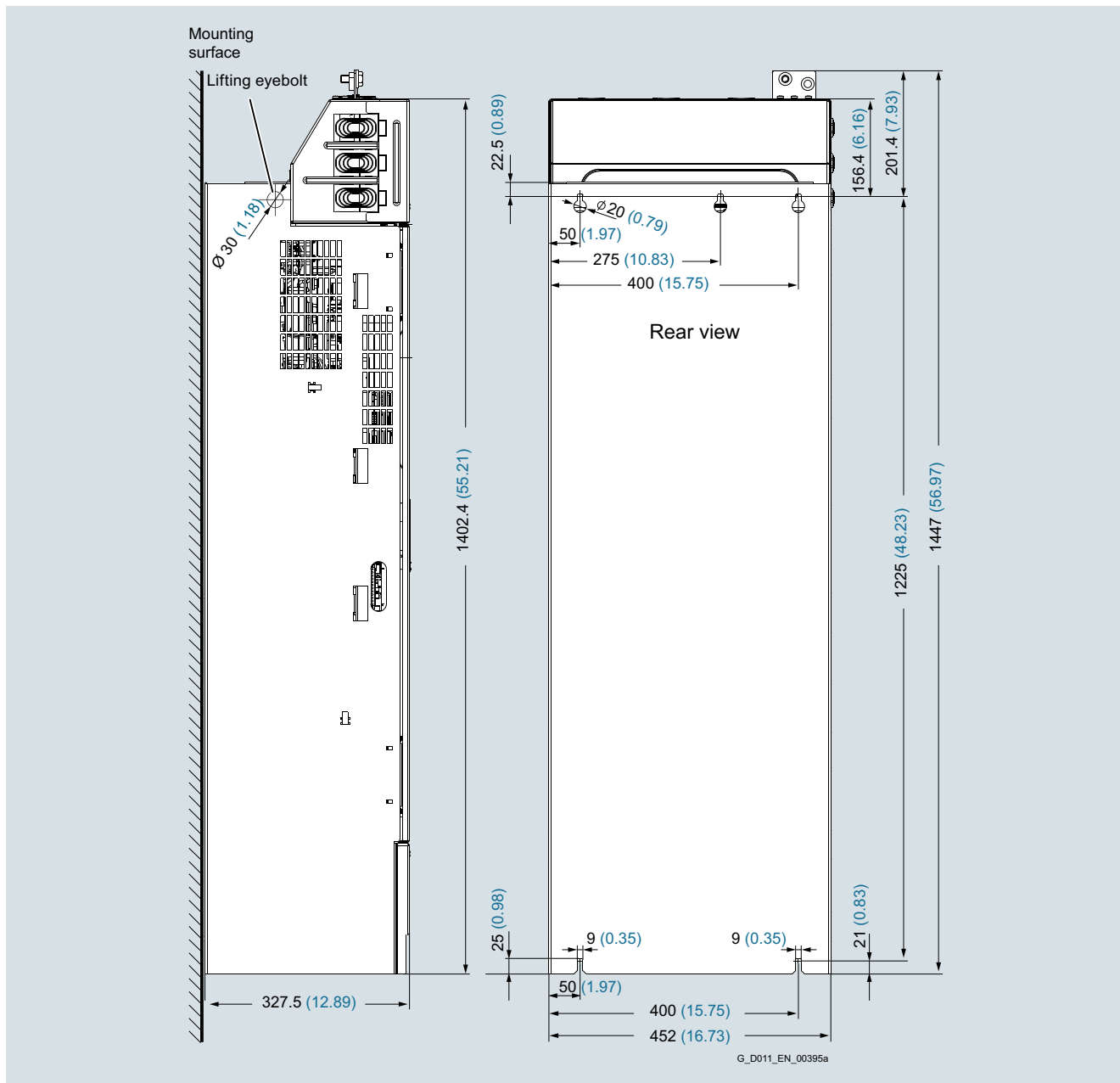

Principle dimension drawing and drill pattern for PM330 Power Modules, frame size GX

Secured with M8 bolts

Ventilation clearance required at top and bottom: 200 mm (7.87 in)

Ventilation clearance required at sides: 30 mm (1.18 in)

Ventilation clearance required at front: 30 mm (1.18 in)

The PM330 Power Modules are designed for installation in a control cabinet.

All dimensions in mm (values in brackets are in inches).

SINAMICS G120P built-in and wall-mounted units

PM330 Power Modules, 160 kW to 630 kW

PM330 Power Modules

Dimensional drawings (continued)

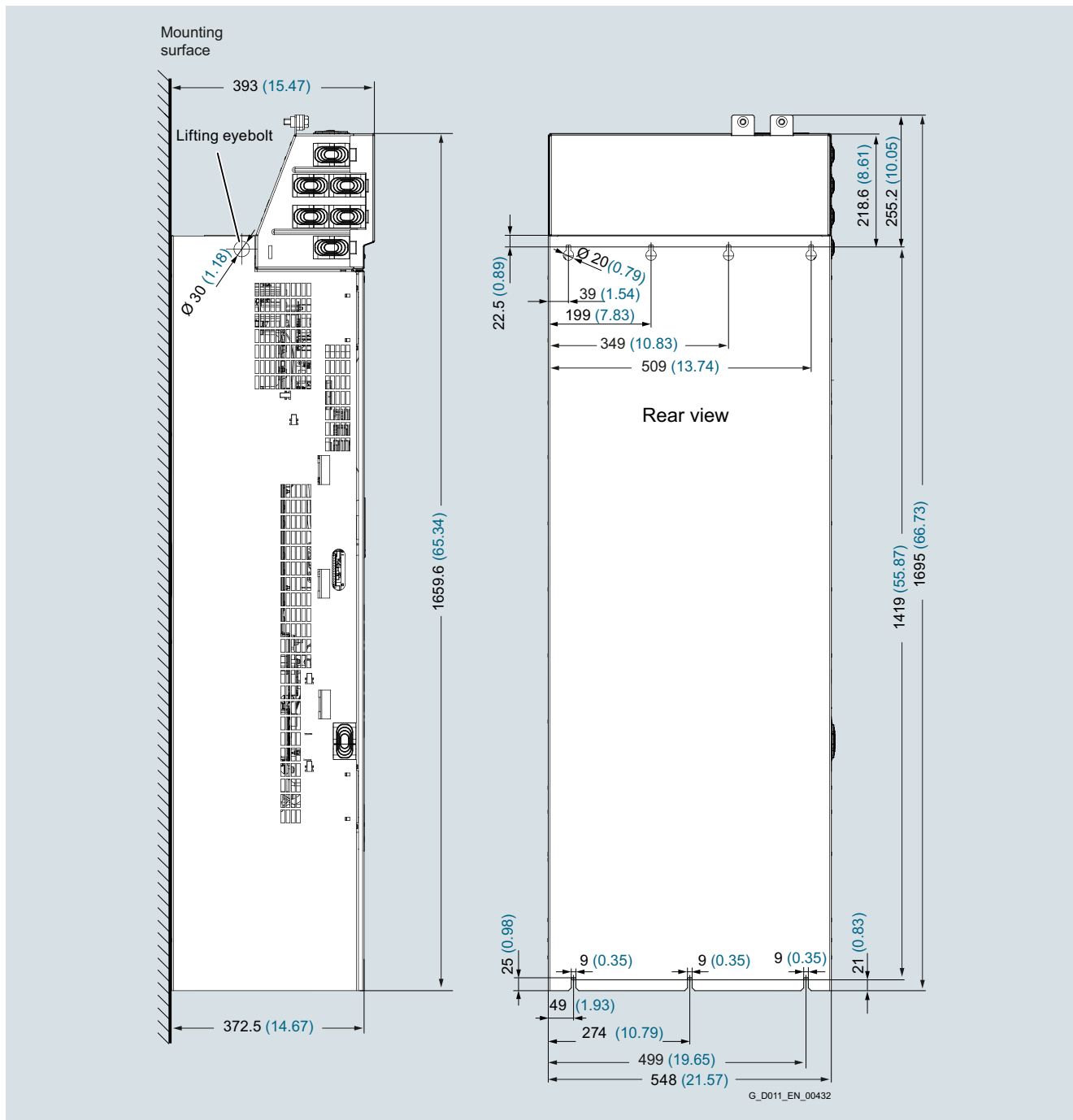

Principle dimension drawing and drill pattern for PM330 Power Modules, frame size HX

Secured with M8 bolts

Ventilation clearance required at the top: 200 mm (7.87 in)

Ventilation clearance required at the bottom: 250 mm (9.84 in)

Ventilation clearance required at sides: 30 mm (1.18 in)

Ventilation clearance required at front: 100 mm (3.94 in)

The PM330 Power Modules are designed for installation in a control cabinet.

All dimensions in mm (values in brackets are in inches).

SINAMICS G120P built-in and wall-mounted units

PM330 Power Modules, 160 kW to 630 kW

PM330 Power Modules

Dimensional drawings (continued)

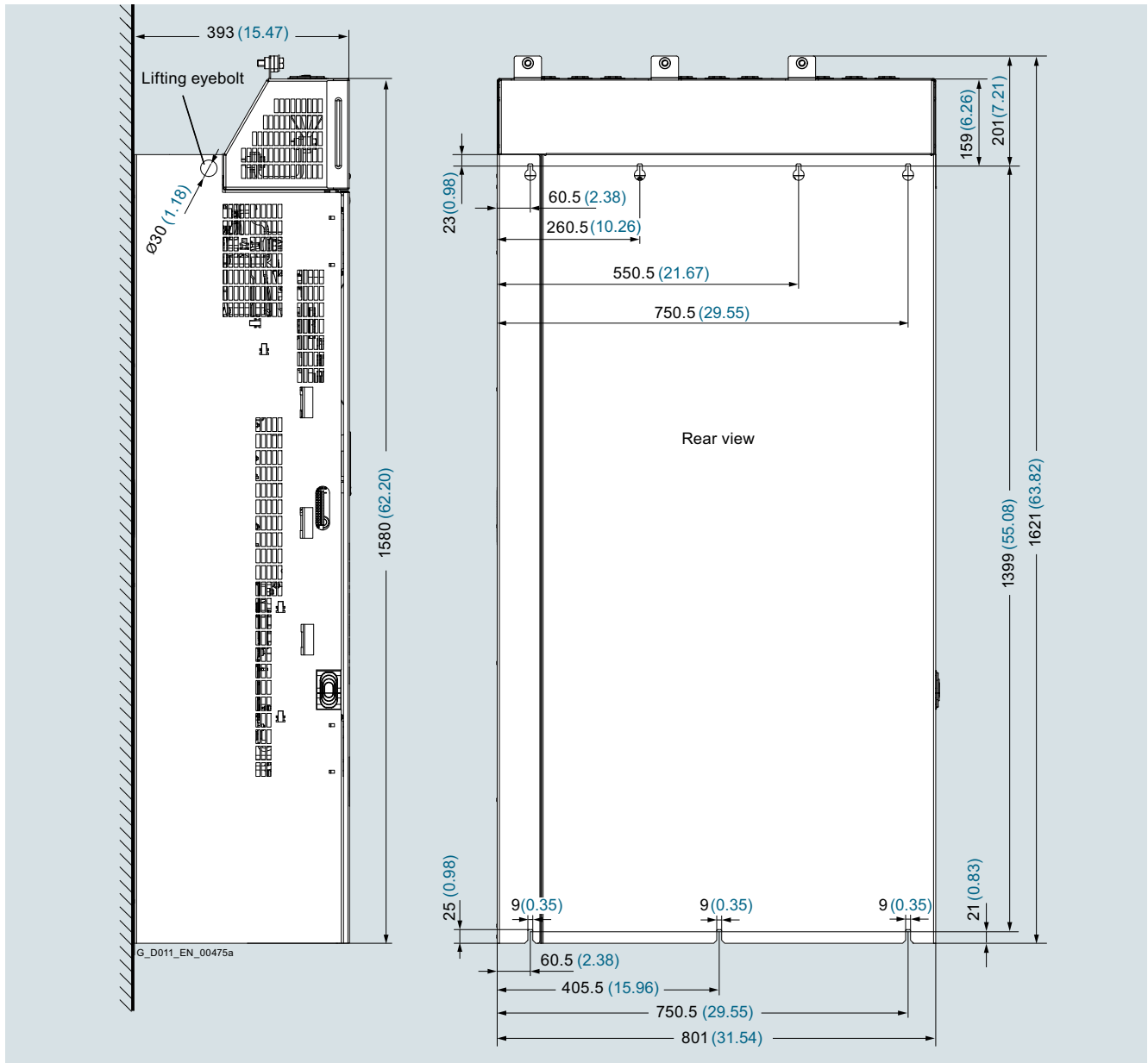

Principle dimension drawing and drill pattern for PM330 Power Modules, frame size JX

Secured with M8 bolts

Ventilation clearance required at the top: 200 mm (7.87 in)

Ventilation clearance required at the bottom: 250 mm (9.84 in)

Ventilation clearance required at sides: 30 mm (1.18 in)

Ventilation clearance required at front: 100 mm (3.94 in)

PM330 Power Modules are designed for installation in a control cabinet.

All dimensions in mm (values in brackets are in inches).

SINAMICS G120P built-in and wall-mounted units

PM330 Power Modules, 160 kW to 630 kW

Line filters

Overview



Line filter for Power Modules, frame size GX

To limit the emitted interference, the converters are equipped as standard with a radio interference suppression filter that conforms to the limits defined in Category C3. Equipped with an additional line filter, the PM330 Power Module also meet the limits for use in the first environment (Category C2) as specified in EN 61800-3¹⁾.

The PM330 Power Modules comply with the immunity requirements defined in EN 61800-3 as standard for the second environment.

In conjunction with line reactors, line filters also limit the conducted interference emitted by the Power Modules to the limit values of Category C2 defined in product standard EN 61800-3. When combined with a plant design rigorously based on the EMC installation guidelines, the limit values at the installation site will conform to the requirements for the first environment.

The line filters are suitable for grounded systems (TN or TT systems with grounded neutral point).

Selection and ordering data

Rated power 400 V/ 690 V	460 V/ 575 V	SINAMICS G120P, PM330 Power Modules		Line filter in accordance with EN 61800-3 Category C2
kW	hp	Type 6SL3310-...	Frame size	Article No.
380 ... 480 V 3 AC				
160	200	1PE33-0AA0	GX	6SL3000-0BE33-1AA0
200	250	1PE33-7AA0		
250	300	1PE34-6AA0		6SL3000-0BE35-0AA0
315	400	1PE35-8AA0	HX	6SL3760-0MR00-0AA0
355	450	1PE36-6AA0		
400	500	1PE37-4AA0		
450	500	1PE38-4AA0	JX	6SL3760-0MR00-0AA0
500	600	1PE38-8AA0		
560	700	1PE41-0AA0		
500 ... 690 V 3 AC				
315	350	1PG33-7AA0	HX	6SL3760-0MS00-0AA0
355	400	1PG34-0AA0		
400	450	1PG34-5AA0		
450	450	1PG35-2AA0		
500	500	1PG35-8AA0	JX	6SL3760-0MS00-0AA0
560	600	1PG36-5AA0		
630	700	1PG37-2AA0		

¹⁾ Applies to shielded motor cable lengths of up to 150 m (492 ft).

SINAMICS G120P built-in and wall-mounted units

PM330 Power Modules, 160 kW to 630 kW

Line filters

Technical specifications

Line voltage 380 ... 480 V 3 AC		Line filter		
		6SL3000-0BE33-1AA0	6SL3000-0BE35-0AA0	6SL3760-0MR00-0AA0
Rated current	A	400	600	1200
Power loss	kW	0.047	0.06	0.106
Line supply connection L1, L2, L3		Connecting lugs for M10, provided for busbar connection	Connecting lugs for M10, provided for busbar connection	Connecting lugs for M12, provided for busbar connection
Load connection L1', L2', L3'		Connecting lugs for M10, provided for busbar connection	Connecting lugs for M10, provided for busbar connection	Connecting lugs for M12, provided for busbar connection
PE connection		Hole for M8	Hole for M10	Hole for M12
Degree of protection		IP00	IP00	IP00
Dimensions				
• Width	mm (in)	360 (14.2)	390 (15.4)	425 (16.7)
• Height	mm (in)	240 (9.45)	265 (10.4)	265 (10.4)
• Depth	mm (in)	116 (4.57)	140 (5.51)	148 (5.83)
Weight, approx.	kg (lb)	12.7 (28.0)	19.9 (43.9)	25 (55.1)
Suitable for PM330 Power Module		6SL3310-1PE33-0AA0 6SL3310-1PE33-7AA0	6SL3310-1PE34-6AA0	HX: 6SL3310-1PE35-8AA0 6SL3310-1PE36-6AA0 6SL3310-1PE37-4AA0 JX: 6SL3310-1PE38-4AA0 6SL3310-1PE38-8AA0 6SL3310-1PE41-0AA0
• Frame size		GX	GX	HX/JX

Line voltage 500 ... 690 V 3 AC		Line filter		
		6SL3760-0MS00-0AA0		
Rated current	A	1200		
Power loss	kW	0.112		
Line supply connection L1, L2, L3		Connecting lugs for M12, provided for busbar connection		
Load connection L1', L2', L3'		Connecting lugs for M12, provided for busbar connection		
PE connection		Hole for M12		
Degree of protection		IP00		
Dimensions				
• Width	mm (in)	425 (16.7)		
• Height	mm (in)	265 (10.4)		
• Depth	mm (in)	154 (6.06)		
Weight, approx.	kg (lb)	25 (55.1)		
Suitable for PM330 Power Module		HX: 6SL3310-1PG33-7AA0 6SL3310-1PG34-0AA0 6SL3310-1PG34-5AA0 6SL3310-1PG35-2AA0 JX: 6SL3310-1PG35-8AA0 6SL3310-1PG36-5AA0 6SL3310-1PG37-2AA0		
• Frame size		HX/JX		

SINAMICS G120P built-in and wall-mounted units

PM330 Power Modules, 160 kW to 630 kW

Line reactors

Overview

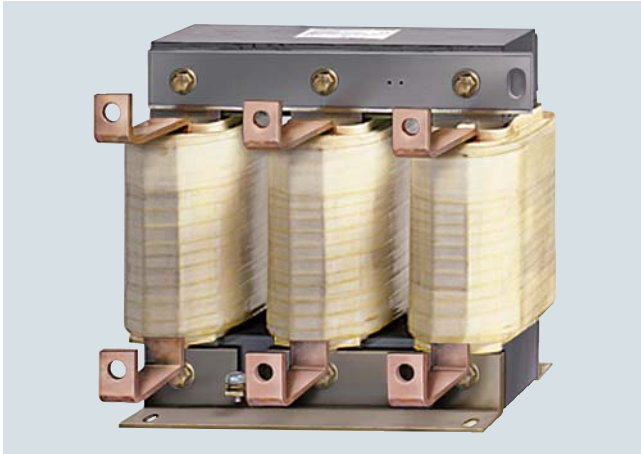

Line reactor

A line reactor is needed for high short-circuit power levels, partly to protect the actual converter against excessive harmonic currents, and thus against overload, and partly to limit line harmonics to the permitted values. The harmonic currents are limited by the total inductance comprising the line reactor and mains supply cable inductance. Line reactors can be omitted if the mains supply cable inductance is increased sufficiently, i.e., the value of R_{SC} must be sufficiently small.

R_{SC} = Relative Short-Circuit power: Ratio of short-circuit power $S_{k\text{ Line}}$ at the supply connection point to the fundamental apparent power S_{conv} of the connected converters (to IEC 60146-1-1).

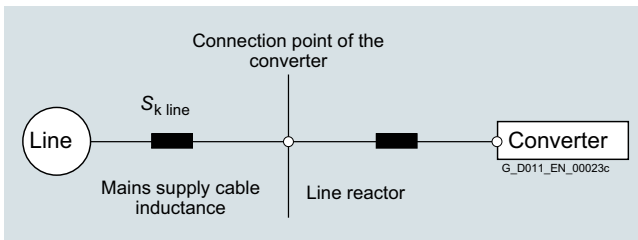

PM330 Power Module requirements:

Power kW	Line reactor can be omitted for R_{SC}	Line reactor required for R_{SC}
<200	≤ 43	> 43
200 ... 500	≤ 33	> 33
>500	≤ 20	> 20

It is recommended that a line reactor is always connected on the line side of the converter, as in practice, it is often not known on which supply configuration individual converters are to be operated, i.e. which supply short-circuit power is present at the converter connection point.

A line reactor can only be dispensed with when the value for R_{SC} is less than that in the above table. This is the case, when the converter, as shown in the following figure, is connected to the line through a transformer with the appropriate rating.

Notice:

A line reactor is always needed if a line filter is used.

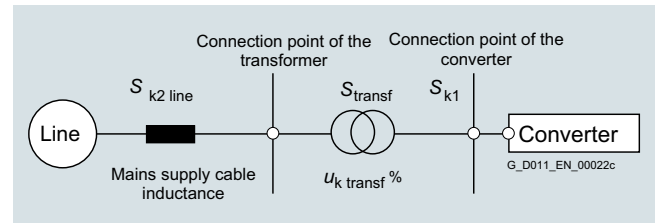

In this case, the line short-circuit power S_{k1} at the connection point of the converter is approximately:

$$S_{k1} = S_{transf} / (u_{k\text{ transf}} + S_{transf} / S_{k2\text{ line}})$$

$$S_{transf} = \text{Transformer rated power}$$

$$S_{k2\text{ line}} = \text{Short-circuit power of the higher-level voltage level}$$

$$u_{k\text{ transf}} = \text{Relative short-circuit voltage}$$

SINAMICS G120P built-in and wall-mounted units

PM330 Power Modules, 160 kW to 630 kW

Line reactors

Selection and ordering data

Rated power		SINAMICS G120P, PM330 Power Modules		Line reactor
400 V/690 V	460 V/575 V	Type 6SL3310-...	Frame size	Article No.
kW	hp			
380 ... 480 V 3 AC				
160	200	1PE33-0AA0	GX	6SL3000-0CE33-3AA0
200	250	1PE33-7AA0		6SL3000-0CE35-1AA0
250	300	1PE34-6AA0		
315	400	1PE35-8AA0	HX	6SL3000-0CE36-3AA0
355	450	1PE36-6AA0		6SL3000-0CE37-7AA0
400	500	1PE37-4AA0		
450	500	1PE38-4AA0	JX	6SL3000-0CE38-7AA0
500	600	1PE38-8AA0		6SL3000-0CE41-0AA0
560	700	1PE41-0AA0		
500 ... 690 V 3 AC				
315	350	1PG33-7AA0	HX	6SL3000-0CH34-8AA0
355	400	1PG34-0AA0		
400	450	1PG34-5AA0		
450	450	1PG35-2AA0	HX	6SL3000-0CH36-0AA0
500	500	1PG35-8AA0	JX	6SL3000-0CH36-0AA0
560	600	1PG36-5AA0		6SL3000-0CH38-4AA0
630	700	1PG37-2AA0		

Technical specifications

Line voltage 380 ... 480 V 3 AC		Line reactor			
		6SL3000-0CE33-3AA0	6SL3000-0CE35-1AA0	6SL3000-0CE36-3AA0	6SL3000-0CE37-7AA0
$I_{th\ max}$	A	331	508	628	773
Nominal inductance L_{rated}	μ H	52	42	27	22
Power loss	kW	0.267	0.365	0.368	0.351
Line supply connection 1U1, 1V1, 1W1		1 × hole for M10, provided for busbar connection	1 × hole for M12, provided for busbar connection	1 × hole for M12, provided for busbar connection	1 × hole for M12, provided for busbar connection
Load connection 1U2, 1V2, 1W2		1 × hole for M10, provided for busbar connection	1 × hole for M12, provided for busbar connection	1 × hole for M12, provided for busbar connection	1 × hole for M12, provided for busbar connection
PE connection		M6 screw	M6 screw	M6 screw	M6 screw
Degree of protection		IP00	IP00	IP00	IP00
Dimensions					
• Width	mm (in)	270 (10.6)	300 (11.8)	300 (11.8)	300 (11.8)
• Height	mm (in)	248 (9.76)	269 (10.6)	269 (10.6)	269 (10.6)
• Depth	mm (in)	200 (7.87)	212 (8.35)	212 (8.35)	212 (8.35)
Weight, approx.	kg (lb)	27.8 (61.3)	38 (83.8)	41.4 (91.3)	51.3 (113)
Suitable for PM330 Power Module	Type	6SL3310-1PE33-0AA0	6SL3310-1PE33-7AA0 6SL3310-1PE34-6AA0	6SL3310-1PE35-8AA0	6SL3310-1PE36-6AA0 6SL3310-1PE37-4AA0
• Frame size		GX	GX	HX	HX

4

SINAMICS G120P built-in and wall-mounted units

PM330 Power Modules, 160 kW to 630 kW

Line reactors

Technical specifications (continued)

Line voltage 380 ... 480 V 3 AC		Line reactor	
		6SL3000-OCE38-7AA0	6SL3000-OCE41-0AA0
$I_{th\ max}$	A	871	1060
Nominal inductance L_{rated}	μH	19	16
Power loss	kW	0.458	0.498
Line supply connection 1U1, 1V1, 1W1		1 × hole for M12, provided for busbar connection	1 × hole for M12, provided for busbar connection
Load connection 1U2, 1V2, 1W2		1 × hole for M12, provided for busbar connection	1 × hole for M12, provided for busbar connection
PE connection		M6 screw	M6 screw
Degree of protection		IP00	IP00
Dimensions			
• Width	mm (in)	350 (13.8)	350 (13.8)
• Height	mm (in)	321 (12.6)	321 (12.6)
• Depth	mm (in)	211.5 (8.33)	211.5 (8.33)
Weight, approx.	kg (lb)	63.2 (139)	69.6 (153)
Suitable for PM330 Power Module	Type	6SL3310-1PE38-4AA0	6SL3310-1PE38-8AA0 6SL3310-1PE41-0AA0
• Frame size		JX	JX

Line voltage 500 ... 690 V 3 AC		Line reactor		
		6SL3000-0CH34-8AA0	6SL3000-0CH36-0AA0	6SL3000-0CH38-4AA0
$I_{th\ max}$	A	482	597	840
Nominal inductance L_{rated}	μH	65	46	40
Power loss	kW	0.478	0.458	0.618
Line supply connection 1U1, 1V1, 1W1		1 × hole for M10, provided for busbar connection	1 × hole for M12, provided for busbar connection	1 × hole for M12, provided for busbar connection
Load connection 1U2, 1V2, 1W2		1 × hole for M10, provided for busbar connection	1 × hole for M12, provided for busbar connection	1 × hole for M12, provided for busbar connection
PE connection		M6 screw	M6 screw	M6 screw
Degree of protection		IP00	IP00	IP00
Dimensions				
• Width	mm (in)	350 (13.8)	350 (13.8)	410 (16.1)
• Height	mm (in)	321 (12.6)	321 (12.6)	385 (15.2)
• Depth	mm (in)	232.5 (9.15)	232.5 (9.15)	224 (8.82)
Weight, approx.	kg (lb)	55.6 (123)	63.8 (141)	98 (216)
Suitable for PM330 Power Module	Type	6SL3310-1PG33-7AA0 6SL3310-1PG34-0AA0 6SL3310-1PG34-5AA0	HX: 6SL3310-1PG35-2AA0 JX: 6SL3310-1PG35-8AA0	6SL3310-1PG36-5AA0 6SL3310-1PG37-2AA0
• Frame size		HX	HX/JX	JX

SINAMICS G120P built-in and wall-mounted units PM330 Power Modules, 160 kW to 630 kW

Recommended line-side power components

Selection and ordering data

Overcurrent protection devices are absolutely necessary for the operation of the converters. The table below lists recommended ratings for input-end switching and fuse protection elements for compliance with IEC standards.

Notes for use in compliance with IEC standards:

3NA3 or 3NE1 Siemens fuses are recommended for European countries.

Notes for use in compliance with UL regulations:

UL-approved fuses must be used in North America.

Notes regarding installations in Canada:

Overvoltage protection devices in accordance with overvoltage category III and with the following ratings must be connected on the line side of the converter:

- Rated voltage 480 V/600 V (phase-phase), 480 V/600 V (phase-to-ground) at a rated line voltage of 480 V/600 V
- Voltage limit 4 kV (phase-phase) and 6 kV (phase-ground)

All overvoltage protection devices used must comply with Canadian standards for industrial installations.

Additional information about the listed Siemens fuses can be found in Catalogs LV 10, IC 10 and IC 10 AO as well as in the Industry Mall.

Rated power ¹⁾		SINAMICS G120 PM330 Power Modules		Main contactor acc. to IEC	Switch disconnector acc. to IEC		Cable protection fuse incl. semiconductor protection ²⁾ acc. to IEC			Cable protection fuse acc. to IEC			Cable protection fuse incl. semiconductor protection acc. to UL/cUL		
400 V / 690 V	460 V / 575 V	Type		Type	Rated current	Type	Rated current	Minimum short-circuit current	Article No.	Rated current	Minimum short-circuit current	Article No.	Rated current	Article No.	
kW	hp	6SL3310-...	Frame size	Type	A	Type	A	A		A	A		A	Article No.	
380 ... 480 V 3 AC															
160	200	1PE33-0AA0	GX	3RT1456 2 units	400	3KL5730	450	3500	3NE1333-2	400	9500	3NA3260	450	3NE1333-2	
200	250	1PE33-7AA0	GX	3RT1456 2 units	400	3KL5730	500	4500	3NE1334-2	500	14000	3NA3365	500	3NE1334-2	
250	300	1PE34-6AA0	GX	3RT1456 3 units	630	3KL6130	560	7000	3NE1435-2	630	20000	3NA3372	560	3NE1435-2	
315	400	1PE35-8AA0	HX	3RT1456 3 units	630	3KL6130	710	10000	3NE1437-2				710	3NE1437-2	
355	450	1PE36-6AA0	HX	3RT1466 2 units	800	3KL6230	800	11000	3NE1438-2	800	30000	3NA3475	800	3NE1438-2	
400	500	1PE37-4AA0	HX	3RT1466 3 units	800	3KL6230	850	13000	3NE1448-2				850	3NE1448-2	
450	500	1PE38-4AA0	JX	3RT1466 3 units	1000	3KD5034	2 × 500	10400	3NE1334-3 2 units	1000	40000	3NA3480	1000	3NB3350-1KK26	
500	600	1PE38-8AA0	JX	3RT1466 3 units	1000	3KD5034	2 × 560	14000	3NE1435-3 2 units	1000	40000	3NA3480	1100	3NB3351-1KK26	
560	700	1PE41-0AA0	JX	3RT1476 2 units	1250	3KD5234	2 × 630	16000	3NE1436-3 2 units	1250	52000	3NA3482	1250	3NB3352-1KK26	
500 ... 690 V 3 AC															
315	350	1PG33-7AA0	HX	3RT1476	400	3KL5730	450	3500	3NE1333-2	400	10000	3NA3360-6	450	3NE1333-2	
355	400	1PG34-0AA0	HX	3RT1476	630	3KL6130	500	4500	3NE1334-2	425	10500	3NA3362-6	500	3NE1334-2	
400	450	1PG34-5AA0	HX	3RT1476	630	3KL6130	560	7000	3NE1435-2	500	13000	3NA3365-6	560	3NE1435-2	
450	450	1PG35-2AA0	HX	3RT1476	630	3KL6130	630	8500	3NE1436-2	2 × 315	14600	3NA3352-6 2 units	630	3NE1436-2	
500	500	1PG35-8AA0	JX	3RT1466 3 units	630	3KD4634	710	10000	3NE1437-2	2 × 355	16000	3NA3354-6 2 units	710	3NE1437-2	
560	600	1PG36-5AA0	JX	3RT1466 3 units	800	3KD4834	800	11000	3NE1438-2	2 × 400	20000	3NA3360-6 2 units	800	3NE1438-2	
630	700	1PG37-2AA0	JX	3RT1466 3 units	1000	3KD5034	850	13000	3NE1448-2	2 × 425	21000	3NA3362-6 2 units	850	3NE1448-2	

Note:

Important! Note the minimum short-circuit current required to trip the protection devices. If the minimum short-circuit current is not reached, the tripping time of the fuses is increased, which can lead to damage.

¹⁾ Rated power based on the rated output current I_{rated} .

²⁾ Suitable for 3KL/3KD switch disconnector.

SINAMICS G120P built-in and wall-mounted units

PM330 Power Modules, 160 kW to 630 kW

Braking Modules

Overview



Braking Module

A Braking Module and the matching braking resistor are needed by the drive when it brakes or needs to be stopped for a specific reason, e.g. for an EMERGENCY STOP. Large fans which are caused to rotate by air flow are a typical application. In such instances, it is important to consider operating states which could result in speeds in excess of the desired maximum speed but also the possibility of reversal of rotational direction during restart from standstill. A braking unit is also required if the fan must be brought to a standstill within a defined time period.

The Braking Module houses the power electronics and the associated control circuit. The supply voltage for the electronics is taken from the DC link.

During operation, the DC link power is converted into heat loss in an external braking resistor.

The activation threshold of the Braking Module can be adjusted by means of a switch. The braking power values indicated in the technical specifications apply to the upper activation threshold:

Design

The Braking Module is designed for installation in the control cabinet. It must always be mounted vertically.

A Braking Module is assigned its own dedicated braking resistor. The Braking Module is connected to the DC link by means of flexible cables.

The Braking Module has the following interfaces as standard:

- DC link connection
- Connection for braking resistor
- 1 digital input (inhibit Braking Module/reset error)
- 1 digital output (Braking Module faulty/ready)

A switch is provided for adjusting the activation threshold.

Integration

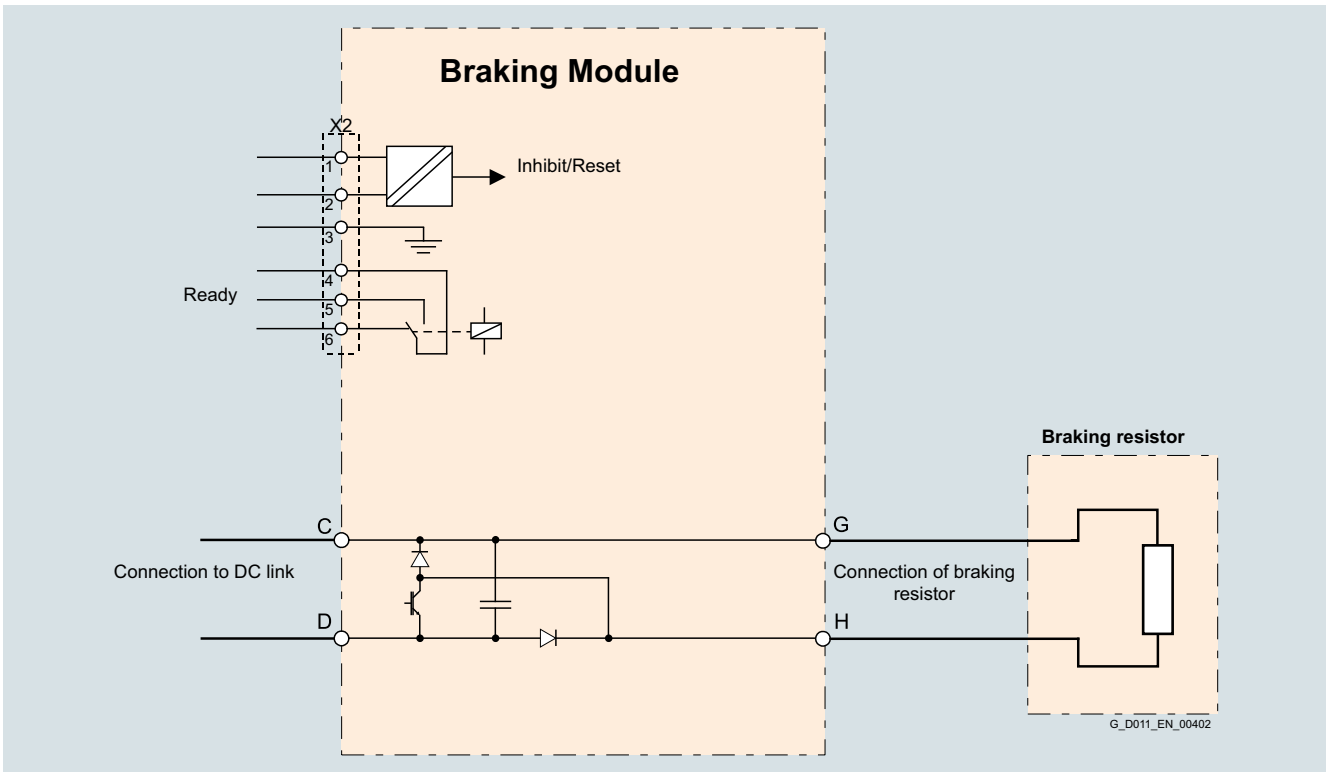

Connection example of a Braking Module

SINAMICS G120P built-in and wall-mounted units

PM330 Power Modules, 160 kW to 630 kW

Braking Modules

Selection and ordering data

Rated power		SINAMICS G120P PM330 Power Modules		Braking Module
400 V kW	460 V hp	Type 6SL3310-...	Frame size	Article No.
380 ... 480 V 3 AC				
160	200	1PE33-0AA0	GX	6SL3760-1AE32-6AA0
200	250	1PE33-7AA0		
250	300	1PE34-6AA0		
315	400	1PE35-8AA0	HX	
355	450	1PE36-6AA0		
400	500	1PE37-4AA0		
450	500	1PE38-4AA0	JX	
500	600	1PE38-8AA0		
560	700	1PE41-0AA0		

Technical specifications

Line voltage 380 ... 480 V 3 AC	Braking Module
	6SL3760-1AE32-6AA0
Rated power P_{DB} (Continuous braking power)	50 kW
Power P_{20}	200 kW
Braking current for P_{DB}	65 A
Activation thresholds (adjustable via switch)	670 V / 770 V (factory setting)
Connectable resistance for P_{DB}	3.1 Ω
Digital input	
• Voltage	24 V
• Low level (an open digital input is interpreted as "low")	<3 V
• High level	<7 V
• Current consumption at 24 V DC, typ.	0.01 mA
• Conductor cross-section, max.	2.5 mm ²
Digital output	
• AC voltage, max.	250 V
• Load current per digital output, max.	2 A
• Conductor cross-section, max.	2.5 mm ²
Power loss, max.	0.1 kW
Braking resistor connection	Screw-type terminal
• Conductor cross-section, max.	35 mm ²
• Cable length, max.	100 m (328 ft)
DC link connection	Screw-type terminal
• Conductor cross-section, max.	35 mm ²
• Cable length, max.	3 m (9.84 ft)
Degree of protection	IP20
Dimensions	
• Width	180 mm (7.09 in)
• Height	220 mm (8.66 in)
• Depth	152 mm (5.98 in)
Weight, approx.	5.5 kg (12.1 lb)

Characteristic curves

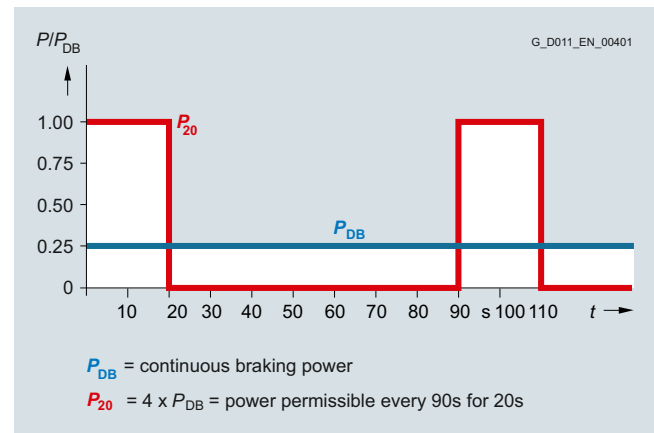

Load diagram for Braking Modules and braking resistor

SINAMICS G120P built-in and wall-mounted units

PM330 Power Modules, 160 kW to 630 kW

Braking resistors

Overview



Braking resistor

Excess energy in the DC link is dissipated in the braking resistor.

The braking resistor is connected to the Braking Module. The braking resistor is positioned outside the cabinet or switchgear room. This enables the resulting heat loss to be removed from the area of the Power Modules. The level of air conditioning required is therefore reduced.

A temperature switch (NC contact) is fitted. This responds when the maximum permissible temperature is exceeded and can be evaluated by a controller. The maximum permissible cable length between the Braking Module and braking resistor is 100 m (328 ft).

Selection and ordering data

Rated power P_{DB} kW	Braking Module	Braking resistor Article No.
380 ... 480 V 3 AC		
50	6SL3760-1AE32-6AA0	6SE3760-5FS87-2DC0

Technical specifications

Line voltage 380 V ... 480 V 3 AC	Braking resistor 6SE3760-5FS87-2DC0
Resistance	3.1 Ω (\pm 10 %)
Rated power P_{DB} (Continuous braking power)	50 kW
Power P_{20}	200 kW
Current, max.	378 A
Cable connections	M12 stud
• Power cable, max.	70 mm ²
• PE/GND, max.	50 mm ²
Cable length to Braking Module, max.	\leq 100 m (328 ft)
Degree of protection	IP20
Dimensions	
• Width	740 mm (29.1 in)
• Height	1325 mm (52.2 in)
• Depth	485 mm (19.1 in)
Weight, approx.	109 kg (240 lb)
Suitable for Braking Module	6SL3760-1AE32-6AA0

Characteristic curves

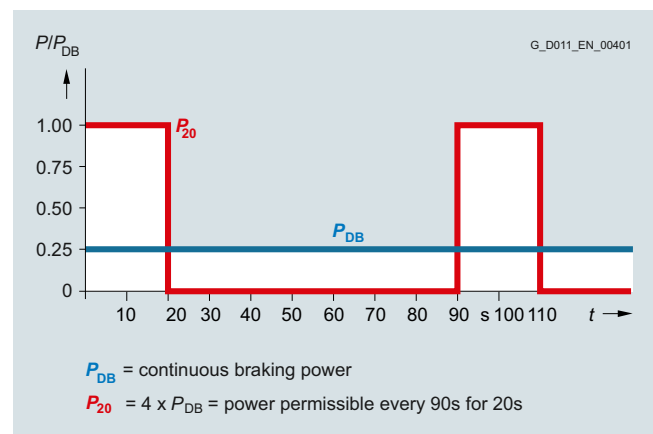

Load diagram for Braking Modules and braking resistor

SINAMICS G120P built-in and wall-mounted units

PM330 Power Modules, 160 kW to 630 kW

Output reactors

Overview

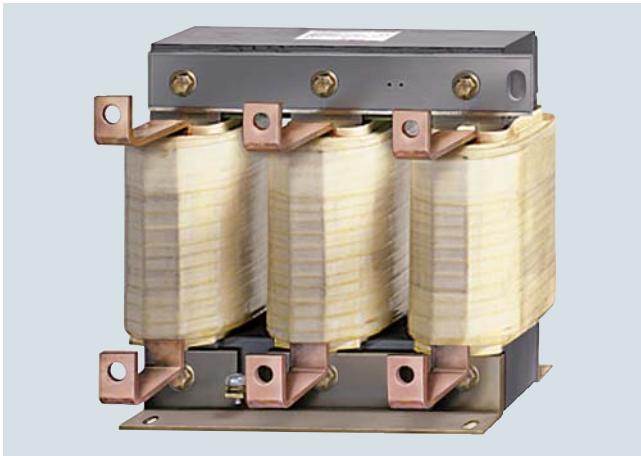

Output reactor

Output reactors reduce the rate of voltage rise (dv/dt) and the height of the current peaks, and enable longer motor cables to be connected.

Owing to the high rates of voltage rise of the fast-switching IGBTs, the capacitance of long motor cables reverses polarity very quickly with every switching operation in the converter. As a result, the motor is loaded with additional current peaks of substantial magnitude.

Output reactors reduce the magnitude of these additional peaks because the cable capacitance reverses polarity more slowly across the reactor inductance, thereby attenuating the amplitudes of the current peaks.

When using output reactors, the following should be observed:

- The output reactor must be installed as close as possible to the Power Module.

Selection and ordering data

Rated power		SINAMICS G120 PM330 Power Modules		Output reactor	
400 V/ 690 V	460 V/ 575 V	Type 6SL3310-...	Frame size	Article No.	
kW	hp				
380 ... 480 V 3 AC					
160	200	1PE33-0AA0	GX	6SL3000-2BE33-2AA0	
200	250	1PE33-7AA0	GX	6SL3000-2BE33-8AA0	
250	300	1PE34-6AA0	GX	6SL3000-2BE35-0AA0	
315	400	1PE35-8AA0	HX	6SL3000-2AE36-1AA0	
355	450	1PE36-6AA0	HX	6SL3000-2AE38-4AA0	
400	500	1PE37-4AA0			
450	500	1PE38-4AA0	JX	6SL3000-2AE41-0AA0	
500	600	1PE38-8AA0			
560	700	1PE41-0AA0		6SL3000-2AE41-4AA0	
500 ... 690 V 3 AC					
315	350	1PG33-7AA0	HX	6SL3000-2AH34-7AA0	
355	400	1PG34-0AA0			
400	450	1PG34-5AA0	HX	6SL3000-2AH35-8AA0	
450	450	1PG35-2AA0	HX	6SL3000-2AH38-1AA0	
500	500	1PG35-8AA0	JX	6SL3000-2AH38-1AA0	
560	600	1PG36-5AA0			
630	700	1PG37-2AA0			

Technical specifications

Line voltage 380 ... 480 V 3 AC		Output reactor				
		6SL3000- 2BE33-2AA0	6SL3000- 2BE33-8AA0	6SL3000- 2BE35-0AA0	6SL3000- 2AE36-1AA0	6SL3000- 2AE38-4AA0
Rated current	A	310	380	490	605	840
Power loss	kW	0.422	0.447	0.448	0.798	0.834
Connection						
• To Power Module		1 × hole for M10	1 × hole for M10	1 × hole for M12	1 × hole for M12	1 × hole for M12
• To load		1 × hole for M10	1 × hole for M10	1 × hole for M12	1 × hole for M12	1 × hole for M12
• PE		M8 screw	M8 screw	M8 screw	M10 screw	M10 screw
Cable length, max. between output reactor and motor						
• Shielded	m (ft)	300 (984)	300 (984)	300 (984)	300 (984)	300 (984)
• Unshielded	m (ft)	450 (1476)	450 (1476)	450 (1476)	450 (1476)	450 (1476)
Dimensions						
• Width	mm (in)	300 (11.8)	300 (11.8)	300 (11.8)	410 (16.1)	410 (16.1)
• Height	mm (in)	285 (11.2)	285 (11.2)	365 (14.4)	392 (15.4)	392 (15.4)
• Depth	mm (in)	257 (10.1)	277 (10.9)	277 (10.9)	292 (11.5)	292 (11.5)
Degree of protection		IP00	IP00	IP00	IP00	IP00
Weight, approx.	kg (lb)	62 (137)	73 (161)	100 (220)	130 (287)	140 (309)
Suitable for PM330 Power Module	Type	6SL3310- 1PE33-0AA0	6SL3310- 1PE33-7AA0	6SL3310- 1PE34-6AA0	6SL3310- 1PE35-8AA0	6SL3310- 1PE36-6AA0 6SL3310- 1PE37-4AA0
• Frame size		GX	GX	GX	HX	HX

SINAMICS G120P built-in and wall-mounted units

PM330 Power Modules, 160 kW to 630 kW

Output reactors

Technical specifications (continued)

Line voltage 380 ... 480 V 3 AC		Output reactor	
		6SL3000-2AE41-0AA0	6SL3000-2AE41-4AA0
Rated current	A	985	1405
Power loss	kW	0.939	0.81
Connection			
• To Power Module		1 × hole for M12	2 × hole for M12
• To load		1 × hole for M12	2 × hole for M12
• PE		M10 screw	M10 screw
Cable length, max. between output reactor and motor			
• Shielded	m (ft)	300 (984)	300 (984)
• Unshielded	m (ft)	450 (1476)	450 (1476)
Dimensions			
• Width	mm (in)	410 (16.1)	460 (18.1)
• Height	mm (in)	392 (15.4)	392 (15.4)
• Depth	mm (in)	302 (11.9)	326 (12.8)
Degree of protection		IP00	IP00
Weight, approx.	kg (lb)	146 (322)	179 (395)
Suitable for PM330 Power Module		Type	6SL3310-1PE38-4AA0 6SL3310-1PE38-8AA0
• Frame size		JX	6SL3310-1PE41-0AA0 JX

Line voltage 500 ... 690 V 3 AC		Output reactor		
		6SL3000-2AH34-7AA0	6SL3000-2AH35-8AA0	6SL3000-2AH38-1AA0
Rated current	A	465	575	810
Power loss	kW	0.631	0.705	0.79
Connection				
• To Power Module		1 × hole for M12	1 × hole for M12	1 × hole for M12
• To load		1 × hole for M12	1 × hole for M12	1 × hole for M12
• PE		M8 screw	M8 screw	M8 screw
Cable length, max. between output reactor and motor				
• Shielded	m (ft)	300 (984)	300 (984)	300 (984)
• Unshielded	m (ft)	450 (1476)	450 (1476)	450 (1476)
Dimensions				
• Width	mm (in)	410 (16.1)	410 (16.1)	410 (16.1)
• Height	mm (in)	392 (15.4)	392 (15.4)	392 (15.4)
• Depth	mm (in)	279 (11.0)	279 (11.0)	279 (11.0)
Degree of protection		IP00	IP00	IP00
Weight, approx.	kg (lb)	80 (176)	80 (176)	146 (322)
Suitable for PM330 Power Module		Type	6SL3310-1PG33-7AA0 6SL3310-1PG34-0AA0	HX: 6SL3310-1PG35-2AA0 JX: 6SL3310-1PG35-8AA0 6SL3310-1PG36-5AA0 6SL3310-1PG37-2AA0
• Frame size		HX	HX	HX/JX

SINAMICS G120P built-in and wall-mounted units

PM330 Power Modules, 160 kW to 630 kW

dv/dt filters plus VPL

Overview

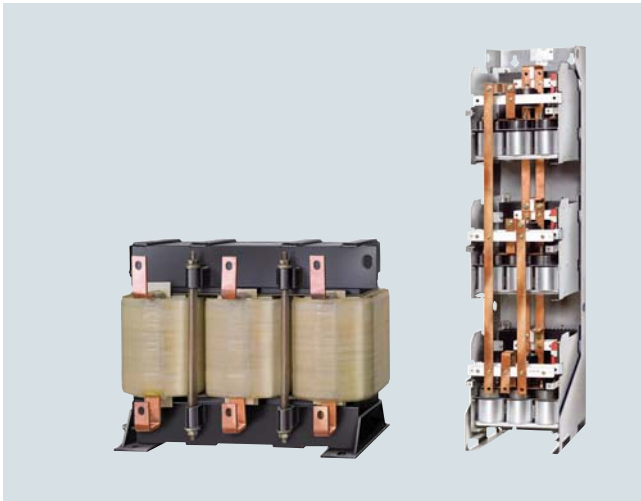

dv/dt filter plus VPL (**V**oltage **P**eak **L**imiter) limit the voltage rate-of-rise dv/dt to values $< 500 \text{ V}/\mu\text{s}$ and the typical voltage peaks to the following values according to the limit value curve to IEC/TS 60034-17: 2006:

- $< 1000 \text{ V}$ at $U_{\text{line}} < 575 \text{ V}$
- $< 1250 \text{ V}$ at $660 \text{ V} < U_{\text{line}} < 690 \text{ V}$

Standard motors with standard insulation and without insulated bearings can be used for converter operation if a dv/dt filter plus VPL is used.

The dv/dt filter plus VPL are designed for the following maximum motor cable lengths:

- Shielded cables: 300 m (984 ft) (e.g. Protodur NYCWY)
- Unshielded cables: 450 m (1476 ft) (e.g. Protodur NYY)

For shorter cable lengths (100 m (328 ft) shielded, 150 m (492 ft) unshielded) also refer to dv/dt filter compact plus VPL.

Note:

The maximum permissible cable length between the dv/dt filter and Power Module is 5 m (16.41 ft).

Design

The dv/dt filter plus VPL consists of two components, which are also separately supplied as mechanical units:

- dv/dt reactor
- Voltage limiting network, which cuts off the voltage peaks and feeds the energy back into the DC link.

Selection and ordering data

Rated power		SINAMICS G120 PM330 Power Module		dv/dt filter plus VPL	
400 V/ 690 V	460 V/ 575 V	Type 6SL3310-...	Frame size	Article No.	
kW	hp				
380 ... 480 V 3 AC					
160	200	1PE33-0AA0	GX	6SL3000-2DE35-0AA0	
200	250	1PE33-7AA0			
250	300	1PE34-6AA0			
315	400	1PE35-8AA0	HX	6SL3000-2DE38-4AA0	
355	450	1PE36-6AA0			
400	500	1PE37-4AA0			
450	500	1PE38-4AA0	JX	6SL3000-2DE41-4AA0	
500	600	1PE38-8AA0			
560	700	1PE41-0AA0			
500 ... 690 V 3 AC					
315	350	1PG33-7AA0	HX	6SL3000-2DH35-8AA0	
355	400	1PG34-0AA0			
400	450	1PG34-5AA0			
450	450	1PG35-2AA0	HX	6SL3000-2DH38-1AA0	
500	500	1PG35-8AA0	JX	6SL3000-2DH38-1AA0	
560	600	1PG36-5AA0			
630	700	1PG37-2AA0			

SINAMICS G120P built-in and wall-mounted units

PM330 Power Modules, 160 kW to 630 kW

dv/dt filters plus VPL

Technical specifications

Line voltage 380 ... 480 V 3 AC		dv/dt filter plus VPL		
		6SL3000-2DE35-0AA0	6SL3000-2DE38-4AA0	6SL3000-2DE41-4AA0 ¹⁾
I_{th max}	A	490	840	1450
Degree of protection		IP00	IP00	IP00
Cable length, max. between dv/dt filter and motor				
• Shielded	m (ft)	300 (984)	300 (984)	300 (984)
• Unshielded	m (ft)	450 (1476)	450 (1476)	450 (1476)
Conformity		CE	CE	CE
Certificates of suitability, according to		cURus	cURus	cURus
dv/dt reactor				
Power loss, max.				
• At 50 Hz	kW	0.874	1.106	1.111
• At 60 Hz	kW	0.904	1.115	1.154
Connections				
• To Power Module		1 × hole for M12	1 × hole for M12	1 × hole for M12
• To load		1 × hole for M12	1 × hole for M12	1 × hole for M12
• PE		M6 screw	M6 screw	M6 screw
Dimensions				
• Width	mm (in)	460 (18.1)	460 (18.1)	445 (17.5)
• Height	mm (in)	370 (14.6)	385 (15.2)	385 (15.2)
• Depth	mm (in)	275 (10.8)	312 (12.3)	312 (12.3)
Weight, approx.	kg (lb)	122 (269)	149 (328)	158 (348)
Voltage Peak Limiter (VPL)				
Power loss, max.				
• At 50 Hz	kW	0.042	0.077	0.134
• At 60 Hz	kW	0.039	0.072	0.125
Connections				
• To dv/dt reactor		70 mm ² terminals	1 × hole for M8	1 × hole for M10
• To DC link		70 mm ² terminals	1 × hole for M8	1 × hole for M10
• PE		35 mm ² terminals	M8 stud	M8 stud
Dimensions				
• Width	mm (in)	392 (15.4)	309 (12.2)	309 (12.2)
• Height	mm (in)	285 (11.2)	1312.5 (51.7)	1312.5 (51.7)
• Depth	mm (in)	210 (8.27)	400 (15.7)	400 (15.7)
Weight, approx.	kg (lb)	16 (35.3)	48 (106)	72 (159)
Suitable for PM330 Power Module		6SL3310-1PE33-0AA0 6SL3310-1PE33-7AA0 6SL3310-1PE34-6AA0	6SL3310-1PE35-8AA0 6SL3310-1PE36-6AA0 6SL3310-1PE37-4AA0	6SL3310-1PE38-4AA0 6SL3310-1PE38-8AA0 6SL3310-1PE41-0AA0
• Frame size		GX	HX	JX

¹⁾ Two dv/dt reactors are required for these dv/dt filters. The listed technical data refers to one dv/dt reactor.

SINAMICS G120P built-in and wall-mounted units

PM330 Power Modules, 160 kW to 630 kW

dv/dt filters plus VPL

Technical specifications (continued)

Line voltage 500 ... 690 V 3 AC		dv/dt filter plus VPL	
		6SL3000-2DH35-8AA0	6SL3000-2DH38-1AA0 ¹⁾
I_{th max}	A	575	810
Degree of protection		IP00	IP00
Cable length, max. between dv/dt filter and motor			
• Shielded	m (ft)	300 (984)	300 (984)
• Unshielded	m (ft)	450 (1476)	450 (1476)
Conformity		CE	CE
Certificates of suitability, according to		cURus	cURus
dv/dt reactor			
Power loss, max.			
• At 50 Hz	kW	0.862	0.828
• At 60 Hz	kW	0.902	0.867
Connections			
• To Power Module		2 × hole for M12	2 × hole for M12
• To load		2 × hole for M12	2 × hole for M12
• PE		M6 screw	M6 screw
Dimensions			
• Width	mm (in)	460 (18.1)	445 (17.5)
• Height	mm (in)	385 (15.2)	385 (15.2)
• Depth	mm (in)	312 (12.3)	312 (12.3)
Weight, approx.	kg (lb)	172 (379)	160 (353)
Voltage Peak Limiter (VPL)			
Power loss, max.			
• At 50 Hz	kW	0.063	0.106
• At 60 Hz	kW	0.059	0.1
Connections			
• To dv/dt reactor		1 x hole for M8	1 x hole for M10
• To DC link		1 x hole for M8	1 x hole for M10
• PE		M8 stud	M8 stud
Dimensions			
• Width	mm (in)	309 (12.2)	309 (12.2)
• Height	mm (in)	1312.5 (51.7)	1312.5 (51.7)
• Depth	mm (in)	400 (15.7)	400 (15.7)
Weight, approx.	kg (lb)	48 (106)	72 (159)
Suitable for PM330 Power Module		6SL3310-1PG33-7AA0 6SL3310-1PG34-0AA0 6SL3310-1PG34-5AA0	HX: 6SL3310-1PG35-2AA0 JX: 6SL3310-1PG35-8AA0 6SL3310-1PG36-5AA0 6SL3310-1PG37-2AA0
• Frame size		HX	HX/JX

¹⁾ Two dv/dt reactors are required for these dv/dt filters. The listed technical data refers to one dv/dt reactor.

SINAMICS G120P built-in and wall-mounted units

PM330 Power Modules, 160 kW to 630 kW

dv/dt filters compact plus VPL

Overview



dv/dt filters compact plus VPL (**V**oltage **P**eak **L**imiter) limit the voltage rate-of-rise dv/dt to values $< 1600 \text{ V}/\mu\text{s}$ and the typical voltage peaks to the following values according to limit value curve A to IEC 60034-25: 2007:

- $< 1150 \text{ V}$ at $U_{\text{line}} < 575 \text{ V}$
- $< 1400 \text{ V}$ at $660 \text{ V} < U_{\text{line}} < 690 \text{ V}$

Standard motors with standard insulation and without insulated bearings can be used for converter operation if a dv/dt filter compact plus VPL is used.

dv/dt filters compact plus VPL are designed for the following maximum motor cable lengths:

- Shielded cables: 100 m (328 ft) (e.g. Protodur NYCWY)
- Unshielded cables: 150 m (492 ft) (e.g. Protodur NYY)

For longer cable lengths ($> 100 \text{ m}$ (328 ft) shielded, $> 150 \text{ m}$ (492 ft) unshielded) refer to dv/dt filter plus VPL.

Note:

- The max. permissible cable length between the dv/dt filter and Power Module is 5 m (16.41 ft).
- Operation with output frequencies $< 10 \text{ Hz}$ is permissible for max. 5 min.

Design

The dv/dt filter compact plus VPL consists of two components, which are supplied together as a compact mechanical unit:

- dv/dt reactor
- Voltage limiting network, which cuts off the voltage peaks and feeds the energy back into the DC link.

Selection and ordering data

Rated power	SINAMICS G120 PM330 Power Module		dv/dt filter compact plus VPL	
400 V/ 690 V	460 V/ 575 V	Type 6SL3310-...	Frame size	Article No.
kW	hp			
380 ... 480 V 3 AC				
160	200	1PE33-0AA0	GX	6SL3000-2DE35-0EA0
200	250	1PE33-7AA0		
250	300	1PE34-6AA0		
315	400	1PE35-8AA0	HX	6SL3000-2DE38-4EA0
350	450	1PE36-6AA0		
400	500	1PE37-4AA0		
450	500	1PE38-4AA0	JX	6SL3000-2DE41-4EA0
500	600	1PE38-8AA0		
560	700	1PE41-0AA0		
500 ... 690 V 3 AC				
315	350	1PG33-7AA0	HX	6SL3000-2DG35-8EA0
355	400	1PG34-0AA0		
400	450	1PG34-5AA0		
450	450	1PG35-2AA0	HX	6SL3000-2DG38-1EA0
500	500	1PG35-8AA0	JX	6SL3000-2DG38-1EA0
560	600	1PG36-5AA0		
630	700	1PG37-2AA0		

SINAMICS G120P built-in and wall-mounted units

PM330 Power Modules, 160 kW to 630 kW

dv/dt filters compact plus VPL

Technical specifications

Line voltage 380 ... 480 V 3 AC		dv/dt filter compact plus VPL		
		6SL3000-2DE35-0EAO	6SL3000-2DE38-4EAO	6SL3000-2DE41-4EAO
I_{th max}	A	490	840	1405
Power loss, max.				
• At 50 Hz	kW	0.29	0.518	1.154
• At 60 Hz	kW	0.296	0.529	1.197
Connections				
• To Power Module		1 × hole for M10, provided for busbar connection	1 × hole for M12, provided for busbar connection	2 × hole for M12, provided for busbar connection
• To load		1 × hole for M10, provided for busbar connection	1 × hole for M12, provided for busbar connection	2 × hole for M12, provided for busbar connection
• PE		Threaded socket M6	Threaded socket M6	Threaded socket M6 (reactor and VPL)
DC link connection, DCPS, DCNS				
• Conductor cross section, max. (IEC)	mm ²	25	50	95
Cable length, max. between dv/dt filter and motor				
• Shielded	m (ft)	100 (328)	100 (328)	100 (328)
• Unshielded	m (ft)	150 (492)	150 (492)	150 (492)
Degree of protection				
		IP00	IP00	IP00
Dimensions				
• Width	mm (in)	350 (13.8)	440 (17.3)	Reactor: 430 (16.9) / VPL: 277 (10.9)
• Height	mm (in)	317 (12.5)	369 (14.5)	Reactor: 385 (15.2) / VPL: 360 (14.17)
• Depth	mm (in)	260 (10.2)	311 (12.2)	Reactor: 323 (12.7) / VPL: 291 (11.5)
Weight, approx.				
	kg (lb)	61 (134)	103 (227)	Reactor: 168.8 (372) / VPL: 19.2 (42.3)
Suitable for PM330 Power Module				
• Frame size		6SL3310-1PE33-0AA0 6SL3310-1PE33-7AA0 6SL3310-1PE34-6AA0 GX	6SL3310-1PE35-8AA0 6SL3310-1PE36-6AA0 6SL3310-1PE37-7AA0 HX	6SL3310-1PE38-4AA0 6SL3310-1PE38-8AA0 6SL3310-1PE41-0AA0 JX
Line voltage 500 ... 690 V 3 AC		dv/dt filter compact plus VPL		
		6SL3000-2DG35-8EAO	6SL3000-2DG38-1EAO	
I_{th max}	A	575	810	
Power loss, max.				
• At 50 Hz	kW	0.571	0.964	
• At 60 Hz	kW	0.586	0.998	
Connections				
• To Power Module		2 × hole for M12, provided for busbar connection	2 × hole for M12, provided for busbar connection	
• To load		2 × hole for M12, provided for busbar connection	2 × hole for M12, provided for busbar connection	
• PE		Threaded socket M6	Threaded socket M6	
DC link connection, DCPS, DCNS				
• Conductor cross section, max. (IEC)	mm ²	95	95	
Cable length, max. between dv/dt filter and motor				
• Shielded	m (ft)	100 (328)	100 (328)	
• Unshielded	m (ft)	150 (492)	150 (492)	
Degree of protection				
		IP00	IP00	
Dimensions				
• Width	mm (in)	440 (17.3)	Reactor: 430 (16.9) / VPL: 277 (10.9)	
• Height	mm (in)	369 (14.5)	Reactor: 385 (15.2) / VPL: 360 (14.2)	
• Depth	mm (in)	311 (12.2)	Reactor: 323 (12.7) / VPL: 291 (11.5)	
Weight, approx.				
	kg (lb)	100 (220)	Reactor: 171.2 (377) / VPL: 18.8 (41.4)	
Suitable for PM330 Power Module				
• Frame size		6SL3310-1PG33-7AA0 6SL3310-1PG34-0AA0 6SL3310-1PG34-5AA0 HX	HX: 6SL3310-1PG35-2AA0 JX: 6SL3310-1PG35-8AA0 6SL3310-1PG36-5AA0 6SL3310-1PG37-2AA0 HX/JX	

SINAMICS G120P built-in and wall-mounted units

Supplementary system components

Operator panels

Overview

Operator panel	Intelligent Operator Panel IOP-2 and IOP-2 Handheld	Basic Operator Panel BOP-2
Description		
Possible applications	<p>Thanks to the high-contrast color display, menu-based operation and the wizards, commissioning of the standard drives is easy. Application wizards guide the user through the commissioning of important applications such as pumps, fans, compressors and conveyor systems.</p> <ul style="list-style-type: none"> • For direct mounting on the Control Unit • Can be mounted in the control cabinet door using a door mounting kit (achievable degree of protection is IP55/UL Type 12) • IOP-2 installed as standard in the control cabinet door with SINAMICS G120P Cabinet • Available as a handheld version (with PM230 in degree of protection IP55, degree of protection IP55/UL Type 12 is no longer provided at the connection point) • The following languages are integrated in the IOP-2: <ul style="list-style-type: none"> - English, German, French, Italian, Spanish, Portuguese, Dutch, Swedish, Finnish, Russian, Czech, Polish, Turkish, Chinese (simplified) 	<p>Commissioning of standard drives is easy with the menu-prompted dialog on a 2-line display. Simultaneous display of the parameter and parameter value, as well as parameter filtering, means that basic commissioning of a drive can be performed easily and, in most cases, without a printed parameter list.</p> <ul style="list-style-type: none"> • For direct mounting on the Control Unit • Can be mounted in the control cabinet door using a door mounting kit (achievable degree of protection is IP55/UL Type 12)
Quick commissioning without expert knowledge	<ul style="list-style-type: none"> • Standard commissioning using the clone function • User-defined parameter list with a reduced number of self-selected parameters • Simple commissioning of standard applications using application-specific wizards; it is not necessary to know the parameter structure • Simple local commissioning using the handheld version • Commissioning largely without documentation 	<ul style="list-style-type: none"> • Standard commissioning using the clone function
High degree of operator friendliness and intuitive operation	<ul style="list-style-type: none"> • Direct manual operation of the drive – you can simply toggle between the automatic and manual modes • Intuitive navigation by operating with a sensor control field • Graphic color display to show status values such as pressure or flow rate in the form of scalar values, bar-type diagrams, or trend displays • Status display with freely selectable units to specify physical values • Simple cloning of specific settings of the IOP-2 user interface 	<ul style="list-style-type: none"> • Direct manual operation of the drive – you can simply toggle between the automatic and manual modes • 2-line display for showing up to 2 process values with text • Status display of predefined units
Minimization of maintenance times	<ul style="list-style-type: none"> • Diagnostics using plain text display, can be used locally on-site without documentation • Easily upgradable to new functional status via USB interface • The support function is used to determine the drive data for the Power Module, Control Unit and IOP-2 and makes this available as a two-dimensional code (data matrix/QR code) 	<ul style="list-style-type: none"> • Diagnostics with menu prompting with 7-segment display

Overview

IOP-2 Intelligent Operator Panel



IOP-2 Intelligent Operator Panel

The Intelligent Operator Panel IOP-2 is a very user-friendly and powerful operator panel for the SINAMICS G120, SINAMICS G120C, SINAMICS G120P, SINAMICS G110D, SINAMICS G120D, SINAMICS G110M and SIMATIC ET 200pro FC-2.

The IOP-2 supports both newcomers and drive experts. Thanks to the membrane keyboard with a central sensor control field, high-contrast color displays, menu-based operation and application wizards, it is easy to commission drives. A drive can be essentially commissioned without having to use a printed parameter list – as the parameters are displayed in plain text, and explanatory help texts and the parameter filtering function are provided.

Application wizards interactively guide you when commissioning important applications such as conveyor technology, pumps, fans and compressors. There is a basic commissioning wizard for general commissioning.

Up to two process values can be graphically visualized and up to four process values can be numerically visualized on the status screen/display. Process values can also be displayed in technological units.

The IOP-2 supports standard commissioning of identical drives. For this purpose, a parameter list can be copied from an inverter into the IOP-2 and downloaded into other drive units of the same type as required.

The IOP-2 can be installed in control cabinet doors using the optionally available door mounting kit (not possible in conjunction with the PM230 Power Module in degree of protection IP55).

IOP-2 Handheld



IOP-2 Handheld

A handheld version of the IOP-2 can be ordered for mobile use. In addition to the IOP-2, it includes a housing with rechargeable batteries, a charging unit, an RS232 connecting cable, and a USB cable. The charging unit is supplied with connector adapters for Europe, the US and UK. When the batteries are fully charged, the operating time is up to 10 hours.

To connect the IOP-2 Handheld to SINAMICS G110D, SINAMICS G120D, SINAMICS G110M and SIMATIC ET 200pro FC-2, the RS232 connecting cable with optical interface is required in addition.

Updating the IOP-2

The IOP-2 can be updated and expanded using the integrated USB interface.

Data to support future drive systems can be transferred from the PC to the IOP-2. Further, the USB interface allows user languages and wizards that will become available in the future to be subsequently downloaded and the firmware to be updated for the IOP-2¹⁾.

The IOP-2 is supplied with power via the USB interface during an update.

¹⁾ Information on updates for the IOP-2 is available at <https://support.industry.siemens.com/cs/document/67273266>

SINAMICS G120P built-in and wall-mounted units

Supplementary system components

IOP-2 Intelligent Operator Panel

Selection and ordering data

Description	Article No.
IOP-2 Intelligent Operator Panel English, German, French, Italian, Spanish, Portuguese, Dutch, Swedish, Finnish, Russian, Czech, Polish, Turkish, Chinese (simplified)	6SL3255-0AA00-4JA2
IOP-2 Handheld Included in the scope of delivery: <ul style="list-style-type: none"> • IOP-2 • Handheld housing • Rechargeable batteries (4 × AA) • Charging unit (international) • RS232 connecting cable ¹⁾ 3 m (9.84 ft) long • USB cable 1 m (3.28 ft) long 	6SL3255-0AA00-4HA1
Accessories Door mounting kit For mounting an operator panel in control cabinet doors with sheet steel thicknesses of 1 ... 3 mm (0.04 in ... 0.12 in) Degree of protection IP55 Included in the scope of delivery: <ul style="list-style-type: none"> • Seal • Mounting material • Connecting cable 5 m (16.4 ft) long, also supplies voltage to the IOP-2 directly via the inverter 	6SL3256-0AP00-0JA0

Integration

Mounting the IOP-2 on a Control Unit

The IOP-2 can be directly plugged onto a Control Unit.

Door mounting

Using the optionally available door mounting kit, an operator panel can be simply mounted in a control cabinet door with just a few manual operations (not possible in conjunction with the PM230 Power Module in degree of protection IP55). In the case of door mounting, the IOP-2 Operator Panel achieves degree of protection IP55/UL Type 12 enclosure.

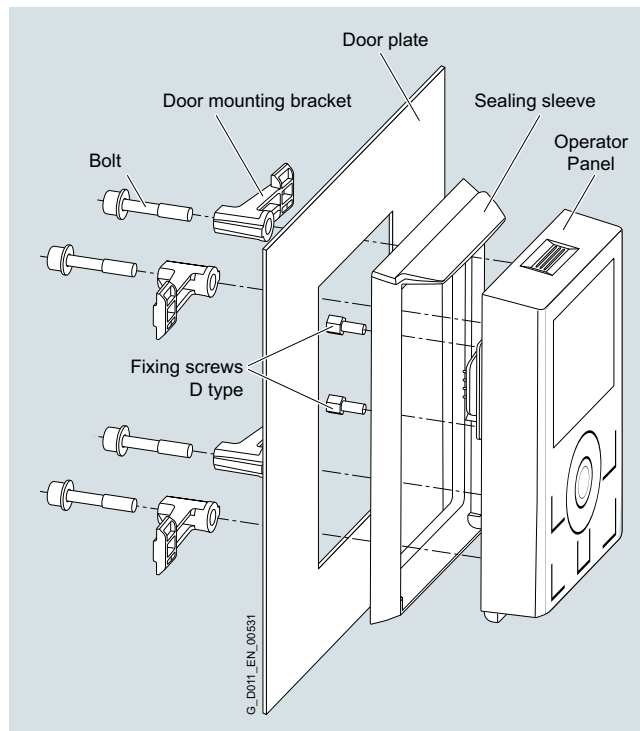

Door mounting kit with plugged-on IOP-2

Benefits

- New device design
 - Intuitive user interface – membrane keyboard with central sensor control field
 - High-contrast color display with a range of display options
 - IOP-2 device design open for future functional expansions (e.g. device functions, wizards, languages)
 - Easily upgradable to new functional status via USB interface
- Commissioning
 - Simple commissioning via wizards
 - The "Fieldbus Interface Settings" wizard is used for easy configuration of the Ethernet interface
 - Fast standard commissioning of inverters thanks to cloning function
 - Simple local commissioning on-site using the handheld version
- Operator control and monitoring
 - Simple, individual local drive control (start/stop, setpoint value specification, change in direction of rotation)
 - Application-specific scenarios such as operator concepts with additional external operating elements can be implemented easily
- Diagnostics
 - Rapid diagnostics thanks to on-site plain text display
 - Integrated plain text help function for local display and resolution of fault messages
- Support function
 - Used to determine the drive data for the Power Module, Control Unit and IOP-2 (article number, serial number, firmware version, error statuses) and makes this available as a two-dimensional code (data matrix/QR code)
 - Allows easy contact with Customer Support via a data matrix/QR code generated on the IOP-2
 - Quick access via mobile devices (e.g. smartphones, tablets) to product information, documentation, FAQs, contact persons via a two-dimensional code generated on the IOP-2 (data matrix/QR code)
 - Scanning and evaluating of the two-dimensional data matrix code using the Industry Online Support app (<https://support.industry.siemens.com/cs/ww/en/sc/2067>), see also: <https://support.industry.siemens.com/cs/ww/en/view/109748340>

SINAMICS G120P built-in and wall-mounted units

Supplementary system components

Basic Operator Panel BOP-2

Overview



Basic Operator Panel BOP-2

The Basic Operator Panel BOP-2 can be used to commission drives, monitor drives in operation and input individual parameter settings.

Commissioning of standard drives is easy with the menu-prompted dialog on a 2-line display. Simultaneous display of the parameter and parameter value, as well as parameter filtering, means that basic commissioning of a drive can be performed easily and, in most cases, without a printed parameter list.

The drives are easily controlled manually using directly assigned navigation buttons. The BOP-2 has a dedicated switchover button to switch from automatic to manual mode.

Diagnostics can easily be performed on the connected inverter by following the menus.

Up to two process values can be numerically visualized simultaneously.

BOP-2 supports standard commissioning of identical drives. For this purpose, a parameter list can be copied from a inverter into the BOP-2 and when required, downloaded into other drive units of the same type.

The operating temperature of the BOP-2 is 0 ... 50 °C (32 ... 122 °F).

Selection and ordering data

Description	Article No.
Basic Operator Panel BOP-2	6SL3255-0AA00-4CA1

Accessories

Door mounting kit

For mounting an operator panel in control cabinet doors with sheet steel thicknesses of 1 ... 3 mm (0.04 ... 0.12 in)

Degree of protection IP55

Included in the scope of delivery:

- Seal
- Mounting material
- Connecting cable (5 m/16.41 ft long, also supplies voltage to the BOP-2 directly via the Control Unit)

6SL3256-0AP00-0JA0

Benefits

- Shorten commissioning times – Easy commissioning of standard drives using basic commissioning wizards (setup)
- Minimize standstill times – Fast detection and rectification of faults (Diagnostics)
- Greater transparency in the process – The status display of the BOP-2 makes process variable monitoring easy (Monitoring)
- Direct mounting on the Control Unit (see also IOP-2)
- User-friendly user interface:
 - Easy navigation using clear menu structure and clearly assigned control keys
 - Two-line display

SINAMICS G120P built-in and wall-mounted units

Supplementary system components

Basic Operator Panel BOP-2

Integration

Mounting the BOP-2 on a CU230P-2 Control Unit

The BOP-2 can be directly plugged onto a CU230P-2 Control Unit.



PM230 Power Module and CU230P-2 Control Unit with plugged-on BOP-2

Door mounting

A BOP-2 can be installed in a control cabinet door in a few simple steps using the optionally available door mounting kit (not possible in conjunction with the PM230 Power Module in degree of protection IP55). Degree of protection IP55 is achieved for door mounting.

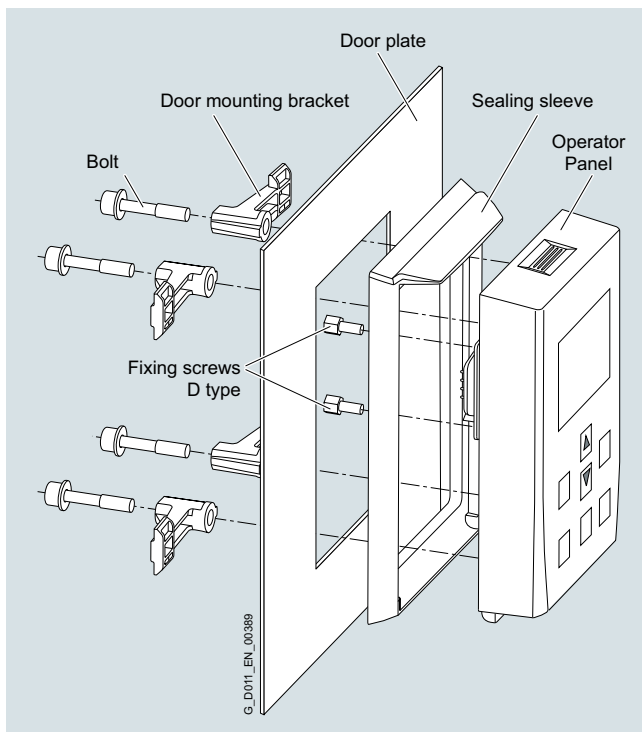

Door mounting kit with plugged-on BOP-2

SINAMICS G120P built-in and wall-mounted units

Supplementary system components

Blanking cover for PM230 Power Modules

Overview



PM230 Power Module, degree of protection IP55/UL Type 12, frame size FSC, with blanking cover

The blanking cover is mounted on the Power Module in place of an operator panel if an operator panel is not required. When the blanking cover is plugged onto the PM230 Power Module, degree of protection IP55/UL Type 12 is achieved.

Selection and ordering data

Description	Article No.
Blanking cover For PM230 Power Module degree of protection IP55/UL Type 12	6SL3256-1BA00-0AA0

Push Through mounting frame for PM230 Power Modules

Overview

It is advisable to use an optionally available mounting frame to install the Push Through unit in a control cabinet. This mounting frame includes the necessary seals and frame to ensure compliance with degree of protection IP54.

If the Power Module is installed without use of the optional mounting frame, the user is responsible for ensuring that the requisite degree of protection is provided.

Selection and ordering data

Description	Article No.
Push Through mounting frame	
• For PM230 Power Modules degree of protection IP20 Push Through variants	
- Frame size FSA	6SL3260-6AA00-0DA0
- Frame size FSB	6SL3260-6AB00-0DA0
- Frame size FSC	6SL3260-6AC00-0DA0

Adapter for PM230 Power Modules for operation with a CU240E-2 Control Unit

Overview

The adapter is required to operate a PM230 Power Module with degree of protection IP55 in frame sizes FSA to FSC in combination with a CU240E-2 Control Unit and an IOP-2/BOP-2.

Selection and ordering data

Description	Ordering
Adapter	10055500
• For PM230 Power Modules Degree of protection IP55	Ordering from and supply by KnorrTec www.knorrtec.com

SINAMICS G120P built-in and wall-mounted units

Supplementary system components

Memory cards

Overview



SINAMICS memory card (SD card)

The parameter settings for an inverter can be stored on the SINAMICS SD memory card. When service is required, e.g. after the inverter has been replaced and the data have been downloaded from the memory card the drive system is immediately ready for use again.

- Parameter settings can be written from the memory card to the inverter or saved from the inverter to the memory card.
- Up to 100 parameter sets can be stored.
- The memory card supports series commissioning without the use of an operator panel such as the IOP-2, BOP-2 or the STARTER and SINAMICS Startdrive commissioning tools.
- If firmware is stored on the memory card and a Control Unit is installed, the firmware can be upgraded/downgraded during power-up ¹⁾.

Note:

The memory card is not required for operation and does not have to remain inserted.

Selection and ordering data

Description	Article No.
SINAMICS SD card 512 MB	6SL3054-4AG00-2AA0
<i>Optional firmware memory cards for CU230P-2 Control Units</i>	
SINAMICS SD card 512 MB + firmware V4.7 SP9 (Multicard V4.7 SP9)	6SL3054-7TE00-2BA0
SINAMICS SD card 512 MB + firmware V4.7 SP10 (Multicard V4.7 SP10)	NEW 6SL3054-7TF00-2BA0

For more information about firmware V4.7 SP9:

<https://support.industry.siemens.com/cs/document/109750805>

For more information about firmware V4.7 SP10:

<https://support.industry.siemens.com/cs/document/109755811>

¹⁾ You can find more information about firmware upgrades/downgrades on the Internet at <https://support.industry.siemens.com/cs/document/67364620>

SINAMICS G120P built-in and wall-mounted units

Supplementary system components

SINAMICS G120 Smart Access

Overview



SINAMICS G120 Smart Access

It is also easy and convenient to commission and operate the SINAMICS G120, SINAMICS G120C and SINAMICS G120P frequency inverters of firmware V4.7 SP6 and higher using the SINAMICS G120 Smart Access web server module and a connected smartphone, tablet or laptop.

Selection and ordering data

Description	Article No.
SINAMICS G120 Smart Access For wireless commissioning, operation and diagnostics of the following inverters using a smartphone, tablet, or laptop <ul style="list-style-type: none"> • SINAMICS G120C • SINAMICS G120 together with the CU230P-2 and CU240E-2 Control Units (without fail-safe versions) • SINAMICS G120P together with the CU230P-2 Control Units 	NEW 6SL3255-0AA00-5AA0

Benefits

- Wireless commissioning, operation and diagnostics via mobile device or laptop thanks to the optional SINAMICS G120 Smart Access web server module
- Easy access to the inverter, even when it is installed in difficult-to-access areas
- Intuitive user interface and commissioning wizard
- Free choice of terminal devices as the web server works with all common web browsers, such as iOS, Android, Windows, Linux and Mac OS

Function

- Commissioning using commissioning wizard
- Setting and saving parameters
- Testing motor in JOG mode
- Monitoring of inverter data
- Quick diagnostics
- Saving the settings and restoring to factory settings

Integration



SINAMICS G120C with plugged-on SINAMICS G120 Smart Access



SINAMICS G120 with PM240-2 Power Module, CU240E-2 PN-F Control Unit and plugged-on SINAMICS G120 Smart Access

SINAMICS G120P built-in and wall-mounted units

Supplementary system components

SINAMICS G120 Smart Access

Integration (continued)



SINAMICS G120P with plugged-on SINAMICS G120 Smart Access

The optional SINAMICS G120 Smart Access is simply plugged onto the inverter and is available for the following inverters of firmware V4.7 SP6 and higher.

- SINAMICS G120C
- SINAMICS G120 together with the CU230P-2 and CU240E-2 Control Units (without fail-safe versions)
- SINAMICS G120P together with the CU230P-2 Control Units
Please refer to [Catalog D 35](#) for more information.

Technical specifications

SINAMICS G120 Smart Access	
	6SL3255-0AA00-5AA0
Operating system	iOS, Android, Windows, Linux, Mac OS
Languages	Support for six languages: English, French, German, Italian, Spanish, Chinese
Ambient temperature	
• During transport and storage	-40 ... +70 °C (-40 ... +158 °F)
• During operation	0 ... 50 °C (32 ... 122 °F) with the Smart Access module plugged onto the inverter
Humidity	<95 %, non-condensing
Degree of protection	Depending on inverter degree of protection, max. IP55/UL Type 12 enclosure
Dimensions	
• Width	70 mm (2.76 in)
• Height	108.9 mm (4.29 in)
• Depth	17.3 mm (0.68 in)
Weight, approx.	0.08 kg (2.82 oz)
Compliance with standards	CE, FCC, SRRC, WPC, ANATEL, BTK

4

PC inverter connection kit 2

Overview



PC inverter connection kit 2

For controlling and commissioning an inverter directly from a PC, if the STARTER commissioning tool ¹⁾ has been installed on the PC. With this, the inverter can be

- parameterized (commissioning, optimization)
- monitored (diagnostics)
- controlled (master control via the STARTER commissioning tool ¹⁾ for test purposes)

A USB cable (3 m/9.84 ft) is included in the scope of delivery.

The PC inverter connection kit 2 is suitable for the following SINAMICS G120 Control Units:

- CU230P-2 HVAC
- CU230P-2 DP
- CU230P-2 PN
- CU240E-2
- CU240E-2 DP
- CU240E-2 PN
- CU240E-2 F
- CU240E-2 DP-F
- CU240E-2 PN-F
- CU250S-2

Selection and ordering data

Description	Article No.
PC inverter connection kit 2 for CU230P-2, CU240E-2 and CU250S-2 Control Units including USB cable (length 3 m/9.84 ft)	6SL3255-0AA00-2CA0

¹⁾ The STARTER commissioning tool is also available on the Internet at <https://support.industry.siemens.com/cs/document/26233208>

SINAMICS G120P built-in and wall-mounted units

Supplementary system components

Shield connection kits for CU230P-2 Control Units

Overview

The shield connection kit offers for all signal and communication cables

- Optimum shield connection
- Strain relief

A shield connection kit contains the following:

- A matching shield bonding plate
- All of the necessary connecting and retaining elements for mounting

The shield connection kits are suitable for the following SINAMICS G120 Control Units in combination with PM230/PM240P-2 Power Modules:

- CU230P-2 HVAC
- CU230P-2 DP
- CU230P-2 PN

Selection and ordering data

Description	Article No.
Shield connection kit 1 for CU230P-2 HVAC/DP Control Units	6SL3264-1EA00-0FA0
Shield connection kit 3 For CU230P-2 PN Control Units	6SL3264-1EA00-0HB0

Shield connection kits and plates for PM230/PM240P-2 Power Modules

Overview

PM230 Power Modules, frame sizes FSA to FSC, and PM240P-2 Power Modules are supplied with a shield plate for motor and signal cables.

Shield connection kits are available for standard PM230 Power Modules, frame sizes FSD to FSF, in degree of protection IP20.

Shield connection kits are available as spare parts for PM240P-2 Power Modules.

Selection and ordering data

Description	Article No.
Shield plate for PM230 Power Modules Degree of protection IP20	Supplied with the Power Modules, available as a spare part
• Frame sizes FSA to FSC	
Shield plate for PM240P-2 Power Modules	Supplied with the Power Modules, shield connection kits are available as spare parts
• Frame sizes FSD to FSF	
Shield connection kit for PM230 Power Module degree of protection IP20 Standard variants	6SL3262-1AD00-0DA0 6SL3262-1AF00-0DA0
• Frame sizes FSD and FSE • Frame size FSF	

4

Installation kit for line-side cable connection, left, for PM330

Overview

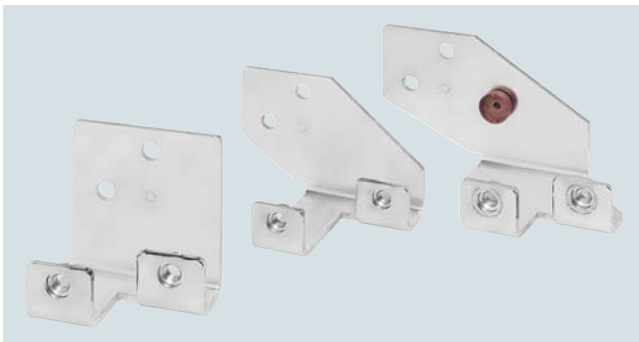

Installation kit for line-side cable connection, left, for PM330 frame size HX

This installation kit allows supply cables to be connected on the left-hand side of the frame size GX and HX PM330 Power Modules. The Power Module can then be installed higher in the control cabinet, allowing more efficient use of the available cabinet space. In many cases, use of this installation kit also helps in the implementation of effective cabinet cooling.

Information about installation can be found in the [SINAMICS G120P Hardware Installation Manual for the PM330 Power Module](#).

Selection and ordering data

Rated power kW	SINAMICS G120 PM330 Power Module hp	Type 6SL3310-...	Frame size	Installation kit for line-side cable connection, left Article No.
380 ... 480 V 3 AC				
160	200	1PE33-0AA0	GX	6SL3366-1LG00-0PA0
200	250	1PE33-7AA0		
250	300	1PE34-6AA0		
315	400	1PE35-8AA0	HX	6SL3366-1LH00-0PA0
355	450	1PE36-6AA0		
400	500	1PE37-4AA0		
500 ... 690 V 3 AC				
315	350	1PG33-7AA0	HX	6SL3366-1LH00-0PA0
355	400	1PG34-0AA0		
400	450	1PG34-5AA0		
450	450	1PG35-2AA0		

SINAMICS G120P built-in and wall-mounted units

Spare parts

Spare parts kit for Control Units

Overview

The spare part kit contains small parts for all variants of the following SINAMICS G120 Control Units:

- CU230P-2
- CU240E-2
- CU240E-2 F
- CU250S-2

Included in the scope of delivery:

- Label set for all variants of the CU230P-2, CU240E-2, CU240E-2 F and CU250S-2 Control Units
- 2x replacement doors (top/bottom)
- 2x labeling strips for use on the doors
- 1x 4, 5, 6, 7, 8, 9, 10 and 11-pole terminal blocks
- 1x protective element for memory card slot
- 1 × screw for SUB-D interface

Selection and ordering data

Description	Article No.
Spare part kit for Control Units CU230P-2, CU240E-2, CU240E-2 F and CU250S-2	6SL3200-0SK01-0AA0

Shield connection kits for PM240P-2 Power Modules

Overview

A set of shield plates is included in the scope of delivery of PM240P-2 Power Modules for motor and signal cables corresponding to the frame size. Shield connection kits can be ordered as spare parts.

Selection and ordering data

Description	Article No.
Shield connection kit for PM240P-2 Power Modules	
• Frame size FSD	6SL3262-1AD01-0DA0
• Frame size FSE	6SL3262-1AE01-0DA0
• Frame size FSF	6SL3262-1AF01-0DA0

Shield plates for PM230 Power Modules

Overview

PM230 Power Modules, frame sizes FSA to FSC, in degree of protection IP20, are supplied with a shield plate for motor and signal cables. This shield plate is also available as a spare part.

Selection and ordering data

Description	Article No.
Shield plate For PM230 Power Modules degree of protection IP20 Standard variants (and SINAMICS G120C)	
• Frame size FSA	6SL3266-1EA00-0KA0
• Frame size FSB	6SL3266-1EB00-0KA0
• Frame size FSC	6SL3266-1EC00-0KA0
Shield plate For PM230 Power Modules degree of protection IP20 Push Through variants	
• Frame size FSA	6SL3266-1EA00-0DA0
• Frame size FSB	6SL3266-1EB00-0DA0
• Frame size FSC	6SL3266-1EC00-0DA0

SINAMICS G120P built-in and wall-mounted units

Spare parts

Mounting sets for PM230 and PM240P-2 Power Modules

Overview

The following parts are supplied from the factory for each PM230 Power Module in degree of protection IP55/UL Type 12 or IP20:

Frame sizes FSA to FSC	Frame sizes FSD to FSF (only for Power Modules with degree of protection IP55)
<ul style="list-style-type: none"> 1 SUB-D connector with mounting material for connecting the CU230P-2 HVAC/DP/PN Control Units to the operator panel (e.g. IOP-2) 1 motor connector and 1 power supply connector 2 serrated strips including mounting material for connecting the shield 3 sleeves for inserting in the cutouts for the signal cables of the cable bonding plate Ferrite cores (only necessary for devices with integrated line filter class B) 2-page Quick Start Guide with mounting instructions 	<ul style="list-style-type: none"> 1 adapter cable for connecting the CU230P-2 HVAC/DP/PN Control Units to the operator panel (e.g. IOP-2) 4 clips to connect the shields of signal cables 6 serrated strips including mounting material for the motor and supply cables 4 sleeves (pre-installed in the cutouts for the signal cables of the cable bonding plate) 1 cable bonding plate without cutouts for customers to configure their own connection system 1 cabinet key 2-page Quick Start Guide with mounting instructions

Mounting sets can be ordered for all frame sizes and degrees of protection for PM230 and PM240P-2 Power Modules. Each one contains the following parts:

PM230 Power Modules, frame sizes FSA to FSC PM240P-2 Power Module	PM230 Power Modules, frame sizes FSD to FSF (only for Power Modules with degree of protection IP55)
<ul style="list-style-type: none"> 1 SUB-D connector with mounting material 1 motor connector and 1 power supply connector 2 serrated strips including mounting material for connecting the shield 3 sleeves for inserting in the cutouts for the signal cables of the cable bonding plate Ferrite cores (only necessary for devices with integrated line filter class B) Screws for fixing the cable bonding plate and the cover 	<ul style="list-style-type: none"> 1 adapter cable including mounting material 6 serrated strips including mounting material for the motor and supply cables 1 cabinet key

Selection and ordering data

Description	Article No.
Mounting set For PM230 Power Modules Degree of protection IP55/UL Type 12 or IP20	
• Frame size FSA	6SL3200-0SK02-0AA0
• Frame size FSB	6SL3200-0SK03-0AA0
• Frame size FSC	6SL3200-0SK04-0AA0
Mounting set for PM230 Power Modules Degree of protection IP55	
• Frame size FSD	6SL3200-0SK05-0AA0
• Frame size FSE	6SL3200-0SK06-0AA0
• Frame size FSF	6SL3200-0SK07-0AA0
Mounting set for PM240P-2 Power Modules	
• Frame sizes FSD, FSE, FSF	6SL3200-0SK08-0AA0

4

Terminal cover kits for Power Modules, frame sizes FSD to FSF

Overview

The terminal cover kit includes a replacement cover for the connecting terminals.

Terminal cover kits are available for the following SINAMICS G120P Power Modules, frame sizes FSD to FSF:

- PM230 degree of protection IP20 standard variant
- PM240P-2

Selection and ordering data

Description	Article No.
Terminal cover kits for PM230 Power Modules, degree of protection IP20, standard variant	
• For frame sizes FSD and FSE	6SL3200-0SM11-0AA0
• For frame size FSF	6SL3200-0SM12-0AA0
Terminal cover kits for PM240P-2 Power Modules	
• For frame size FSD	6SL3200-0SM13-0AA0
• For frame size FSE	6SL3200-0SM14-0AA0
• For frame size FSF	6SL3200-0SM15-0AA0

SINAMICS G120P built-in and wall-mounted units

Spare parts

Fan units for PM230 Power Modules

Overview

The Power Module fans are designed for extra long service life. For special requirements, replacement fans are available that can be exchanged quickly and easily. When selecting the external fan units, please note the hardware version printed on the device rating plate. The following pictures show the mounting location of internal and external fan units as an example:



PM230 Power Module, degree of protection IP55/UL Type 12, frame size FSC, with external fan unit in heat sink



PM230 Power Module, degree of protection IP55/UL Type 12, frame size FSC, with internal fan unit above CU230P-2 Control Unit

Selection and ordering data

Rated power		PM230 Power Module degree of protection IP55/UL Type 12 ¹⁾		External fan unit	Internal fan unit
400 V kW	460 V hp	Type 6SL3223-...	Frame size	Article No	Article No.
380 ... 480 V 3 AC					
0.37	0.5	ODE13-7 . G1	FSA	6SL3200-0SF21-0AA1	6SL3200-0SF31-0AA0
0.55	0.75	ODE15-5 . G1			
0.75	1	ODE17-5 . G1			
1.1	1.5	ODE21-1 . G1			
1.5	2	ODE21-5 . G1			
2.2	3	ODE22-2 . G1			
3	4	ODE23-0 . G1			
4	5	ODE24-0 . G1	FSB	6SL3200-0SF22-0AA1	
5.5	7.5	ODE25-5 . G1			
7.5	10	ODE27-5 . G1			
11	15	ODE31-1 . G1	FSC	6SL3200-0SF23-0AA1	
15	20	ODE31-5 . G1			
18.5	25	ODE31-8AG1		6SL3200-0SF23-0AA0	6SL3200-0SF32-0AA0
18.5	25	ODE31-8BA0	FSD	6SL3200-0SF24-0AA0	
22	30	ODE32-2 . A0			
30	40	ODE33-0 . A0			
37	50	ODE33-7 . A0	FSE		
45	60	ODE34-5 . A0			
55	75	ODE35-5 . A0	FSF	6SL3200-0SF26-0AA0	
75	100	ODE37-5 . A0			
90	125	ODE38-8 . A0			

¹⁾ For degree of protection IP55/UL Type 12, the UL approval only applies to frame sizes FSA to FSC.

SINAMICS G120P built-in and wall-mounted units

Spare parts

Fan units for PM230 Power Modules

Selection and ordering data (continued)

Rated power		PM230 Power Module degree of protection IP20 Standard variant		External fan unit
400 V kW	460 V hp	Type 6SL3210-...	Frame size	Article No.
380 ... 480 V 3 AC				
0.37	0.5	1NE11-3 . G1	FSA	–
0.55	0.75	1NE11-7 . G1		
0.75	1	1NE12-2 . G1	FSA	6SL3200-0SF12-0AA0
1.1	1.5	1NE13-1 . G1		
1.5	2	1NE14-1 . G1		
2.2	3	1NE15-8 . G1		
3	4	1NE17-7 . G1		
4	5	1NE21-0 . G1	FSB	6SL3200-0SF13-0AA0
5.5	7.5	1NE21-3 . G1		
7.5	10	1NE21-8 . G1		
11	15	1NE22-6 . G1	FSC	6SL3200-0SF14-0AA0
15	20	1NE23-2 . G1		
18.5	25	1NE23-8 . G1		
22	30	1NE24-5 . L0	FSD	6SL3200-0SF05-0AA0
30	40	1NE26-0 . L0		
37	50	1NE27-5 . L0	FSE	
45	60	1NE28-8 . L0		
55	75	1NE31-1 . L0	FSF	6SL3200-0SF08-0AA0
75	100	1NE31-5 . L0		
Rated power		PM230 Power Module degree of protection IP20 Push Through variant		External fan unit
400 V kW	460 V hp	Type 6SL3211-...	Frame size	Article No.
380 ... 480 V 3 AC				
3	4	1NE17-7 . G1	FSA	6SL3200-0SF21-0AA0
7.5	10	1NE21-8 . G1	FSB	6SL3200-0SF22-0AA0
18.5	25	1NE23-8 . G1	FSC	6SL3200-0SF23-0AA0

SINAMICS G120P built-in and wall-mounted units

Spare parts

Replacement fans for PM240P-2 and PM330 Power Modules

Overview

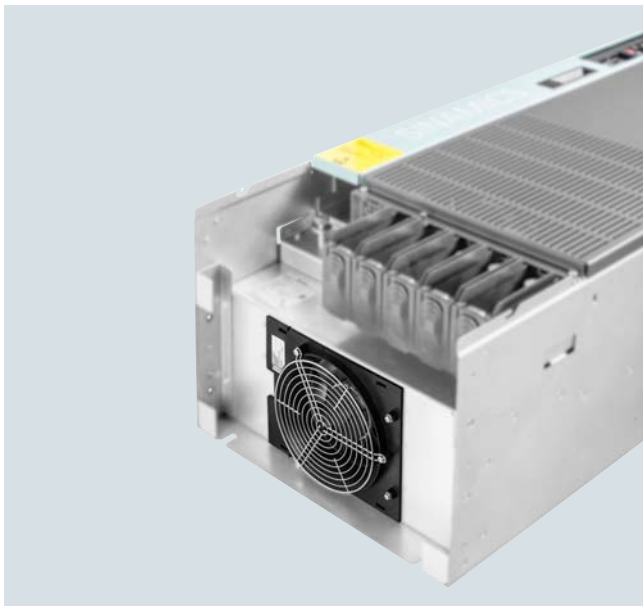

The fans for PM240P-2 and PM330 Power Modules are available to order as replacement fans.

PM330 Power Module frame size GX with base-mounted fan

Selection and ordering data

Rated power		PM240P-2 Power Modules		Replacement fan
400 V/690 V	460 V/575 V	Type 6SL3210-...	Frame size and number of fans	Article No.
kW	hp			
380 ... 480 V 3 AC				
22	25	1RE24-5 . LO	FSD, 1 fan	6SL3200-0SF15-0AA0
30	30	1RE26-0 . LO		
37	40	1RE27-5 . LO		
45	50	1RE28-8 . LO	FSE, 1 fan	6SL3200-0SF16-0AA0
55	60	1RE31-1 . LO		
75	75	1RE31-5 . LO	FSF, 1 fan	6SL3200-0SF17-0AA0
90	100	1RE31-8 . LO		
110	125	1RE32-1 . LO		
132	150	1RE32-5 . LO		
500 ... 690 V 3 AC				
11	10	1RH21-4 . LO	FSD, 1 fan	6SL3200-0SF15-0AA0
15	15	1RH22-0 . LO		
18.5	20	1RH22-3 . LO		
22	25	1RH22-7 . LO		6SL3200-0SF16-0AA0
30	30	1RH23-5 . LO		
37	40	1RH24-2 . LO		6SL3200-0SF17-0AA0
45	50	1RH25-2 . LO	FSE, 1 fan	
55	60	1RH26-2 . LO		
75	75	1RH28-0 . LO	FSF, 1 fan	6SL3200-0SF17-0AA0
90	100	1RH31-0 . LO		
110	125	1RH31-2 . LO		
132	150	1RH31-4 . LO		

SINAMICS G120P built-in and wall-mounted units

Spare parts

Replacement fans for PM240P-2 and PM330 Power Modules

Selection and ordering data (continued)

Rated power		PM330 Power Modules		Replacement fan
400 V/690 V	460 V/575 V	Type 6SL3310-...	Frame size and number of fans	Article No.
kW	hp			
380 ... 480 V 3 AC				
160	200	1PE33-0AA0	GX, 1 fan	6SL3300-0SF01-0AA0
200	250	1PE33-7AA0		
250	300	1PE34-6AA0		
315	400	1PE35-8AA0	HX, 2 fans	6SL3300-0SF01-0AA0
355	450	1PE36-6AA0		
400	500	1PE37-4AA0		
450	500	1PE38-4AA0	JX, 2 fans	6SL3300-0SF01-0AA0
500	600	1PE38-8AA0		
560	700	1PE41-0AA0		
500 ... 690 V 3 AC				
315	350	1PG33-7AA0	HX, 2 fans	6SL3300-0SF01-0AA0
355	400	1PG34-0AA0		
400	450	1PG34-5AA0		
450	450	1PG35-2AA0		6SL3300-0SF01-0AA0
500	500	1PG35-8AA0	JX, 2 fans	
560	600	1PG36-5AA0		
630	700	1PG37-2AA0		

SINAMICS G120P built-in and wall-mounted units

Notes

4

SINAMICS G120P Cabinet, converter cabinet units, degree of protection IP20 to IP54



Use in water/wastewater
and industrial applications

5/2 **SINAMICS G120P Cabinet, 75 kW to 630 kW**

5/2 Overview
5/2 Benefits
5/3 Application
5/3 Design
5/5 Function
5/7 Configuration
5/9 Selection and ordering data
5/10 Options
5/21 Technical specifications
5/28 Characteristic curves

5/31 **Recommended line-side power components**

5/31 Selection and ordering data

SINAMICS G120P Cabinet, converter cabinet units

SINAMICS G120P Cabinet, 75 kW to 630 kW

SINAMICS G120P Cabinet

Overview



SINAMICS G120P Cabinet, converter cabinet units, versions A and C

With its SINAMICS G120P Cabinet converter cabinet units, Siemens is offering a cost-effective drive system on which all line-side and motor-side components as well as the Power Module are integrated into a ready-to-use standardized cabinet system.

A wide range of catalog options are available for the implementation of customer-specific configurations, which are complemented and type tested in the overall system. Special requests can be implemented on request on account of the flexible production process.

The SINAMICS G120P Cabinet is especially suitable for pumps, fans, and compressor applications on account of the special functions included in the standard version, such as pump cascading, multi-zone control, emergency mode, etc.

With its high-performance, sensorless vector control, the very ruggedly designed converter covers a wide range of applications – even in harsh industrial environments. Simple, clear engineering supports assist the correct selection of components, and thus form the basis for safe, long-term operation.

Commissioning with the Intelligent Operator Panel (IOP-2) integrated in the control cabinet door can be performed quickly and easily. A commissioning wizard guides the user conveniently through all the essential commissioning parameters.

There are two versions of the converter cabinet units:

- **Version A (75 kW to 630 kW)**
enables all optionally available line connection components, such as the main switch, main contactor, line fuses, line filter, motor-side components and additional monitoring devices to be installed
- **Version C (160 kW to 400 kW at 380 V to 480 V 3 AC and 315 kW to 450 kW at 500 V to 690 V 3 AC)**
space-saving design with line reactor and optional main switch. This particularly slimline design can be used, for example, when line connection components are accommodated in a central low-voltage distribution panel (MCC) in the customer's plant or system.

SINAMICS G120P Cabinet converter cabinet units are available for the following voltages and outputs:

Line voltage	Power range
380 ... 480 V 3 AC	75 ... 560 kW
500 ... 690 V 3 AC	315 ... 630 kW

The units have degree of protection IP20 as standard. They are optionally available with degrees of protection IP21, IP23, IP43 and IP54.

Benefits

- **Simple, safe configuration:** The SINAMICS G120P Cabinet can be easily and safely configured with the aid of operating characteristics and the SIZER dimensioning tool.
- **Simple selection:** Multiple options facilitate an individual customer configuration (special applications can be realized on request)
- **Simple, local connection:** The cabinets are tested, supplied ready-to-use, and can be easily connected – without disassembly of components.
- **Simple, fast commissioning:** Commissioning via the Intelligent Operator Panel (IOP-2) integrated in the cabinet door can be performed quickly and easily. The user-friendly guidance enables a reliably configured drive to be realized in a few steps.
- A range of field bus interfaces provide **simple, diverse networking facilities.** The SINAMICS G120P Cabinet can be especially easily integrated into operating, machine and process sequences via the Totally Integrated Automation (TIA) portal and other tools.
- **Safe operation** through comprehensive monitoring and protection functions, and a maintenance-free design. As well as complete monitoring of the electrical parameters and safe shutdown if the set limiting values are exceeded, thermal parameters are continuously monitored.
- **Resource and energy saving:** The SINAMICS G120P Cabinet has very high efficiency verified according to EN 50598. Energy-saving functions and the automatic pulse frequency adjustment offer the best possible energy efficiency, thus saving on operating costs with every hour of use.
- **Long lived** through the rugged design, for use in harsh ambient conditions and suitable system components. The protective coating of modules and metal surfaces, as well as the hardest operational tests enable long-term, safe operation, even in harsh industrial environments.
- **Integrated Drive System (IDS):** The integration of the SINAMICS G120P Cabinet into the IDS concept offers an optimal interaction of individual components in the drive train with the highest energy efficiency and the highest possible reliability.
- **EPLAN macros:** EPLAN macros are available not only for built-in units but also for the customer-specific, configurable SINAMICS G120P Cabinet system. This enables the entire cabinet system to be very easily integrated into a CAE system by import.

SINAMICS G120P Cabinet, converter cabinet units

SINAMICS G120P Cabinet, 75 kW to 630 kW

SINAMICS G120P Cabinet

Application

Variable-speed drives are ideal for all applications that involve moving, conveying, pumping, or compressing liquids or gases.

This means the following applications in particular:

- Pumps
- Fans
- Compressors

Design

SINAMICS G120P Cabinet converter cabinet units are characterized by their modular and service-friendly design.

A wide range of options is available depending on the cabinet version, which permits optimum adaptation of the drive system to the respective requirements (see section Options).

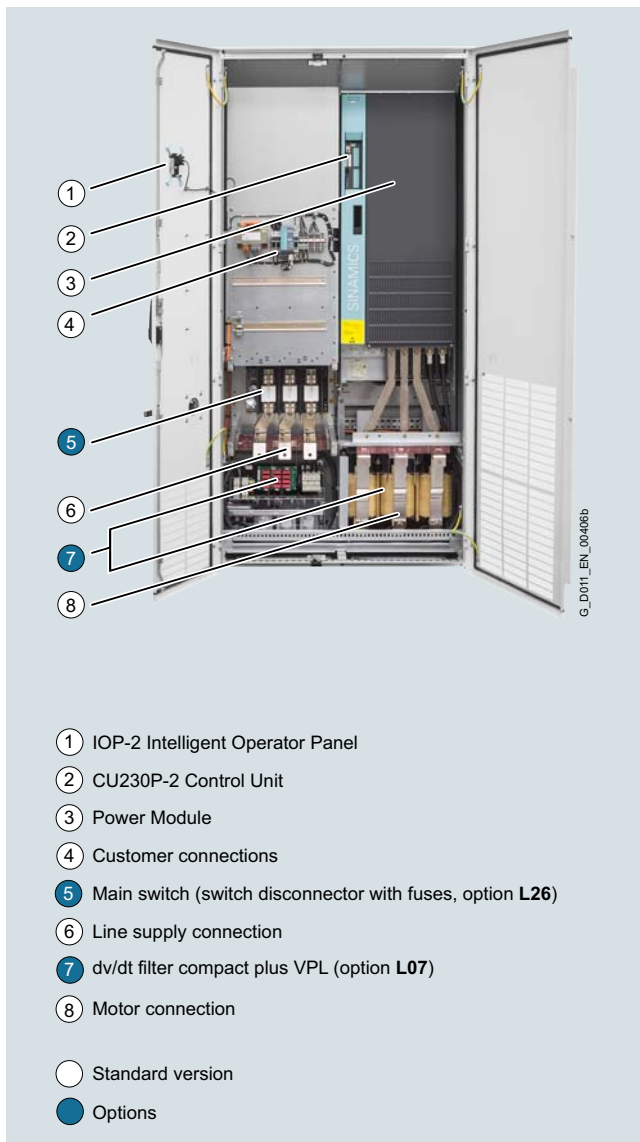

Example of design of a SINAMICS G120P Cabinet, converter cabinet unit, version A with PM330 Power Module and CU230P-2 Control Unit

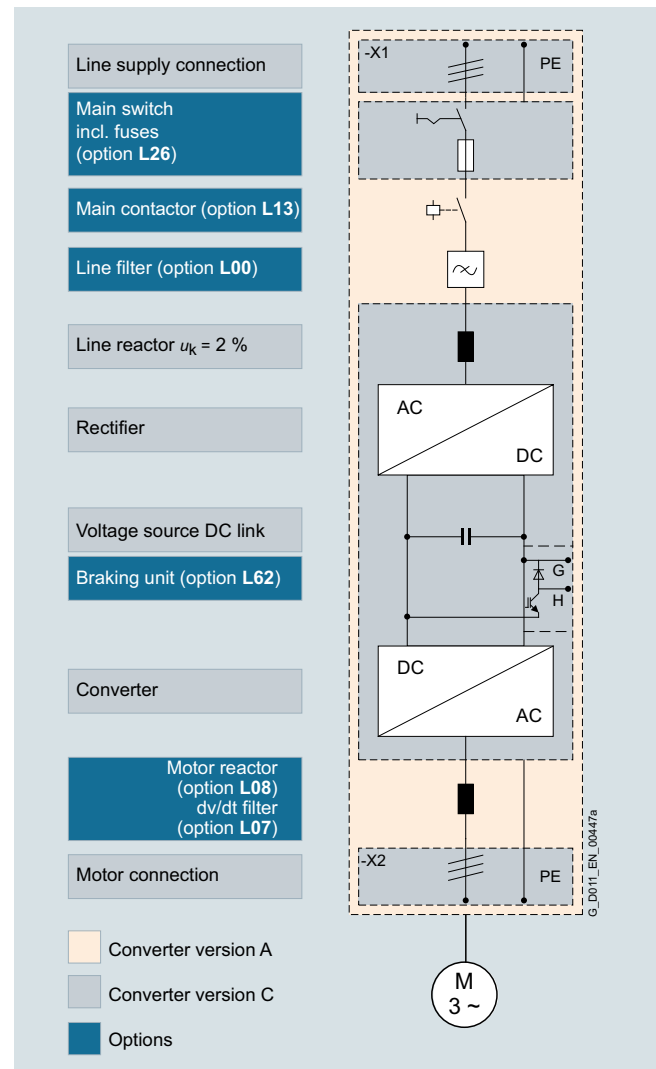

Basic design of a SINAMICS G120P Cabinet, converter cabinet unit with PM330 Power Module and several significant options

SINAMICS G120P Cabinet, converter cabinet units

SINAMICS G120P Cabinet, 75 kW to 630 kW

SINAMICS G120P Cabinet

Design (continued)

Coated modules

The following converter components are equipped as standard with coated modules:

- Power Modules
- Control Units
- Intelligent Operator Panel IOP-2

The coating on the modules protects the sensitive SMD components against corrosive gases, chemically active dust and moisture.

Nickel-plated busbars

All of the busbars used in the converter cabinet are nickel-plated in order to achieve the best possible immunity to environmental effects. Further, the bare copper connections do not have to be cleaned for customer connections.

Note:

For some options, for technical reasons, parts of the copper busbars cannot be nickel-plated.

EMC shielding busbars and PE busbars

The Cabinet Modules are delivered with a EMC shielding busbar and a PE busbar as standard. The EMC shielding busbar is used to connect shielded power cables for line and motor supply cables. The PE busbar is used to connect and secure PE cables.

Crane transport aids

The converter cabinet units are supplied with a crane transport aid mounted on the top. In the case of single cabinets up to a width of 1200 mm (47.2 in), transport eyebolts are provided to transport the unit by crane. Transport rails are used with cabinet widths >1200 mm (47.2 in) or for several cabinets (e.g. option **L01**). Rope spreaders should be used for low crane hook heights.

Degrees of protection of cabinet units

The EN 60529 standard covers the protection of electrical equipment by means of housings, covers or equivalent, and includes:

- Protection of persons against accidental contact with live or moving parts within the housing and protection of the equipment against the ingress of solid foreign matter (touch protection and protection against ingress of solid foreign bodies)
- Protection of the equipment against the ingress of water (water protection)
- Abbreviations for the internationally agreed degrees of protection

The degrees of protection are specified by abbreviations comprising the code letters IP and two digits.

Degrees of protection of the converter cabinet unit	First digit (touch protection and protection against ingress of foreign solid matter)	Second digit (protection of the equipment against the ingress of water)
IP20 (standard)	Protected against solid foreign bodies with a diameter ≥ 12.5 mm.	No water protection
IP21 (option M21)	Protected against solid foreign bodies with a diameter ≥ 12.5 mm.	Protected against drip water Vertically falling drip water shall not have a harmful effect.
IP23 (option M23)	Protected against solid foreign bodies with a diameter ≥ 12.5 mm.	Protected against spray water Water sprayed on both sides of the vertical at an angle of up to 60° shall not have a harmful effect.
IP43 (option M43)	Protected against solid foreign bodies with a diameter ≥ 1 mm.	Protected against spray water Water sprayed on both sides of the vertical at an angle of up to 60° shall not have a harmful effect.
IP54 (option M54)	Dust protected. Ingress of dust is not totally prevented, but dust must not be allowed to enter in such quantities that the functioning or safety of the equipment is impaired.	Protected against splash water Water splashing onto the enclosure from any direction shall not have a harmful effect.

Function



Intelligent Operator Panel IOP-2

The IOP-2 (Intelligent Operator Panel) is mounted in the door of the cabinet units. It is used to operate and commission the drive system. The IOP-2 is an extremely user-friendly, powerful operator panel.

The IOP-2 supports both newcomers and drive experts. Thanks to the membrane keyboard with central sensor control field, high-contrast color display, menu-based operation and application wizards, it is easy to commission drives. A drive can be essentially commissioned without having to use a printed parameter list – as the parameters are displayed in plain text, and explanatory help texts and the parameter filtering function are provided.

Application wizards interactively guide you when commissioning important applications such as pumps and fans. There is a basic commissioning wizard for general commissioning.

The converter can be diagnosed in a user-friendly fashion using the plain text display of faults and alarms. Help texts can be obtained by pressing the INFO button. Up to two process values can be graphically visualized and up to four process values can be numerically visualized on the status screen/display. Process values can also be displayed in technological units.

The IOP-2 supports standard commissioning of identical drives. For this purpose, a parameter list can be copied from a converter into the IOP-2 and downloaded into other drive units of the same type as required. This functionality is available only if a memory card is installed in the Control Unit.

The following languages are integrated in the IOP-2:
English, German, French, Italian, Spanish, Portuguese, Dutch, Swedish, Finnish, Russian, Czech, Polish, Turkish, Chinese (simplified)

The operating temperature of the IOP-2 is 0 to 50 °C (32 to 122 °F).

Communication with higher-level control and customer terminal block

Depending on the selected CU230P-2 Control Unit, the following interfaces for communication with the higher-level control system are provided:

- PROFINET, EtherNet/IP (option **K96**)
- PROFIBUS (option **K97**)
- USS/Modbus RTU/BACnet MS/TP, FLN P1 (option **K98**)

The Control Unit can be connected to the higher-level control via its digital inputs and outputs.

Open-loop and closed-loop control functions

The converter control contains a high-quality, sensorless vector control with speed and current controls as well as motor and converter protection.

SINAMICS G120P Cabinet, converter cabinet units

SINAMICS G120P Cabinet, 75 kW to 630 kW

SINAMICS G120P Cabinet

Function (continued)

Software and protective functions

The software functions available as standard are described below:

Software and protective functions	Description
Setpoint input	The setpoint can be input both internally and externally. It is applied internally as a fixed setpoint, motorized potentiometer setpoint or jog setpoint and externally via the communications interface or an analog input on the customer terminal block. The internal fixed setpoint and the motorized potentiometer setpoint can be switched over or adjusted using control commands from any interface.
Motor identification	The automatic motor identification function makes commissioning faster and easier and optimizes closed-loop control of the drive.
Ramp-function generator	An advanced ramp-function generator with separately adjustable ramping times, together with adjustable rounding times in the lower and upper speed ranges, allows the drive to be smoothly accelerated and braked. As a consequence, this avoids the drive train from being overloaded and reduces the stress on mechanical components. The down ramps can be parameterized separately for quick stop.
V_{dc max} controller	The V _{dc max} controller automatically prevents overvoltages in the DC link if the set down ramp is too short, for example. This may also extend the set ramp-down time.
Kinetic buffering (KIP)	In the event of supply voltage dips, the kinetic energy of the rotating drive is used to buffer the DC link so as to prevent fault trips. The converter remains operational as long as the drive can provide regenerative energy as a result of its motion and the DC link voltage does not drop below the trip threshold. When the line supply recovers within this time, the drive is again accelerated up to its setpoint speed.
Automatic restart¹⁾	The automatic restart switches the drive on again when the power is restored after a power failure, and ramps up to the current speed setpoint.
Flying restart¹⁾	The "Flying restart" function allows the converter to be switched to a motor that is still turning.
Technology controller	The technology controllers (in the form of PID controllers) can be used to implement simple closed-loop control functions. A PID controller controls the motor speed as a process controller for temperature, pressure, air quality or fill levels. Three further PID controllers are freely programmable. The P, I, and D component can be disabled.
Free function blocks	Using the freely programmable function blocks, it is easy to implement logic and arithmetic functions for controlling the SINAMICS G120P Cabinet unit. The blocks can be programmed by means of an operator panel or the STARTER commissioning tool.
P_t detection for motor protection	A motor model stored in the converter software calculates the motor temperature based on the current speed and load. More exact sensing of the temperature, which also takes into account the influence of the ambient temperature, is possible by means of direct temperature sensing using KTY sensors in the motor winding.
Motor temperature evaluation	Motor protection by evaluating a temperature sensor of type KTY, PTC, Pt1000 or bimetal NC contact. When a KTY sensor is connected, the limit values can be set for warning or shutdown. When a PTC thermistor is connected, the system reaction to triggering of the thermistor (alarm or shutdown) can be defined.
Motor blocking protection	A blocked motor is detected and protected against thermal overloading by a fault trip.
Multi-zone control	Closed-loop control of a zone with up to 3 sensors for pressure or temperature, or closed-loop control of two independent zones each with one sensor.
Essential service mode	Special converter operating mode that enhances the availability of the drive system in the event of a fire.
Bypass²⁾	When the setpoint is reached or a fault occurs, there is a changeover to mains operation.
Cascade connection²⁾	Load-dependent connection and disconnection of a maximum of three additional motors by the converter in order to provide a largely constant output power.
Hibernation mode	Startup or shutdown of the drive when the relevant value drops below an external setpoint or the internal PID controller setpoint
Power unit protection	Description
Ground fault monitoring at output end	A ground fault at the output end is detected by a summation current monitor and results in shutdown in grounded systems.
Electronic short-circuit protection at the output end	A short-circuit at the output end (e.g. at the converter output terminals, in the motor cable or in the motor terminal box) is detected and the converter shuts down with "fault".
Thermal overload protection	An alarm is issued first when the overtemperature threshold responds. If the temperature rises further, the unit independently adjusts the pulse frequency or output current so that a reduction in the thermal load is achieved. Once the cause of the fault has been eliminated (e.g. cooling has been improved), the original operating values are automatically resumed.

¹⁾ Factory setting: not activated (can be parameterized).

²⁾ This function requires an additional external circuit.

SINAMICS G120P Cabinet, converter cabinet units

SINAMICS G120P Cabinet, 75 kW to 630 kW

SINAMICS G120P Cabinet

Configuration

Cable cross-sections and connections

The table below lists the recommended and maximum possible cable connections at the line and motor ends (versions A and C).

The recommended cross-sections are based on the specified fuses. They are applicable for 3-wire cables manufactured out of copper with PVC insulation, routed horizontally in air and a permissible wire temperature of 70 °C (158 °F) (e.g. Protodur NYY

or NYCWY) for an ambient temperature of 40 °C (104 °F) and individual routing.

When the conditions differ from those specified above (cable routing, cable grouping, ambient temperature), the appropriate correction factors according to IEC 60364-5-52 must be taken into account.

Rated power	Converter	Line supply connection			Motor connection			Cabinet grounding	
		Recommended cross-section ¹⁾	Maximum conductor cross-section	Fixing screw	Recommended cross-section ¹⁾	Maximum conductor cross-section	Fixing screw	Maximum conductor cross-section	Fixing screw
400 V/690 V	SINAMICS G120P Cabinet versions A and C	IEC mm ²	IEC mm ²		IEC mm ²	IEC mm ²		IEC mm ²	
kW	6SL3710- ...								
380 ... 480 V 3 AC									
75	1PE31-5AB0-Z	50	2 × 120	M12	50	2 × 120	M12	2 × 120	M12
90	1PE31-8AB0-Z	70			70				
110	1PE32-1AB0-Z	95			95				
132	1PE32-5AB0-Z	95			2 × 50				
160	1PE33-0 . A0-Z	2 × 120	2 × 240		2 × 95	2 × 240	M12 × 40 ²⁾	3 × 240	
200	1PE33-7 . A0-Z	2 × 120			2 × 95				
250	1PE34-6 . A0-Z	2 × 185			2 × 150				
315	1PE35-8 . A0-Z	2 × 240	4 × 240		2 × 185	4 × 240		6 × 240	
355	1PE36-6 . A0-Z	3 × 150			2 × 240				
400	1PE37-4 . A0-Z	3 × 185			2 × 240				
450	1PE38-4AA0-Z	4 × 185	6 × 240		4 × 150	4 × 240		6 × 240	
500	1PE38-8AA0-Z	4 × 185			4 × 150	6 × 240			
560	1PE41-0AA0-Z	4 × 240			4 × 150				
500 ... 690 V 3 AC									
315	1PG33-7 . A0-Z	2 × 120	4 × 240	M12	2 × 120	4 × 240	M12 × 40 ²⁾	6 × 240	M12
355	1PG34-0 . A0-Z	2 × 150			2 × 120				
400	1PG34-5 . A0-Z	2 × 185			2 × 150				
450	1PG35-2 . A0-Z	3 × 120			3 × 95				
500	1PG35-8AA0	2 × 240	6 × 240		2 × 185	4 × 240			
560	1PG36-5AA0	3 × 185			2 × 240				
630	1PG37-2AA0	3 × 185			2 × 240				

Cable cross-sections required for connecting to the line supply and to motors

It is always recommended to use shielded - for higher power ratings - where possible symmetrical, 3-wire three-phase cables between the converter and the motor, and where required, to connect several of these cables in parallel. There are essentially 2 reasons for this:

- Only then can the high IP55 degree of protection at the motor terminal box be easily achieved. The reason for this is that cables are routed into the terminal box through glands, and the number of possible glands is restricted by the terminal box geometry. Individual cables are less suitable in achieving this.
- With symmetrical 3-wire three-phase cables, the summed ampere-turns over the cable outer diameter are equal to zero. They can easily be routed in conductive, metal cable ducts or racks without any significant currents (ground current or leakage current) being induced in these conductive, metal connections. The danger of induced leakage currents, and thus of increased cable sheath losses, is significantly higher for single-wire cables.

The cable cross-section required depends on the current being conducted in the cable. The permissible current loading of cables is defined, for example, in IEC 60364-5-52. It depends on ambient conditions, such as temperature, but also on the routing method. It should be taken into account as to whether cables are routed individually and therefore relatively well ventilated, or whether groups of cables are routed together. In the latter case, the cables have significantly poorer ventilation and can therefore heat one another up more significantly. For the relevant correction factors applicable to these boundary conditions, please refer to IEC 60364-5-52.

The table below provides a guide to the recommended cross-sections (based on IEC 60364-5-52) for PVC-insulated, 3-wire copper and aluminum cables, a permissible conductor temperature of 70 °C (158 °F) (e.g. Protodur NYY or NYCWY), and an ambient temperature of 40 °C (104 °F).

¹⁾ The recommendations for the North American market in AWG or MCM should be taken from the appropriate NEC (National Electrical Code) or CEC (Canadian Electrical Code) standards.

²⁾ The connecting blocks can be damaged when using longer screws.

SINAMICS G120P Cabinet, converter cabinet units

SINAMICS G120P Cabinet, 75 kW to 630 kW

SINAMICS G120P Cabinet**Configuration** (continued)

Current-carrying capacity according to IEC 60364-5-52 at 40 °C (104 °F)

Cross-section 3-wire cable mm ²	Copper cable		Aluminum cable	
	Single routing A	Several cables lying next to one another ¹⁾ A	Single routing A	Several cables lying next to one another ¹⁾ A
3 × 2.5	22	17	17	13
3 × 4	30	23	23	18
3 × 6	37	29	29	22
3 × 10	52	41	40	31
3 × 16	70	54	53	41
3 × 25	88	69	68	53
3 × 35	110	86	84	65
3 × 50	133	104	102	79
3 × 70	171	133	131	102
3 × 95	207	162	159	124
3 × 120	240	187	184	144
3 × 150	278	216	213	166
3 × 185	317	247	244	190
3 × 240	374	292	287	224

Cables must be connected in parallel for higher currents.

Note:

The recommendations for the North American market in AWG or MCM should be taken from the corresponding standards NEC (National Electrical Code) or CEC (Canadian Electrical Code).

Grounding and protective conductor cross-sections

The protective conductor must be dimensioned taking into account the following data:

- In the case of a ground fault, no impermissibly high contact voltages resulting from voltage drops on the PE conductor caused by the ground fault current may occur (< 50 V AC or < 120 V DC, IEC 61800-5-1, IEC 60364, IEC 60543).
- The PE conductor should not be excessively loaded by any ground fault current it carries.
- If it is possible for continuous currents to flow through the PE conductor when a fault occurs, the PE conductor cross-section must be dimensioned for this continuous current.
- The PE conductor cross-section should be selected according to IEC 60204-1, IEC 60439-1, IEC 60364.

Cross-section, line conductor mm ²	Minimum cross-section, external protective conductor mm ²
up to 16	Minimum cross-section of external conductor
16 ... 35	16
from 35	At least half the cross-section of external conductor

Note:

The recommendations for the North American market in AWG or MCM should be taken from the corresponding standards NEC (National Electrical Code) or CEC (Canadian Electrical Code).

Switchgear and motors are usually grounded separately via a local ground electrode. With this constellation, the ground fault current flows via the parallel ground connections and is divided. In spite of the relatively small protective conductor cross-sections used in accordance with the table above, no inadmissible touch voltages occur with this grounding system. However, from experience gained with different grounding constellations, we recommend that the ground cable from the motor returns directly to the converter. For EMC reasons and to prevent bearing currents – for higher power ratings – symmetrical, 3-wire, three-phase cables should be preferentially used instead of four-wire cables. For 3-wire cables, the protection or PE wire must be routed separately or arranged symmetrically in the motor cable. The symmetry of the PE conductor is achieved using a conductor surrounding all phase conductors or using a cable with a symmetrical arrangement of the three phase conductors and three ground conductors.

Through their high-speed controllers, the converters limit the load current (motor and ground fault currents) to an rms value corresponding to the rated current. We therefore recommend the use of a PE conductor cross-section analogous to the phase conductor cross-section for grounding the control cabinet.

¹⁾ A maximum of 9 cables may be routed directly next to one another horizontally on a cable tray.

SINAMICS G120P Cabinet, converter cabinet units

SINAMICS G120P Cabinet, 75 kW to 630 kW

SINAMICS G120P Cabinet

Selection and ordering data

Rated power		Rated output current		SINAMICS G120P Cabinet converter cabinet units		
At 400 V/690 V, 50 Hz		At 400 V/690 V		(can be ordered only with Article No. <u>and</u> order code)	Control Unit (It is essential to specify one of the order codes below)	
kW	hp	A	Article No.	Order code		
380 ... 480 V 3 AC						
75	75	145	6SL3710-1PE31-5 A B0-Z	■ ■ ■		
90	100	178	6SL3710-1PE31-8 A B0-Z	■ ■ ■		
110	125	205	6SL3710-1PE32-1 A B0-Z	■ ■ ■		
132	150	250	6SL3710-1PE32-5 A B0-Z	■ ■ ■		
160	200	300	6SL3710-1PE33-0 ■ A0-Z	■ ■ ■		
200	250	370	6SL3710-1PE33-7 ■ A0-Z	■ ■ ■		
250	300	460	6SL3710-1PE34-6 ■ A0-Z	■ ■ ■		
315	400	585	6SL3710-1PE35-8 ■ A0-Z	■ ■ ■		
355	450	655	6SL3710-1PE36-6 ■ A0-Z	■ ■ ■		
400	500	735	6SL3710-1PE37-4 ■ A0-Z	■ ■ ■		
450	500	840	6SL3710-1PE38-4 A A0-Z	■ ■ ■		
500	600	910	6SL3710-1PE38-8 A A0-Z	■ ■ ■		
560	700	1021	6SL3710-1PE41-0 A A0-Z	■ ■ ■		
500 ... 690 V 3 AC						
315	350	340	6SL3710-1PG33-7 ■ A0-Z	■ ■ ■		
355	400	393	6SL3710-1PG34-0 ■ A0-Z	■ ■ ■		
400	450	430	6SL3710-1PG34-5 ■ A0-Z	■ ■ ■		
450	450	480	6SL3710-1PG35-2 ■ A0-Z	■ ■ ■		
500	500	535	6SL3710-1PG35-8 A A0-Z	■ ■ ■		
560	600	595	6SL3710-1PG36-5 A A0-Z	■ ■ ■		
630	700	665	6SL3710-1PG37-2 A A0-Z	■ ■ ■		
Version A All available line connection components can be installed as required					A	
Version C Especially space-saving design					C	
Control Unit	CU230P-2 PN				K 9 6	
	CU230P-2 DP				K 9 7	
	CU230P-2 HVAC				K 9 8	

Note:

The power data in hp units are based on the NEC/CEC standards for the North American market.

SINAMICS G120P Cabinet, converter cabinet units

SINAMICS G120P Cabinet, 75 kW to 630 kW

SINAMICS G120P Cabinet

Options

Refer also to ordering examples for orders with order codes.

Available options	Order code	Version A	Version C
		380 ... 480 V 3 AC: 75 ... 560 kW 500 ... 690 V 3 AC: 315 ... 630 kW	380 ... 480 V 3 AC: 160 ... 400 kW 500 ... 690 V 3 AC: 315 ... 450 kW
Control Unit (it is essential to specify one of these three order codes)			
CU230P-2 PN Control Unit	K96	✓	✓
CU230P-2 DP Control Unit	K97	✓	✓
CU230P-2 HVAC Control Unit	K98	✓	✓
Line-side options			
Use in the first environment according to EN 61800-3 Category C2 (TN systems or TT systems with grounded neutral point) ¹⁾	L00	✓	–
Clean Power version with integrated Line Harmonics Filter	L01	✓ ³⁾	–
Main contactor	L13	✓ ³⁾	–
Main switch, incl. fuses	L26	✓	✓
Motor-side options			
dv/dt filter compact plus VPL (Voltage Peak Limiter)	L07	✓	–
Motor reactor	L08	✓	–
Motor protection and safety functions			
EMERGENCY OFF pushbutton installed in the cabinet door	L45	✓	–
EMERGENCY OFF Category 0, 24 V DC	L57	✓ ³⁾	–
EMERGENCY STOP Category 1, 24 V DC ²⁾	L60	✓ ³⁾	–
Thermistor motor protection unit (alarm)	L83	✓ ³⁾	–
Thermistor motor protection unit (trip)	L84	✓ ³⁾	–
Pt100 evaluation unit	L86	✓ ³⁾	–
Safety Integrated			
Stop Category 0 (STO)	K83	✓	✓
Stop Category 1 (SS1)	K84	✓	✓
Degree of protection increase			
Degree of protection IP21	M21	✓ ⁴⁾	✓
Degree of protection IP23	M23	✓ ³⁾	✓
Degree of protection IP43	M43	✓ ³⁾	✓
Degree of protection IP54	M54	✓ ³⁾	✓
Mechanical options			
Base 100 mm high	M06	✓	✓
Cable compartment 200 mm high, RAL 7035	M07	✓	✓
Other options			
Switchover to a 120 V AC auxiliary power supply	K69	✓	✓
Provision of a cabinet-internal 230 V AC auxiliary power supply	K74	✓	–
Connection for external auxiliary equipment	L19	✓ ³⁾	–
Cabinet lighting with service socket	L50	✓	✓
Cabinet anti-condensation heating	L55	✓	✓
Braking unit for line voltages 380 V ... 480 V	L62	✓	–
One-line label for system identification, 40 × 80 mm (1.57 × 3.15 in) ⁵⁾	Y31	✓	✓
Two-line label for system identification, 40 × 180 mm (1.57 × 7.09 in) ⁵⁾	Y32	✓	✓
Four-line label for system identification, 40 × 180 mm (1.57 × 7.09 in) ⁵⁾	Y33	✓	✓

✓ Option that can be ordered

– Option that cannot be ordered

¹⁾ Applies to shielded motor cable lengths ≤150 m (492 ft).

²⁾ The stopping requirements must be taken into account with this option. Additional braking units may be required.

³⁾ If there is no 230 V AC power supply in the customer installation, it is essential to select option **K74** in order to ensure proper functioning of the option.

⁴⁾ If there is no 230 V AC power supply in the customer installation, it is essential that option **K74** be selected in order to ensure power supply to the fan for frame sizes F, HX and JX.

⁵⁾ The order code **Y..** requires data in plain text.

SINAMICS G120P Cabinet, converter cabinet units

SINAMICS G120P Cabinet, 75 kW to 630 kW

SINAMICS G120P Cabinet

Options (continued)

Available options	Order code	Version A	Version C
		380 ... 480 V 3 AC: 75 ... 560 kW 500 ... 690 V 3 AC: 315 ... 630 kW	380 ... 480 V 3 AC: 160 ... 400 kW 500 ... 690 V 3 AC: 315 ... 450 kW
Documentation (standard: English/German)			
Customer documentation (circuit diagram, terminal diagram, layout diagram) in DXF format	D02	✓	✓
Customer documentation as hard copy	D04	✓	✓
Preliminary version of customer documentation	D14	✓	✓
Documentation language: English/French	D58	✓	✓
Documentation language: English/Spanish	D60	✓	✓
Documentation language: English/Italian	D80	✓	✓
Documentation language: English/Chinese	D91	✓	✓
Documentation language: English/Russian	D94	✓	✓
Languages (standard: English/German)			
Rating plate data in English/French	T58	✓	✓
Rating plate data in English/Spanish	T60	✓	✓
Rating plate data in English/Italian	T80	✓	✓
Rating plate data in English/Russian	T85	✓	✓
Rating plate data in English/Chinese	T91	✓	✓
Device acceptance inspections in presence of customer			
Visual acceptance	F03	✓	✓
Function test with no motor connected	F71	✓	✓
Function test with test bay motor under no-load conditions	F75	✓	✓
Insulation test	F77	✓	✓
Customer-specific acceptance inspections (on request)	F97	✓	✓
Device acceptance inspections without presence of customer			
Function test with no motor connected	F72	✓	✓
Function test with test bay motor under no-load conditions	F74	✓	✓
Insulation test	F76	✓	✓
Extension of the liability for defects			
Extension of the liability for defects by 12 months to a total of 24 months from delivery	Q80	✓	✓
Extension of the liability for defects by 18 months to a total of 30 months from delivery	Q81	✓	✓
Extension of the liability for defects by 24 months to a total of 36 months from delivery	Q82	✓	✓
Extension of the liability for defects by 30 months to a total of 42 months from delivery	Q83	✓	✓
Extension of the liability for defects by 36 months to a total of 48 months from delivery	Q84	✓	✓
Extension of the liability for defects by 48 months to a total of 60 months from delivery	Q85	✓	✓

SINAMICS G120P Cabinet, converter cabinet units

SINAMICS G120P Cabinet, 75 kW to 630 kW

SINAMICS G120P Cabinet**Options** (continued)**Option selection matrix**

Certain options are mutually exclusive. The tables below only provide an overview. Please refer to the descriptions of the individual options for a precise description of options and other exclusions.

Interdependencies of mechanical and electrical options

	L00	L01	L07	L08	L13	L19	L26	L45	L50	L55	L57	L60	L62	L83	L84	L86
L00		✓	✓	✓	✓	✓	✓	✓	✓	✓	✓	✓	✓	✓	✓	✓
L01	✓		✓	✓	✓	✓	✓	✓	✓	✓	✓	✓	✓	✓	✓	✓
L07	✓	✓		–	✓	✓	✓	✓	✓	✓	✓	✓	–	✓	✓	✓
L08	✓	✓	–		✓	✓	✓	✓	✓	✓	✓	✓	–	✓	✓	✓
L13	✓	✓	✓	✓		✓	✓	✓	✓	✓	1)	1)	✓	✓	✓	✓
L19	✓	✓	✓	✓	✓		✓	✓	✓	✓	✓	✓	✓	✓	✓	✓
L26	✓	✓	✓	✓	✓	✓		✓	✓	✓	✓	✓	✓	✓	✓	✓
L45	✓	✓	✓	✓	✓	✓	✓		✓	✓	✓	✓	✓	✓	✓	✓
L50	✓	✓	✓	✓	✓	✓	✓	✓		✓	✓	✓	✓	✓	✓	✓
L55	✓	✓	✓	✓	✓	✓	✓	✓	✓		✓	✓	✓	✓	✓	✓
L57	✓	✓	✓	✓	1)	✓	✓	✓	✓	✓		–	✓	✓	✓	✓
L60	✓	✓	✓	✓	1)	✓	✓	✓	✓	✓	–		2)	✓	✓	✓
L62	✓	✓	–	–	✓	✓	✓	✓	✓	✓	✓	2)		✓	✓	✓
L83	✓	✓	✓	✓	✓	✓	✓	✓	✓	✓	✓	✓	✓		✓	✓
L84	✓	✓	✓	✓	✓	✓	✓	✓	✓	✓	✓	✓	✓	✓		✓
L86	✓	✓	✓	✓	✓	✓	✓	✓	✓	✓	✓	✓	✓	✓	✓	

Dependencies of Safety options

	K83	K84
K83		–
K84	–	

- ✓ Combination possible
- Combination not possible

1) The options **L57** and **L60** always require option **L13**.

2) Option **L60** requires a braking unit for rapid standstill of the motor (option **L62**).

Options (continued)

Ordering examples

Example 1

Task:

A converter cabinet unit is needed to control the fan speed for a 180 kW fan drive for connecting to an existing 400 V MCC outgoing circuit. The rated speed of the fan is 975 rpm. Due to the prevailing ambient conditions, the converter must be mounted on a 100 mm (3.94 in) cabinet base and have IP54 degree of protection. The installation altitude is <1000 m (3281 ft) above sea level, the ambient temperature is 45 °C (113 °F).

Solution:

Because an MCC outgoing circuit already exists, the line connection components, such as main switch, main contactor and line fuses, can be omitted and the space-saving version C can be selected. A single-phase 230 V connection for the auxiliary power supply inside the converter cabinet is not required with this configuration. Taking into account the 7.5 % derating factor for the increased ambient temperature, a converter cabinet unit with 200 kW, 400 V is sufficient for this application.

The increased degree of protection and installation altitude do not necessitate additional derating. In total, the following additional options are required:

K96-K98 (selection of a fieldbus option on the CU) – required option

M06 (100 mm (3.94 in) cabinet base)

M54 (degree of protection IP54).

The information to be stated on the order is therefore (taking PROFINET as an example):

6SL3710-1PE33-7CA0-Z
+K96 +M06 +M54

Example 2

Task:

A 160 kW pump to control the pressure equalization is to be supplied via a converter for a brand new district heating pumping station. A 400 V supply is available. The installation altitude is 350 m (1148 ft) above sea level and the ambient temperature is maximum 35 °C (95 °F). The rated speed of the pump is 740 rpm. Since the pump unit with the motor is installed in an unmanned remote station, the possibility of low ambient temperatures with risk of condensation cannot be excluded.

A PROFIBUS connection must be provided to allow remote monitoring of the converter. The customer wants a ready-to-connect converter that includes a main switch, fuses and contactors for safe disconnection from the supply. The converter must also be equipped with a 230 V AC service socket and cabinet lighting system.

Solution:

An anti-condensation heating system must be provided in order to protect the converter against condensation caused by low ambient temperatures. To keep the heating system operational at all times, an external 230 V AC supply is required. The same applies to the service socket and lighting system options. Since an external 230 V AC supply is already available, there is no need to order option **K74** to supply the contactor control circuit. A converter cabinet unit 160 kW, 400 V, version A, with the following options must be selected for this application:

K97 (CU230P-2 DP Control Unit),

L13 (main contactor),

L26 (main switch including fuses),

L50 (cabinet lighting system with service socket) and

L55 (cabinet anti-condensation heating system)

The information to be stated on the order is therefore:

6SL3710-1PE33-0AA0-Z
+K97 +L13 +L26 +L50 +L55

Description of options

D02

Customer documentation (circuit diagram, terminal diagram, layout diagram) in DXF format

This option can be used to order documents such as circuit diagrams, terminal diagrams, layout diagrams, and dimension drawings in DXF format, in order to process them further in CAD systems, for example. They are supplied on the documentation DVD in the desired language (standard is English/German, for other languages, see options **D58, D60, D80, D91, D94**).

D04

Customer documentation as hard copy

Equipment documentation is supplied electronically on DVD-ROM as standard. If the customer also requires a hard copy of the documentation and selects option **D04**, the following documents will be shipped in a folder with the converter:

- Operating instructions
- Circuit diagram
- Terminal diagram
- Layout diagram
- Dimension drawing
- Spare parts list
- Test certificate

Regardless of whether option **D04** is selected, a hard copy of the safety and transportation guidelines and a registration form are always supplied.

D14

Preliminary version of customer documentation

If documents such as circuit diagrams, terminal diagrams, layout diagrams and dimensional drawings are required in advance for the purpose of system engineering (integration of drive into higher-level systems, interface definition, installation, building planning, etc.), it is possible to order a preliminary copy of the documentation with the G120P Cabinet. These documents are then supplied electronically a few working days following receipt of the order. If the order includes options that fall outside the scope of standard delivery, these will not be covered by the documentation due to the obvious time constraints.

The client is sent the documentation relating to the order by email. The recipient's email address must be specified with the order for this purpose. In the email, the recipient will also receive a link for downloading order-specific documentation. With option **D02**, the documents are also delivered in DXF format.

D58, D60, D80, D91, D94

Documentation as language package

If a documentation option is not selected, the relevant documentation is supplied as standard in English/German. When one of the options specified in the table is selected, the standard documentation language will be changed from English/German to the language combination provided by the option.

Order code	Language
D58	English/French
D60	English/Spanish
D80	English/Italian
D91	English/Chinese
D94	English/Russian

SINAMICS G120P Cabinet, converter cabinet units

SINAMICS G120P Cabinet, 75 kW to 630 kW

SINAMICS G120P Cabinet

Options (continued)

F03, F71, F75, F77, F97

Equipment acceptance in the presence of the customer

F72, F74, F76

Equipment acceptance without the presence of the customer

Option	Description
F03	<p>Visual acceptance</p> <p>The tests are carried out with the converter de-energized. The following is included in the scope of the acceptance tests:</p> <ul style="list-style-type: none"> • Checking the degree of protection • Checking the equipment (components) • Checking the equipment identifiers • Checking clearance and creepage distances • Checking cables • Checking customer documentation • Submission of the acceptance report
F71, F72	<p>Function test with no motor connected</p> <p>After the visual inspection with the converter switched off, the converter is connected to rated voltage. No current at the converter output end.</p> <p>The following is included in the scope of the acceptance tests:</p> <ul style="list-style-type: none"> • Visual inspection as described for option F03 • Checking power supply • Checking protective and monitoring devices (simulation) • Checking fans • Precharging test • Function test without connected motor • Submission of the acceptance report
F74, F75	<p>Function test with test bay motor under no-load conditions</p> <p>After the visual inspection with the converter switched off, the converter is connected to rated voltage. A small current flows at the converter's output in order to operate the test bay motor under no-load conditions.</p> <p>The following is included in the scope of the acceptance tests:</p> <ul style="list-style-type: none"> • Visual inspection as described for option F03 • Checking power supply • Checking protective and monitoring devices (simulation) • Checking fans • Function test with test bay motor under no-load conditions • Submission of the acceptance report
F76, F77	<p>Acceptance of insulation test of the converter</p> <p>The following is included in the scope of the acceptance tests:</p> <ul style="list-style-type: none"> • High-voltage test • Measurement of the insulation resistance • Submission of the acceptance report
F97	<p>Customer-specific system acceptance tests (on request)</p> <p>If acceptance tests are desired which are not covered by the options F03, F71/F72, F74/F75 or F76/F77, customer-specific acceptance tests/supplementary tests can be ordered using order code F97 on request and following technical clarification.</p>

K69

Switchover to a 120 V AC auxiliary power supply

With this option, the supply voltage range is adjusted to all relevant loads in the control cabinet to 110 V AC to 120 V AC, e.g. for fans and monitoring devices.

If the supply voltage is made available in the cabinet via the option **K74**, the voltage range is also adjusted to 110 V to 120 V.

K74

Provision of a cabinet-internal 230 V AC auxiliary power supply

If there is no 230 V AC power supply in the customer installation, option **K74** can be used to provide a cabinet-internal auxiliary power supply for the required auxiliary voltages of the external control circuits of the cabinet unit. The auxiliary voltages are generated by a transformer.

Note:

If there is no 230 V AC power supply in the customer installation, it is essential to select option **K74** in order to ensure proper functioning of the options **L01, L13, L19, L57, L60, L83, L84** and **L86** and for the options **M23, M43** and **M54** for cabinet version A and for option **M21** for cabinet version A, frame sizes F and HX!

Options **L50** and **L55** always require an external supply voltage and must not be supplied via option **K74**.

K83

Stop Category 0 (STO)

This option enables the Safe Torque Off (STO) safety function for the drive.

The implemented safety technology allows for short-circuit and cross-circuit detection. Connection contacts are provided for the user on a terminal block for connecting two channel safety sensors. A start or acknowledgement button can also be connected via terminal block.

K84

Stop Category 1 (SS1)

This option enables time-controlled braking of the motor (SS1) according to a braking ramp (0,5 - 30 s) with subsequent Safe Torque Off (STO).

The implemented safety technology allows for short-circuit and cross-circuit detection. Connection contacts are provided for the user on a terminal block for connecting two channel safety sensors. A start or acknowledgement button can also be connected via terminal block.

K96

CU230P-2 Control Unit PROFINET, EtherNet/IP

The converter is shipped with a CU230P-2 PN Control Unit (PROFINET).

For more information about the CU230P-2 PN Control Unit, refer to SINAMICS G120P built-in and wall-mounted units.

K97

CU230P-2 Control Unit PROFIBUS

The converter is shipped with a CU230P-2 DP Control Unit (PROFIBUS).

For more information about the CU230P-2 DP Control Unit, refer to SINAMICS G120P built-in and wall-mounted units.

K98

CU230P-2 HVAC Control Unit

The converter is shipped with a CU230P-2 HVAC Control Unit (USS, Modbus RTU, BACnet MS/TP, FLN P1).

For more information about the CU230P-2 HVAC Control Unit, refer to SINAMICS G120P built-in and wall-mounted units.

SINAMICS G120P Cabinet, converter cabinet units

SINAMICS G120P Cabinet, 75 kW to 630 kW

SINAMICS G120P Cabinet

Options (continued)

L00

Use in the first environment to EN 61800-3, Category C2 (TN systems or TT systems with grounded neutral point)

To limit the **emitted interference**, the converters are equipped as standard with a radio interference suppression filter that conforms to the limits defined in Category C3. SINAMICS G120P Cabinet units equipped with the line filter also meet the limits for use in the first environment (Category C2) as specified in EN 61800-3.¹⁾

SINAMICS G120P Cabinet units comply with the **noise immunity** requirements defined in EN 61800-3 as standard for the first and second environments.

In conjunction with line reactors, line filters also limit the conducted interference emitted by the Power Modules to the limit values of Category C2 defined in product standard EN 61800-3.

To allow the power cable shield to be connected in conformance with EMC requirements, an additional EMC shield bus (**M70** option) is installed in the cabinet. A separate order is not required in this case.

Note:

Option **L00** increases the cabinet width for frame size JX by 200 mm (7.87 in).

L01

Clean Power version with integrated Line Harmonics Filter



The Clean Power version of SINAMICS G120P Cabinet is equipped with an innovative Line Harmonics Filter. This filter allows an effective limitation of the line-side harmonic components arising in converters with a B6 bridge circuit as a result of their principle of operation. As a result of the significant reduction of these low-frequency interference variables, voltage distortion can be effectively counteracted at the line connection point and thus consistently limited to a value of below 5 % distortion rate (THD). The limit values stipulated in standard IEEE 519-1992 are complied with without exception where network rigidity is sufficient ($R_{SC} > 20$ is required).

By exclusively using passive and thus very robust filter components, the Line Harmonics Filter in the SINAMICS G120P Cabinet delivers extremely high availability and maximum energy efficiency. Furthermore, the filter can remain connected to the line even when the converter is in stand-by mode by means of a built-in LC element decoupling circuit. Standard power disconnection by means of a main contactor (option **L13**) is still available on request, but is no longer a mandatory requirement. Thanks to the modular design of the SINAMICS G120P Cabinet, the Clean Power Filter can be easily combined with the basic cabinet in an additional cabinet.

The Line Harmonics Filter can be obtained for all available power ratings in two voltages ranges:

- 380 V to 415 V 3 AC ± 10 % (please note voltage limit)
- 500 V to 690 V 3 AC ± 10 %

Notice:

When using option **L01** on 60 Hz line supplies, a limited voltage tolerance of +8 % applies!

Notice:

If there is no 230 V AC power supply in the customer installation, it is essential to select option **K74** in order to ensure proper functioning of option **L01**.

The table below specifies the widths and weights of supplementary cabinets for the Clean Power version of SINAMICS G120P Cabinet units (option **L01**).

Article No.	Rated power kW	Width of supplementary cabinet mm (in)	Weight of supplementary cabinet kg (lb)
Z = +L01			
380 ... 415 V 3 AC			
6SL3710-1PE31-5AB0-Z	75	400 (15.75)	400 (882)
6SL3710-1PE31-8AB0-Z	90	400 (15.75)	400 (882)
6SL3710-1PE32-1AB0-Z	110	400 (15.75)	400 (882)
6SL3710-1PE32-5AB0-Z	132	400 (15.75)	400 (882)
6SL3710-1PE33-0AA0-Z	160	400 (15.75)	460 (1014)
6SL3710-1PE33-7AA0-Z	200	400 (15.75)	460 (1014)
6SL3710-1PE34-6AA0-Z	250	400 (15.75)	460 (1014)
6SL3710-1PE35-8AA0-Z	315	600 (23.62)	600 (1323)
6SL3710-1PE36-6AA0-Z	355	600 (23.62)	600 (1323)
6SL3710-1PE37-4AA0-Z	400	600 (23.62)	600 (1323)
6SL3710-1PE38-4AA0-Z	450	800 (31.5)	800 (1764)
6SL3710-1PE38-8AA0-Z	500	800 (31.5)	800 (1764)
6SL3710-1PE41-0AA0-Z	560	800 (31.5)	800 (1764)
500 ... 690 V 3 AC			
6SL3710-1PG33-7AA0-Z	315	600 (23.62)	600 (1323)
6SL3710-1PG34-0AA0-Z	355	600 (23.62)	600 (1323)
6SL3710-1PG34-5AA0-Z	400	600 (23.62)	600 (1323)
6SL3710-1PG35-2AA0-Z	450	600 (23.62)	600 (1323)
6SL3710-1PG35-8AA0-Z	500	800 (31.5)	800 (1764)
6SL3710-1PG36-5AA0-Z	560	800 (31.5)	800 (1764)
6SL3710-1PG37-2AA0-Z	630	800 (31.5)	800 (1764)

To allow the power cable shield to be connected in conformance with EMC requirements, an EMC shield bus is installed in the cabinet at the factory.

¹⁾ Applies to shielded motor cable lengths ≤ 150 m (492 ft).

SINAMICS G120P Cabinet, converter cabinet units

SINAMICS G120P Cabinet, 75 kW to 630 kW

SINAMICS G120P Cabinet

Options (continued)

L07

dv/dt filter compact plus VPL

dv/dt filters compact plus VPL (**V**oltage **P**eak **L**imiter) limit the voltage rate-of-rise dv/dt to values of < 1600 V/μs and the typical voltage peaks to the following values according to the limit value curve A to IEC 60034-25: 2007:

- < 1150 V at $U_{\text{line}} < 575 \text{ V}$
- < 1400 V at $660 \text{ V} < U_{\text{line}} < 690 \text{ V}$

The dv/dt filter compact plus VPL functionally consists of two components, the dv/dt reactor and the voltage limiting network (VPL), which limits voltage peaks and feeds the energy back to the DC link. Its dimensions are so compact that it can be completely integrated in the cabinet – even for high power ratings. A supplementary cabinet is not required.

The use of a dv/dt filter compact plus VPL represents a suitable method of reducing the voltage load on the motor winding for line supply voltages up to 690 V to such an extent that special motor insulation is not required. The bearing currents are also significantly reduced, meaning that standard motors without insulated bearings can also be operated on the SINAMICS G120P Cabinet for all grid connection voltages up to 690 V. This applies to both Siemens motors and third-party motors. The voltage drop across the dv/dt filter compact plus VPL is approximately only 1 %.

dv/dt filters can be used in both grounded (TN/TT) and non-grounded (IT) systems.

dv/dt filters compact plus VPL are designed for the following maximum motor cable lengths:

- Shielded cables 100 m (328 ft) (e.g. Protodur NYCWY)
- Non-shielded cables 150 m (492 ft) (e.g. Protodur NYY)

Solutions for longer cable lengths (> 100 m (328 ft) shielded, > 150 m (492 ft) unshielded) are available on request.

Notice:

Operation with output frequencies < 10 Hz is permissible for max. 5 min.

Note:

Option **L07** cannot be combined with the following options:

- **L08** (motor reactor)

Note:

For converter cabinet units with a rated power from 160 kW, for space reasons, the option **L62** is not immediately available when output options **L07** or **L08** are used. This combination is only available as a special version on request.

L08

Motor reactor

The following applications require the use of a motor reactor:

- Group drives
- Ensuring uninterrupted operation on IT networks in the event of a single-phase short-circuit (only applies to cabinet units with a power rating of up to 132 kW)
- Increasing the motor cable length to the following values:
 - Shielded cables 300 m (984 ft) (e.g. Protodur NYCWY)
 - Non-shielded cables 450 m (1476 ft) (e.g. Protodur NYY)

The values specified are to be understood as guide values, the actual values depend on the cable type and routing. Solutions for longer cable lengths (> 300 m (984 ft) shielded, > 450 m (1476 ft) unshielded) are available on request.

Fundamentally, motor reactors reduce the voltage load on the motor windings by reducing the voltage gradients at the motor terminals that occur during converter operation. At the same time, the capacitive charge/discharge currents that occur at the converter output when long motor cables are used are reduced. In this respect, the use of motor reactors with long cable lengths can have a positive effect on the life expectancy of the motor and the converter.

The reduced voltage rise in the output circuit also attenuates the bearing currents in the motor. However, this reduction is usually not sufficient to be able to dispense with the use of an insulated NDE bearing in the motor.

In the case of line voltages from 500 V to 690 V, the use of a pure motor reactor is generally not suitable for improving the increased winding load on the motor by converter operation to such an extent that special insulation in the motor can be dispensed with. Such an improvement can only be achieved with a dv/dt filter (option **L07**).

Note:

Option **L08** cannot be combined with the following options:

- **L07** (dv/dt filter compact plus VPL)

Note:

For converter cabinet units with a rated power from 160 kW, for space reasons, the option **L62** is not immediately available when output options **L07** or **L08** are used. This combination is only available as a special version on request.

L13

Main contactor

SINAMICS G120P Cabinet converter cabinet units, versions A and C can be used with a main contactor. Option **L13** is needed if a switching element is required for disconnecting the cabinet from the supply (required for EMERGENCY OFF). The contactor is controlled internally in the converter. Option **L13** always also covers the installation of a SITOP 24 V DC power module to be able to keep the converter in stand-by mode.

Notice:

If there is no 230 V AC power supply in the customer installation, it is essential to select option **K74** in order to ensure proper functioning of option **L13**.

Options (continued)

L19

Connection for external auxiliary equipment

With this option, a controlled outgoing feeder fused with max. 10 A for external auxiliary equipment (e.g. separately driven fan for motors) is provided in the cabinet. The outgoing feeder can either be controlled internally in the converter or externally (customer-specific).

The 3 AC supply voltage for the external auxiliary equipment is tapped from the line connection side in the cabinet and therefore corresponds to the nominal value of the mains connection voltage.

Additional connection points are available for feedback contacts of motor circuit breakers and the control contactor.

Caution:

If there is no 230 V AC power supply in the customer installation, it is essential to select option **K74** in order to ensure proper functioning of option **L19**.

L26

Main switch incl. fuses

A switch disconnecter with fuses is available as main switch. Switch disconnectors offer reliable personnel protection and consistently help to prevent electrical accidents. Maintenance or expansion work can be performed hazard-free on open control cabinets thanks to safe voltage disconnection. Unwanted or unauthorized switching can be reliably prevented with a suitable locking function.

SINAMICS G120P Cabinet converter cabinet units are reliably protected against overload and short-circuit by the combination of switch disconnectors and quick-acting semiconductor fuses. For this reason, only high-quality Siemens SITOR semiconductor fuses are deployed for all power ratings and line voltage levels.

L45

EMERGENCY OFF pushbutton, installed in the cabinet door

The EMERGENCY OFF button with protective collar is installed in the converter cabinet door and its contacts are connected to the terminal block. The EMERGENCY OFF functions of Category 0 or 1 can be activated in conjunction with options **L57** and **L60**.

Notice:

By pressing the EMERGENCY OFF pushbutton, in compliance with EN 60204-1, the motor is stopped – either uncontrolled or controlled depending on the selected Category 0 or 1 – and the converter isolated from the line supply. Auxiliary voltages, such as the cabinet-internal 230 V AC auxiliary power supply (option **K74**), may still be present. Certain areas within the converter also remain live, e.g. the control or auxiliaries. If complete disconnection of all voltages is required, the EMERGENCY OFF button must be incorporated into a protective system to be implemented by the customer. For this purpose, an NC contact is provided at terminal –X120.

The EMERGENCY OFF button is preconfigured at the factory only when one of the options **L57** or **L60** is selected simultaneously. Other circuit arrangements must be implemented in the customer installation.

L50

Cabinet lighting with service socket

Optionally, cabinet lighting and a service socket for a SCHUKO connector (plug type F) can be installed in every SINAMICS G120P Cabinet unit according to CEE 7/4 for the power supply of electrically operated tools or auxiliary devices.

The cabinet lighting consists of an LED hand lamp with an On/Off switch and magnetic fasteners. The lamp connecting cable is approximately 3 m (9.84 ft) long. The lamp is factory-positioned in the cabinet door at a defined marking, and the connecting cable is wound on the associated mount.

In order to be able to operate the handheld lamp and socket even when the cabinet is switched off, the voltage supply (at terminal strip –X390) must be provided externally with a separate line input. The AC supply can be freely selected within the range of 110 to 230 V AC and must be fused with max. 10 A.

L55

Anti-condensation heating for cabinet

The anti-condensation heating is recommended at low ambient temperatures and high levels of humidity to prevent condensation. A 100 W electrical cabinet heater is installed for each cabinet section (two heaters are installed for each section for cabinet section widths from 800 mm to 1200 mm).

The power supply for the anti-condensation heating (110 V to 230 V AC, at terminal block –X240) must be provided externally from a 230 V AC power supply and fused with max. 16 A.

Terminal –X240:	Significance
1	L1 (110 ... 230 V AC)
2	N
3	PE

L57

EMERGENCY OFF Category 0, 24 V DC

EMERGENCY OFF Category 0 for uncontrolled stopping in accordance with EN 60204-1.

The function includes interrupting the power feed for the converter via the line contactor and bypassing the microprocessor controller using a safety combination according to EN 60204-1. The motor coasts down.

Notice:

If there is no 230 V AC power supply in the customer installation, it is essential to select option **K74** in order to ensure proper functioning of option **L57**.

Notice:

Option **L57** always requires the electrical separation from the line supply, i.e. option **L13**.

Terminal –X120:	Significance
3	Looping in of the EMERGENCY STOP button from the customer installation; remove jumper 3-6!
6	Looping in of the EMERGENCY STOP button from the customer installation; remove jumper 3-6!
7	"On" for monitored start; remove jumper 15-16!
8	"On" for monitored start; remove jumper 15-16!

SINAMICS G120P Cabinet, converter cabinet units

SINAMICS G120P Cabinet, 75 kW to 630 kW

SINAMICS G120P Cabinet

Options (continued)

L60

EMERGENCY STOP Category 1, 24 V DC

EMERGENCY STOP Category 1 for controlled stopping in accordance with EN 60204-1.

The function stops the drive using a fast stop along a down ramp that is parameterized by the user. The power feed to the converter is then interrupted as described for EMERGENCY OFF Category 0.

Notice:

If there is no 230 V AC power supply in the customer installation, it is essential to select option **K74** in order to ensure proper functioning of option **L60**.

In order to maintain the specified stopping times, it may be necessary to use a braking unit (option **L62**).

Notice:

Option **L60** always requires the electrical separation from the line supply, i.e. option **L13**.

Terminal -X120:	Significance
3	Looping in of the EMERGENCY STOP button from the customer installation; remove jumper 3-6!
6	Looping in of the EMERGENCY STOP button from the customer installation; remove jumper 3-6!
7	"On" for manual start; remove jumper 15-16!
8	"On" for manual start; remove jumper 15-16!

L62

Braking unit

A braking unit must be installed for systems with large moments of inertia that require controlled braking or shutdown of the drive. When braking the motor and the load, excess energy is fed back into the converter. As a result, the DC link voltage rises. The converter transfers the excess energy to the externally mounted braking resistor.

A braking unit is also necessary when systems must come to a standstill in a specified time, as is normally required for EMERGENCY STOP Category 1 (option **L60**) or if direction reversal can occur when restarting following an intermediate standstill.

The braking unit comprises two functional elements:

- A dedicated braking module
- A braking resistor to be mounted externally (IP20 degree of protection)

The braking energy is converted into heat in the braking resistor that must be mounted externally.

A max. cable length of 10 m (32.8 ft) is permissible between the Braking Module and the braking resistor for frame sizes F and 100 m (328 ft) for frame sizes GX to JX. This allows the braking resistor to be mounted externally so that heat losses can be dissipated outside the converter enclosure.

Characteristic curves

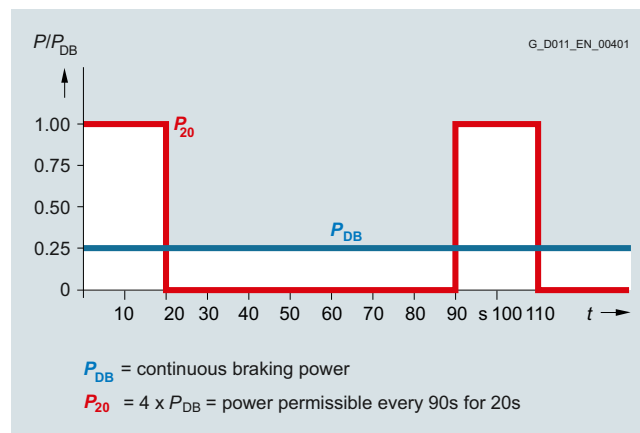

Load diagram for Braking Module and braking resistor

The following braking units are available for SINAMICS G120P Cabinet:

Order code	SINAMICS G120P Cabinet converter cabinet units	Braking Module		Braking resistor
Option	Rated power kW	P_{DB} kW	P_{20} kW	R_B Ω
380 ... 480 V 3 AC				
L62	75 ... 90	3.85	15.4	7.1 ± 7 %
	110 ... 132	5.5	22	5 ± 7 %
	160 ... 560	50	200	3.1 ± 8 %

P_{DB} : Rated power (continuous braking power).

P_{20} : 20 s power referred to a braking interval of 90 s.

Note:

For converter cabinet units with a rated power from 160 kW, for space reasons, the option **L62** is not immediately available when output options **L07** or **L08** are used. This combination is only available as a special version on request.

L83

Thermistor motor protection unit (alarm)

Thermistor motor protection device for single-channel PTC temperature sensors (PTC resistors, type A) for alarm.

The thermistor motor protection unit is supplied with power and evaluated internally in the converter. There is galvanic isolation between the supply voltage and the temperature measuring circuit.

Note:

The Control Unit has a monitoring channel to monitor the motor temperature as standard. This single-channel input supports PTC, KTY84, Pt1000 and also thermoclick sensors. The warning and fault thresholds are parameterizable. The temperature values acquired are automatically used for high-precision motor control.

Caution:

If there is no 230 V AC power supply in the customer installation, it is essential to select option **K74** in order to ensure proper functioning of option **L83**.

Options (continued)

L84

Thermistor motor protection unit (trip)

Thermistor motor protection device for single-channel PTC temperature sensors (PTC resistors, type A) for trip.

The thermistor motor protection unit is supplied with power and evaluated internally in the converter. There is galvanic isolation between the supply voltage and the temperature measuring circuit.

Note:

The Control Unit has a monitoring channel to monitor the motor temperature as standard. This single-channel input supports PTC, KTY84, Pt1000 and also thermoclick sensors. The warning and fault thresholds are parameterizable. The temperature values acquired are automatically used for high-precision motor control.

Caution:

If there is no 230 V AC power supply in the customer installation, it is essential to select option **K74** in order to ensure proper functioning of option **L84**.

L86

PT100 evaluation unit

The Pt100 evaluation unit can monitor up to 6 temperature sensors. The following sensor types are supported: Pt100, Pt1000, KTY84, NTC and thermocouples.

The sensors can be connected in a two- or three-wire system. The limit values can be freely programmed for each channel. In the factory setting, the measuring channels are subdivided into two groups, each with 3 channels. With motors, for example, this means that three Pt100s in the stator windings and two Pt100s in the motor bearings can be monitored. Unused channels can be suppressed via parameters.

The output relays are integrated into the internal fault and shutdown sequence of the converter. There is galvanic isolation between the supply voltage and the temperature measuring circuit.

The Control Unit has a monitoring channel to monitor the motor temperature as standard. This single-channel input supports PTC, KTY84, Pt1000 and also thermoclick sensors. The warning and fault thresholds are parameterizable. The temperature values acquired are automatically used for high-precision motor control.

Caution:

If there is no 230 V AC power supply in the customer installation, it is essential to select option **K74** in order to ensure proper functioning of option **L86**.

M06

Base 100 mm high

The additional cabinet base allows larger bending radii for cables (cable entry from below) and enables them to be routed within the cabinet base. It is delivered completely assembled with the cabinet. The mounting height of the operator panel changes accordingly.

M07

Cable compartment 200 mm high, RAL 7035

The cable compartment is made of strong sheet steel and allows cables to be connected more flexibly (entry from below). It also allows routing of cables within the compartment. It is delivered completely assembled with the cabinet. The mounting height of the operator panel changes accordingly.

Note:

The cable compartment is coated as standard in RAL 7035.

M21

IP21 degree of protection

For converter cabinet units up to a rated power of 132 kW, the height of the cabinet does not increase as a result of the increase in degree of protection.

In the case of converter cabinet units with a rated output of 160 kW and above, the cabinet height is increased by 300 mm (11.81 in) with a raised roof or drip plate.

For transport reasons, the top or drip protection covers are delivered separately and must be fitted on site.

Note:

The top or drip protection covers are painted in RAL 7035 as standard.

Caution:

If there is no 230 V AC power supply in the customer installation, it is essential that option **K74** be selected in order to ensure power supply to the fan for frame sizes F, HX (version A) and JX.

M23, M43, M54

Degrees of protection IP23, IP43, IP54

For converter cabinet units up to a rated power of 132 kW, the height of the cabinet does not increase as a result of the increase in degree of protection.

For converter cabinet units with a rated output of 160 kW or higher, the cabinet height is increased by 400 mm (15.7 in) when the options **M23**, **M43** or **M54** are selected.

For transport reasons, the hoods are delivered separately and must be fitted by the customer.

Note:

The roof sections are colored RAL 7035 as standard. The molded plastic parts (e.g. ventilation grilles) have color RAL 7035 and cannot be coated.

Notice:

If there is no 230 V AC power supply in the customer installation for version A, it is essential to select option **K74** in order to provide a power supply to the fan.

SINAMICS G120P Cabinet, converter cabinet units

SINAMICS G120P Cabinet, 75 kW to 630 kW

SINAMICS G120P Cabinet

Options (continued)

Q80 to Q85

Extension of the liability for defects

It is possible to extend the liability for defect periods beyond the standard liability for defects period. The standard liability for defects period as listed in the standard conditions for the supply of services and products is 12 months.

The following extension periods are available:

Extension of the liability for defects period for converters	
Order No. supplement -Z with order code	Additional text
Q80	Extension of the liability for defects period by 12 months to a total of 24 months (2 years) from delivery
Q81	Extension of the liability for defects period by 18 months to a total of 30 months (2½ years) from delivery
Q82	Extension of the liability for defects period by 24 months to a total of 36 months (3 years) from delivery
Q83	Extension of the liability for defects period by 30 months to a total of 42 months (3½ years) from delivery
Q84	Extension of the liability for defects period by 36 months to a total of 48 months (4 years) from delivery
Q85	Extension of the liability for defects period by 48 months to a total of 60 months (5 years) from delivery

The currently valid conditions for extending the period of liability for defects can be found at

<https://support.industry.siemens.com/cs/document/56715113>

T58, T60, T80, T85, T91

Rating plate data

As standard, the rating plate is in English/German.

A rating plate in another language can be selected using the following order code for the option.

Order code	Rating plate language
T58	English/French
T60	English/Spanish
T80	English/Italian
T85	English/Russian
T91	English/Chinese

Y31

One-line label for system identification, 40 × 80 mm

Resopal labels (white with black lettering) for identifying the control cabinets are available. The labels are stuck to the cabinet door.

Dimensions H × W: 40 × 80 mm (1.57 × 3.15 in)

The text must be specified in plain text when ordering.

Field 1: Max. 9 characters, font size 10 mm (0.39 in)

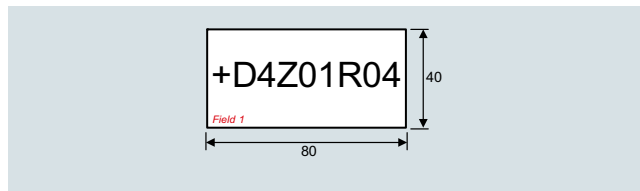

Y32

Two-line label for system identification, 40 × 180 mm

Resopal labels (white with black lettering) for identifying the control cabinets are available. The labels are stuck to the cabinet door.

Dimensions H × W: 40 × 180 mm (1.57 × 7.09 in)

The text must be specified in plain text when ordering.

Field 1: Max. 9 characters, font size 10 mm (0.39 in)

Field 2: Max. 9 characters, font size 10 mm (0.39 in)

Field 3: Max. 20 characters, font size 10 mm (0.39 in)

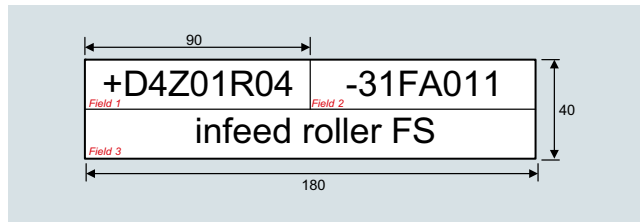

Y33

Four-line label for system identification, 40 × 180 mm

Resopal labels (white with black lettering) for identifying the control cabinets are available. The labels are stuck to the cabinet door.

Dimensions H × W: 40 × 180 mm (1.57 × 7.09 in)

The text must be specified in plain text when ordering.

Field 1: Max. 9 characters, font size 10 mm (0.39 in)

Field 2: Max. 20 characters, font size 6 mm (0.24 in)

Field 3: Max. 20 characters, font size 6 mm (0.24 in)

Field 4: Max. 20 characters, font size 6 mm (0.24 in)

Field 5: Max. 20 characters, font size 6 mm (0.24 in)

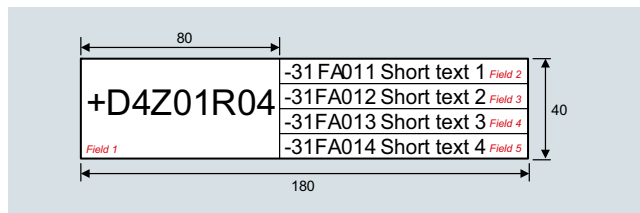

SINAMICS G120P Cabinet, converter cabinet units

SINAMICS G120P Cabinet, 75 kW to 630 kW

SINAMICS G120P Cabinet

Technical specifications

The most important directives and standards are listed below. These are used as basis for the SINAMICS G120P Cabinet converter cabinet units and they must be carefully observed to

achieve an EMC-compliant configuration that is safe both functionally and in operation.

European directives	
2014/35/EU	Low-voltage directive: Directive of the European Parliament and Council of February 26, 2014 for the harmonization of the laws of the member states relating to the provision of electrical equipment designed for use within certain voltage limits on the market (amended version)
2014/30/EU	EMC directive: Directive of the European Parliament and Council of February 26, 2014 for the harmonization of the laws of the member states relating to electromagnetic compatibility (amended version)
2006/42/EC	Machinery directive: The directive of the European Parliament and Council of May 17, 2006 on machinery and for changing Directive 95/16/EC (amendment)
European standards	
EN 60146-1-1	Semiconductor converters – General requirements and line-commutated converters Part 1-1: Specification of basic requirements
EN 60204-1	Electrical equipment of machines Part 1: General requirements
EN 60529	Degrees of protection provided by enclosures (IP code)
EN 61800-2	Adjustable speed electrical power drive systems Part 2: General requirements – Rating specifications for low-voltage adjustable frequency a.c. power drive systems
EN 61800-3	Adjustable speed electrical power drive systems Part 3: EMC product standard including specific test methods
EN 61800-5-1	Adjustable speed electrical power drive systems Part 5: Safety requirements Main section 1: Electrical and thermal requirements
General technical specifications	
Electrical specifications	
Line voltages and power ranges	380 ... 480 V 3 AC $\pm 10\%$, 75 ... 560 kW ¹⁾ 500 ... 690 V 3 AC $\pm 10\%$, 315 ... 630 kW
Line system configurations	Grounded TN/TT systems or ungrounded IT systems, a grounded line conductor is not permissible in 690 V line supplies
Line frequency	47 ... 63 Hz
Output frequency	0 ... 150 Hz
Offset factor $\cos \varphi$	0.96
Power factor λ	0.75 ... 0.93
Efficiency	>98 %
Overvoltage category	III according to EN 61800-5-1
Closed-loop control modes	Vector control without sensor or U/f control
Fixed speeds	15 fixed speeds plus 1 minimum speed, parameterizable (in the default setting, 3 fixed setpoints plus 1 minimum speed are selectable using terminal block/fieldbus system)
Skipped speed ranges	4, parameterizable
Setpoint resolution of the Control Unit	0.01 Hz 12 bit analog
Braking operation	DC braking, dynamic braking with optional Braking Module
Mechanical specifications	
Degree of protection	IP20 (higher degrees of protection up to IP54 optional)
Protection class	I according to EN 61800-5-1
Touch protection	According to EN 50274 and DGUV Regulation 3 when used for the intended purpose
Cabinet system	Industry-compatible control cabinet, doors with double-barb lock, base plate with cable entry options, crane transport aid
Paint finish	RAL 7035 (indoor requirements)
Type of cooling	Forced air cooling AF according to EN 60146

¹⁾ For the option **L01**, the line voltage is limited to 380 to 415 V AC $\pm 10\%$.

SINAMICS G120P Cabinet, converter cabinet units

SINAMICS G120P Cabinet, 75 kW to 630 kW

SINAMICS G120P Cabinet**Technical specifications** (continued)

General technical specifications			
Ambient conditions	Storage	Transport	Operation
Ambient temperature	-25 ... +55 °C (-13 ... 131 °F)	-25 ... +70 °C (-13 ... 158 °F) above <u>-40 °C</u> (-40 °F) for 24 hours	0 ... 40 °C (32 ... 104 °F) up to 50 °C (122 °F) see derating data
Relative humidity (condensation not permissible)	5 ... 95 % Class 1K4 acc. to EN 60721-3-1	<u>5</u> ... 95 % Class 2K3 acc. to EN 60721-3-2	5 ... 95 % Class 3K3 acc. to EN 60721-3-3
Environmental class/harmful chemical substances	Class 1C2 acc. to EN 60721-3-1	Class 2C2 acc. to EN 60721-3-2	Class 3C2 acc. to EN 60721-3-3
Organic/biological influences	Class 1B1 acc. to EN 60721-3-1	Class 2B1 acc. to EN 60721-3-2	Class 3B1 according to EN 60721-3-3 Restriction: No conductive dust particles permitted
Degree of pollution	2 according to EN 61800-5-1		
Installation altitude	Up to 1000 m (3281 ft) above sea level without derating > 1000 m (3281 ft) see derating data		
Mechanical strength	Storage	Transport ¹⁾	Operation
Vibratory load • Deflection • Acceleration	Class 1M2 acc. to EN 60721-3-1 1.5 mm at <u>5</u> ... 9 Hz 5 m/s ² at > 9 ... 200 Hz	Class 2M2 acc. to EN 60721-3-2 3.5 mm at 2 ... 9 Hz 10 m/s ² at > 9 ... 200 Hz	Class 3M2 acc. to EN 60721-3-3 0.075 mm at 10 ... 58 Hz 10 m/s ² at > 58 ... 200 Hz
Shock load • Acceleration	Class 1M2 acc. to EN 60721-3-1 40 m/s ² at 22 ms	Class 2M2 acc. to EN 60721-3-2 150 m/s ² at 11 ms	Class 3M2 acc. to EN 60721-3-3 50 m/s ² (<u>5 × g</u>)/30 ms <u>150 m/s² (15 × g)/11 ms</u>
Standards			
Compliance with standards	cULus, CE, RCM, EAC, KC, SEMI F47 ²⁾		
CE marking	According to EMC Directive 2014/30/EU, Low Voltage Directive 2014/35/EU, Machinery Directive 2006/42/EC		
Radio interference suppression	The SINAMICS G120P Cabinet converter systems are not designed for connection to the public power network ("first environment"). Radio interference suppression is compliant with the EMC product standard for variable-speed drives EN 61800-3 "Second environment" (industrial line supplies). The equipment can cause electromagnetic interference when it is connected to the public network. However, if supplementary measures are taken (e.g. line filter, see option L00) operation in the "first environment" is possible.		

Deviations from the specified classes are underlined.

¹⁾ In transport packaging.

²⁾ SEMI F47 for frame size HX (500 V to 690 V) and frame size JX available soon

SINAMICS G120P Cabinet, converter cabinet units

SINAMICS G120P Cabinet, 75 kW to 630 kW

SINAMICS G120P Cabinet

Technical specifications (continued)

Line voltage 380 ... 480 V 3 AC		SINAMICS G120P Cabinet converter cabinet units			
		6SL3710-1PE31-5AB0-Z	6SL3710-1PE31-8AB0-Z	6SL3710-1PE32-1AB0-Z	6SL3710-1PE32-5AB0-Z
Rated power					
• At I_L 400 V/50 Hz ¹⁾	kW	75	90	110	132
• At I_L 460 V/60 Hz ²⁾	hp	75	100	125	150
• At I_H 400 V/50 Hz ¹⁾	kW	55	75	90	110
• At I_H 460 V/60 Hz ²⁾	hp	60	75	100	125
Output current					
• Rated current I_{rated} (400 V \pm 10 %) ³⁾	A	145	178	205	250
• Rated current I_{rated} (480 V \pm 10 %) ³⁾	A	120	148	170	207
• Base-load current I_L (400 V \pm 10 %) ³⁾	A	145	178	205	250
• Base-load current I_L (480 V \pm 10 %) ³⁾	A	120	148	170	207
• Base-load current I_H (400 V \pm 10 %) ⁴⁾	A	110	145	178	205
• Base-load current I_H (480 V \pm 10 %) ⁴⁾	A	91	120	148	170
• Output current, max.	A	196	241	277	338
Input current					
• Rated current I_{rated} (400 V \pm 10 %) ⁵⁾	A	140	172	198	242
• Rated current I_{rated} (480 V \pm 10 %) ⁵⁾	A	117	143	165	202
• Base-load current I_L (400 V \pm 10 %) ³⁾	A	140	172	198	242
• Base-load current I_L (480 V \pm 10 %) ³⁾	A	117	143	165	202
• Base-load current I_H (400 V \pm 10 %) ⁴⁾	A	117	154	189	218
• Base-load current I_H (480 V \pm 10 %) ⁴⁾	A	97.5	128	157.5	182
• Input current, max.	A	189	232	267	327
Current requirement, 24 V DC auxiliary power supply ⁶⁾	A	1	1	1	1
Short-circuit current rating acc. to IEC in conjunction with the specified fuses without/with option L26	kA	65	65	65	65
Minimum short-circuit current ⁷⁾					
• For 3NE1 fuses	A	1800	2400	3000	3000
• For 3NA3 fuses	A	4400	5000	7000	7000
Power loss, max. at I_{rated} (400 V/40 °C), without options	kW	1.68	2.17	2.38	3.07
Coolant		Air	Air	Air	Air
Coolant requirements	m ³ /s (ft ³ /s)	0.16 (5.65)	0.16 (5.65)	0.16 (5.65)	0.16 (5.65)
Sound pressure level L_{pA}(1 m) at 50/60 Hz	dB	66/66	66/66	66/66	66/66
Cable length, max. ⁸⁾ between Power Module and motor					
• When compliant with Categories C2 and C3 according to EN 61800-3 shielded	m (ft)	150 (492)	150 (492)	150 (492)	150 (492)
• When non-compliant with the limit values for RI suppression and without output reactor unshielded	m (ft)	450 (1476)	450 (1476)	450 (1476)	450 (1476)
Dimensions					
• Width	mm (in)	400 (15.75)	400 (15.75)	400 (15.75)	400 (15.75)
• Height	mm (in)	2000 (78.74)	2000 (78.74)	2000 (78.74)	2000 (78.74)
• Depth	mm (in)	600 (23.62)	600 (23.62)	600 (23.62)	600 (23.62)
Frame size		F	F	F	F
Weight (degree of protection IP20, w/o options)	kg (lb)	165 (364)	165 (364)	165 (364)	165 (364)

Note:

The power data in hp units are based on the NEC/CEC standards for the North American market.

Information on the line connection, motor connection and cabinet grounding can be found in section [Cable cross-sections and connections](#).

- Rated power of a typ. 4-pole standard induction motor based on base-load current I_L or I_H at 400 V 3 AC/50 Hz
- Rated power of a typ. 4-pole standard induction motor based on base-load current I_L or I_H at 460 V 3 AC/60 Hz.
- The base-load current I_L is based on a duty cycle of 110 % for 60 s or 135 % for 3 s with a duty cycle duration of 300 s (see [overload capability characteristics](#)).
- The base-load current I_H is based on a duty cycle of 150 % for 60 s with a duty cycle duration of 300 s (see [overload capability characteristics](#)).

- The current values given here are based on the rated output current.
- If the drive closed-loop control is still to remain active when the main line supply fails, then the converter must be provided with an external 24 V DC supply.
- 10 ms value from current-time characteristic for reliable tripping of installed protection devices. If the minimum short-circuit current is not reached, the tripping time of the fuses is increased, which can lead to damage.
- Longer cable lengths are available on request.

SINAMICS G120P Cabinet, converter cabinet units

SINAMICS G120P Cabinet, 75 kW to 630 kW

SINAMICS G120P Cabinet

Technical specifications (continued)

Line voltage 380 ... 480 V 3 AC		SINAMICS G120P Cabinet converter cabinet units					
		6SL3710-1PE33-0.A0-Z	6SL3710-1PE33-7.A0-Z	6SL3710-1PE34-6.A0-Z	6SL3710-1PE35-8.A0-Z	6SL3710-1PE36-6.A0-Z	6SL3710-1PE37-4.A0-Z
Rated power							
• At I_L 400 V/50 Hz ¹⁾	kW	160	200	250	315	355	400
• At I_L 460 V/60 Hz ²⁾	hp	200	250	300	400	450	500
• At I_H 400 V/50 Hz ¹⁾	kW	132	160	200	250	250	315
• At I_H 460 V/60 Hz ²⁾	hp	150	200	200	300	300	350
Output current							
• Rated current I_{rated} (400 V \pm 10 %)	A	300	370	460	585	655	735
• Rated current I_{rated} (480 V \pm 10 %)	A	245	308	369	487	526	602
• Base-load current I_L (400 V \pm 10 %)	A	290	360	450	570	640	720
• Base-load current I_L (480 V \pm 10 %)	A	240	302	361	477	515	590
• Base-load current I_H (400 V \pm 10 %)	A	240	296	368	468	491	551
• Base-load current I_H (480 V \pm 10 %)	A	196	247	295	390	394	452
• Output current, max.	A	392	486	608	770	864	972
Input current							
• Rated current I_{rated} (400 V \pm 10 %)	A	317	375	469	597	668	750
• Rated current I_{rated} (480 V \pm 10 %)	A	262	314	376	497	536	614
• Base-load current I_L (400 V \pm 10 %)	A	307	365	459	585	654	735
• Base-load current I_L (480 V \pm 10 %)	A	257	308	368	486	525	602
• Base-load current I_H (400 V \pm 10 %)	A	254	300	375	477	501	562
• Base-load current I_H (480 V \pm 10 %)	A	210	251	301	397	402	461
• Input current, max.	A	415	493	620	785	881	992
Current requirement, 24 V DC auxiliary power supply ⁶⁾							
• Version A	A	1	1	1	1	1	1
• Version C	A	0.5	0.5	0.5	0.5	0.5	0.5
Short-circuit current rating acc. to IEC in conjunction with the specified fuses without/with option L26	kA	65/65	65/65	65/50	65/50	65/50	65/50
Minimum short-circuit current ⁷⁾							
• For 3NE1 fuses	A	3500	4500	7000	10000	11000	13000
• For 3NA3 fuses	A	9500	14000	20000	20000	30000	30000
Power loss, max. at I_{rated} (400 V/40 °C), without options	kW	4.01	4.871	5.683	7.358	8.287	9.101
Coolant		Air	Air	Air	Air	Air	Air
Coolant requirements	m ³ /s (ft ³ /s)	0.21 (7.42)	0.21 (7.42)	0.21 (7.42)	0.6 (21.2)	0.6 (21.2)	0.6 (21.2)
Sound pressure level L_{pA} (1 m) at 50/60 Hz							
• Version A	dB	66/66	66/66	66/66	69/69	69/69	69/69
• Version C	dB	63/63	63/63	63/63	66/66	66/66	66/66
Cable length, max. between Power Module and motor							
• When compliant with Categories C2 and C3 according to EN 61800-3 shielded	m (ft)	150 (492)	150 (492)	150 (492)	150 (492)	150 (492)	150 (492)
• When non-compliant with the limit values for RI suppression and without output reactor; unshielded	m (ft)	200 (656)	200 (656)	200 (656)	200 (656)	200 (656)	200 (656)
• When non-compliant with the limit values for RI suppression with output reactor; shielded/unshielded	m (ft)	300/450 (984/1476)	300/450 (984/1476)	300/450 (984/1476)	300/450 (984/1476)	300/450 (984/1476)	300/450 (984/1476)
Dimensions							
• Width for version A/C	mm (in)	1000/600 (39.37/23.62)	1000/600 (39.37/23.62)	1000/600 (39.37/23.62)	1200 ⁹⁾ /800 (47.24 ⁹⁾ /31.50)	1200 ⁹⁾ /800 (47.24 ⁹⁾ /31.50)	1200 ⁹⁾ /800 (47.24 ⁹⁾ /31.50)
• Height ⁸⁾	mm (in)	2000 (78.74)	2000 (78.74)	2000 (78.74)	2000 (78.74)	2000 (78.74)	2000 (78.74)
• Depth	mm (in)	600 (23.62)	600 (23.62)	600 (23.62)	600 (23.62)	600 (23.62)	600 (23.62)
Frame size		GX	GX	GX	HX	HX	HX
Weight Versions A/C (degree of protection IP20, without options)	kg (lb)	370/290 (816/639)	380/300 (838/661)	400/300 (882/661)	500/430 (1102/948)	500/440 (1102/970)	530/440 (1169/970)

Note:

The power data in hp units are based on the NEC/CEC standards for the North American market.

- Rated power of a typ. 4-pole standard induction motor based on base-load current I_L or I_H at 400 V 3 AC/50 Hz.
- Rated power of a typ. 4-pole standard induction motor based on base-load current I_L or I_H at 460 V 3 AC/60 Hz.
- The base-load current I_L is based on a duty cycle of 110 % for 60 s or 135 % for 3 s with a duty cycle duration of 300 s (see [overload capability characteristics](#)).
- The base-load current I_H is based on a duty cycle of 150 % for 60 s with a duty cycle duration of 300 s (see [overload capability characteristics](#)).

Information on the line connection, motor connection and cabinet grounding can be found in section [Cable cross-sections and connections](#).

- The current values given here are based on the rated output current.
- If the drive closed-loop control is still to remain active when the main line supply fails, then the converter must be provided with an external 24 V DC supply.
- 10 ms value from current-time characteristic for reliable tripping of installed protection devices. If the minimum short-circuit current is not reached, the tripping time of the fuses is increased, which can lead to damage.
- The cabinet height increases by 300 mm (11.81 in) for IP21 degree of protection, and by 400 mm (15.75 in) for IP23, IP43 and IP54 degrees of protection.
- The specified cabinet widths increase depending on the options selected. For details, see [description of option L01](#).

SINAMICS G120P Cabinet, converter cabinet units

SINAMICS G120P Cabinet, 75 kW to 630 kW

SINAMICS G120P Cabinet

Technical specifications (continued)

Line voltage 380 ... 480 V 3 AC		SINAMICS G120P Cabinet converter cabinet units		
		6SL3710-1PE38-4AA0-Z	6SL3710-1PE38-8AA0-Z	6SL3710-1PE41-0AA0-Z
Rated power				
• At I_L 400 V/50 Hz ¹⁾	kW	450	500	560
• At I_L 460 V/60 Hz ²⁾	hp	500	600	700
• At I_H 400 V/50 Hz ¹⁾	kW	355	400	450
• At I_H 460 V/60 Hz ²⁾	hp	450	500	500
Output current				
• Rated current I_{rated} (400 V \pm 10 %)	A	840	910	1021
• Rated current I_{rated} (480 V \pm 10 %)	A	677	739	847
• Base-load current I_L (400 V \pm 10 % ³⁾)	A	820	890	1000
• Base-load current I_L (480 V \pm 10 % ³⁾)	A	663	724	830
• Base-load current I_H (400 V \pm 10 % ⁴⁾)	A	672	728	786
• Base-load current I_H (480 V \pm 10 % ⁴⁾)	A	542	591	652
• Output current, max.	A	1107	1202	1350
Input current				
• Rated current I_{rated} (400 V \pm 10 % ⁵⁾)	A	870	945	1061
• Rated current I_{rated} (480 V \pm 10 % ⁵⁾)	A	702	767	880
• Base-load current I_L (400 V \pm 10 % ³⁾)	A	850	925	1039
• Base-load current I_L (480 V \pm 10 % ³⁾)	A	687	751	862
• Base-load current I_H (400 V \pm 10 % ⁴⁾)	A	696	756	816
• Base-load current I_H (480 V \pm 10 % ⁴⁾)	A	561	614	677
• Input current, max.	A	1147	1248	1402
Current requirement, 24 V DC auxiliary power supply ⁶⁾		A	1	1
Short-circuit current rating acc. to IEC in conjunction with the specified fuses without/with option L26		kA	65/65	65/65
Minimum short-circuit current ⁷⁾				
• For 3NE1 fuses	A	10400	14000	16000
• For 3NA3 fuses	A	40000	40000	52000
Power loss, max. at I_{rated} (400 V/40 °C), without options		kW	11.098	11.605
Coolant			Air	Air
Coolant requirements		m ³ /s (ft ³ /s)	0.7 (24.7)	0.7 (24.7)
Sound pressure level L_{pA}(1 m) at 50/60 Hz		dB	69/69	69/69
Cable length, max. between Power Module and motor				
• When compliant with Categories C2 and C3 according to EN 61800-3 shielded	m (ft)	150 (492)	150 (492)	150 (492)
• When non-compliant with the limit values for RI suppression and without output reactor; unshielded	m (ft)	200 (656)	200 (656)	200 (656)
• When non-compliant with the limit values for RI suppression with output reactor; shielded/unshielded	m (ft)	300/450 (984/1476)	300/450 (984/1476)	300/450 (984/1476)
Dimensions				
• Width	mm (in)	1200 (47.24) ⁹⁾	1200 (47.24) ⁹⁾	1200 (47.24) ⁹⁾
• Height ⁸⁾	mm (in)	2000 (78.74)	2000 (78.74)	2000 (78.74)
• Depth	mm (in)	600 (23.62)	600 (23.62)	600 (23.62)
Frame size			JX	JX
Weight (degree of protection IP20, w/o options)		kg (lb)	655 (1444)	676 (1490)

Note:

The power data in hp units are based on the NEC/CEC standards for the North American market.

Information on the line connection, motor connection and cabinet grounding can be found in section Cable cross-sections and connections.

¹⁾ Rated power of a typ. 4-pole standard induction motor based on base-load current I_L or I_H at 400 V 3 AC/50 Hz.

²⁾ Rated power of a typ. 4-pole standard induction motor based on base-load current I_L or I_H at 460 V 3 AC/60 Hz.

³⁾ The base-load current I_L is based on a duty cycle of 110 % for 60 s or 135 % for 3 s with a duty cycle duration of 300 s (see [overload capability characteristics](#)).

⁴⁾ The base-load current I_H is based on a duty cycle of 150 % for 60 s with a duty cycle duration of 300 s (see [overload capability characteristics](#)).

⁵⁾ The current values given here are based on the rated output current.

⁶⁾ If the drive closed-loop control is still to remain active when the main line supply fails, then the converter must be provided with an external 24 V DC supply.

⁷⁾ 10 ms value from current-time characteristic for reliable tripping of installed protection devices. If the minimum short-circuit current is not reached, the tripping time of the fuses is increased, which can lead to damage.

⁸⁾ The cabinet height increases by 300 mm (11.8 in) for degree of protection IP21, and by 400 mm (15.7 in) for degrees of protection IP23, IP43 and IP54.

⁹⁾ The specified cabinet widths increase depending on the options selected. For details, see [description of options L00 and L01](#).

SINAMICS G120P Cabinet, converter cabinet units

SINAMICS G120P Cabinet, 75 kW to 630 kW

SINAMICS G120P Cabinet

Technical specifications (continued)

Line voltage 500 ... 690 V 3 AC		SINAMICS G120P Cabinet converter cabinet units				
		6SL3710-1PG33-7 . A0-Z	6SL3710-1PG34-0 . A0-Z	6SL3710-1PG34-5 . A0-Z	6SL3710-1PG35-2 . A0-Z	
Rated power						
• At I_L 690 V/50 Hz ¹⁾	kW	315	355	400	450	
• At I_L 575 V/60 Hz ²⁾	hp	350	400	450	450	
• At I_H 690 V/50 Hz ¹⁾	kW	250	315	355	400	
• At I_H 575 V/60 Hz ²⁾	hp	250	300	350	450	
Output current						
• Rated current I_{rated} (500 V \pm 10 %)	A	368	400	453	516	
• Rated current I_{rated} (600 V \pm 10 %)	A	353	396	441	497	
• Rated current I_{rated} (690 V \pm 10 %)	A	340	393	430	480	
• Base-load current I_L (500 V \pm 10 %) ³⁾	A	361	392	443	505	
• Base-load current I_L (690 V \pm 10 %) ³⁾	A	330	385	420	470	
• Base-load current I_H (500 V \pm 10 %) ⁴⁾	A	295	320	367	423	
• Base-load current I_H (690 V \pm 10 %) ⁴⁾	A	272	314	348	394	
• Output current, max.	A	487	529	598	682	
Input current						
• Rated current I_{rated} (500 V \pm 10 %) ⁵⁾	A	383	416	471	537	
• Rated current I_{rated} (600 V \pm 10 %) ⁵⁾	A	367	412	459	517	
• Rated current I_{rated} (690 V \pm 10 %) ⁵⁾	A	354	409	447	499	
• Base-load current I_L (500 V \pm 10 %) ³⁾	A	375	408	461	526	
• Base-load current I_L (690 V \pm 10 %) ³⁾	A	343	401	437	489	
• Base-load current I_H (500 V \pm 10 %) ⁴⁾	A	307	333	381	440	
• Base-load current I_H (690 V \pm 10 %) ⁴⁾	A	283	327	362	410	
• Input current, max.	A	507	550	623	710	
Current requirement, 24 V DC auxiliary power supply ⁶⁾						
• Version A	A	1.0	1.0	1.0	1.0	
• Version C	A	0.5	0.5	0.5	0.5	
Short-circuit current rating acc. to IEC in conjunction with the specified fuses without/with option L26		kA	65/65	65/50	65/50	65/50
Minimum short-circuit current ⁷⁾						
• For 3NE1 fuses	A	3500	4500	7000	8500	
• For 3NA3 fuses	A	10000	10500	13000	14600	
Power loss, max. at I_{rated} (500 V/40 °C), without options		kW	5.838	6.665	7.429	8.259
Coolant			Air	Air	Air	Air
Coolant requirements		m ³ /s (ft ³ /s)	0.6 (21.2)	0.6 (21.2)	0.6 (21.2)	0.6 (21.2)
Sound pressure level L_{pA}(1 m) at 50/60 Hz						
• Version A/C	dB	69/69	69/69	69/69	69/69	
Cable length, max. between Power Module and motor						
• When compliant with Categories C2 and C3 according to EN 61800-3 shielded	m (ft)	150 (492)	150 (492)	150 (492)	150 (492)	
• When non-compliant with the limit values for RI suppression and without output reactor; unshielded	m (ft)	200 (656)	200 (656)	200 (656)	200 (656)	
• When non-compliant with the limit values for RI suppression with output reactor; shielded/unshielded	m (ft)	300/450 (984/1476)	300/450 (984/1476)	300/450 (984/1476)	300/450 (984/1476)	
Dimensions						
• Width for version A/C	mm (in)	1200 (47.24)	1200 (47.24)	1200 (47.24)	1200 (47.24)	
• Height ⁸⁾	mm (in)	2000 (78.74)	2000 (78.74)	2000 (78.74)	2000 (78.74)	
• Depth	mm (in)	600 (23.62)	600 (23.62)	600 (23.62)	600 (23.62)	
Frame size			HX	HX	HX	HX
Weight Versions A/C (degree of protection IP20, w/o options)		kg (lb)	515/435 (1135/959)	522/442 (1151/974)	522/442 (1151/974)	535/455 (1179/1003)

Note:

The power data in hp units are based on the NEC/CEC standards for the North American market.

- Rated power of a typ. 4-pole standard induction motor based on base-load current I_L or I_H at 690 V 3 AC/50 Hz.
- Rated power of a typ. 4-pole standard induction motor based on base-load current I_L or I_H at 575 V 3 AC/60 Hz.
- The base-load current I_L is based on a duty cycle of 110 % for 60 s or 135 % for 3 s with a duty cycle duration of 300 s (see [overload capability characteristics](#)).
- The base-load current I_H is based on a duty cycle of 150 % for 60 s with a duty cycle duration of 300 s (see [overload capability characteristics](#)).

Information on the line connection, motor connection and cabinet grounding can be found in section [Cable cross-sections and connections](#).

- The current values given here are based on the rated output current.
- If the drive closed-loop control is still to remain active when the main line supply fails, then the converter must be provided with an external 24 V DC supply.
- 10 ms value from current-time characteristic for reliable tripping of installed protection devices. If the minimum short-circuit current is not reached, the tripping time of the fuses is increased, which can lead to damage.
- The cabinet height increases by 300 mm (11.8 in) for degrees of protection IP20 and IP21, and by 400 mm (15.7 in) for degrees of protection IP23, IP43 and IP54.

SINAMICS G120P Cabinet, converter cabinet units

SINAMICS G120P Cabinet, 75 kW to 630 kW

SINAMICS G120P Cabinet

Technical specifications (continued)

Line voltage 500 ... 690 V 3 AC		SINAMICS G120P Cabinet converter cabinet units		
		6SL3710-1PG35-8AA0-Z	6SL3710-1PG36-5AA0-Z	6SL3710-1PG37-2AA0-Z
Rated power				
• At I_L 690 V/50 Hz ¹⁾	kW	500	560	630
• At I_L 575 V/60 Hz ²⁾	hp	500	600	700
• At I_H 690 V/50 Hz ¹⁾	kW	450	500	560
• At I_H 575 V/60 Hz ²⁾	hp	450	500	500
Output current				
• Rated current I_{rated} (500 V \pm 10 %) ³⁾	A	581	654	725
• Rated current I_{rated} (600 V \pm 10 %) ³⁾	A	557	623	693
• Rated current I_{rated} (690 V \pm 10 %) ³⁾	A	535	595	665
• Base-load current I_L (500 V \pm 10 %) ³⁾	A	569	640	710
• Base-load current I_L (690 V \pm 10 %) ³⁾	A	520	580	650
• Base-load current I_H (500 V \pm 10 %) ⁴⁾	A	482	523	580
• Base-load current I_H (690 V \pm 10 %) ⁴⁾	A	444	476	532
• Output current, max.	A	768	864	959
Input current				
• Rated current I_{rated} (500 V \pm 10 %) ⁵⁾	A	596	679	753
• Rated current I_{rated} (600 V \pm 10 %) ⁵⁾	A	578	647	720
• Rated current I_{rated} (690 V \pm 10 %) ⁵⁾	A	555	618	690
• Base-load current I_L (500 V \pm 10 %) ³⁾	A	591	665	737
• Base-load current I_L (690 V \pm 10 %) ³⁾	A	540	602	675
• Base-load current I_H (500 V \pm 10 %) ⁴⁾	A	501	543	602
• Base-load current I_H (690 V \pm 10 %) ⁴⁾	A	461	494	552
• Input current, max.	A	798	897	995
Current requirement, 24 V DC auxiliary power supply ⁶⁾	A	1	1	1
Short-circuit current rating acc. to IEC in conjunction with the specified fuses	kA	65	65	65
Minimum short-circuit current ⁷⁾				
• For 3NE1 fuses	A	10000	11000	13000
• For 3NA3 fuses	A	16000	20000	21000
Power loss, max. at I_{rated} (500 V/40 °C), without options	kW	8.688	9.468	10.688
Coolant		Air	Air	Air
Coolant requirements	m ³ /s (ft ³ /s)	0.7 (24.7)	0.7 (24.7)	0.7 (24.7)
Sound pressure level L_{pA} (1 m) at 50/60 Hz	dB	69/69	69/69	69/69
Cable length, max. between Power Module and motor				
• When compliant with Categories C2 and C3 according to EN 61800-3 shielded	m (ft)	150 (492)	150 (492)	150 (492)
• When non-compliant with the limit values for RI suppression and without output reactor; unshielded	m (ft)	200 (656)	200 (656)	200 (656)
• When non-compliant with the limit values for RI suppression with output reactor; shielded/unshielded	m (ft)	300/450 (984/1476)	300/450 (984/1476)	300/450 (984/1476)
Dimensions				
• Width	mm (in)	1200 (47.24) ⁹⁾	1200 (47.24) ⁹⁾	1200 (47.24) ⁹⁾
• Height ⁸⁾	mm (in)	2000 (78.74)	2000 (78.74)	2000 (78.74)
• Depth	mm (in)	600 (23.62)	600 (23.62)	600 (23.62)
Frame size		JX	JX	JX
Weight (degree of protection IP20, w/o options)	kg (lb)	654 (1442)	697 (1537)	716 (1579)

Note:

The power data in hp units are based on the NEC/CEC standards for the North American market.

Information on the line connection, motor connection and cabinet grounding can be found in section [Cable cross-sections and connections](#).

¹⁾ Rated power of a typ. 4-pole standard induction motor based on base-load current I_L or I_H at 690 V 3 AC/50 Hz.

²⁾ Rated power of a typ. 4-pole standard induction motor based on base-load current I_L or I_H at 575 V 3 AC/60 Hz.

³⁾ The base-load current I_L is based on a duty cycle of 110 % for 60 s or 135 % for 3 s with a duty cycle duration of 300 s (see [overload capability characteristics](#)).

⁴⁾ The base-load current I_H is based on a duty cycle of 150 % for 60 s with a duty cycle duration of 300 s (see [overload capability characteristics](#)).

⁵⁾ The current values given here are based on the rated output current.

⁶⁾ If the drive closed-loop control is still to remain active when the main line supply fails, then the converter must be provided with an external 24 V DC supply.

⁷⁾ 10 ms value from current-time characteristic for reliable tripping of installed protection devices. If the minimum short-circuit current is not reached, the tripping time of the fuses is increased, which can lead to damage.

⁸⁾ The cabinet height increases by 300 mm (11.8 in) for degree of protection IP21, and by 400 mm (15.7 in) for degrees of protection IP23, IP43 and IP54.

⁹⁾ The specified cabinet widths increase depending on the options selected. For details, see [description of option L00](#).

SINAMICS G120P Cabinet, converter cabinet units

SINAMICS G120P Cabinet, 75 kW to 630 kW

SINAMICS G120P Cabinet

Characteristic curves

Derating data

SINAMICS G120P Cabinet units and the associated system components are rated for an ambient temperature of 40 °C (104 °F) and installation altitudes up to 1000 m (3281 ft) above sea level.

At ambient temperatures of > 40 °C (104 °F), the output current must be reduced. Ambient temperatures above 50 °C (122 °F) are not permissible.

At installation altitudes > 1000 m (3281 ft) above sea level, it must be taken into account that the air pressure, and therefore air density, decreases as the height increases. As a consequence, the cooling efficiency and the insulation capacity of the air also decrease.

Due to the reduced cooling efficiency, it is necessary, on the one hand, to reduce the ambient temperature, and on the other hand, to lower heat loss in the converter cabinet unit by reducing the output current.

As additional measure for installation altitudes from 2000 m (6562 ft) up to 4000 m (13123 ft), an isolating transformer is required in order to reduce transient overvoltages according to EN 60664-1.

Automatic adjustment of pulse frequency for converter cabinet units from frame size GX onwards

In the factory setting, the drive starts with a pulse frequency of 4 kHz and reduces the pulse frequency automatically to the associated required frequencies when loaded. When the load decreases, the pulse frequency is increased automatically up to 4 kHz. The values of the rated current apply to a pulse frequency of 2 kHz and an ambient temperature of 40 °C (104 °F) and are reached at any time by the automatic adaptation of the output pulse frequency.

Current derating as a function of the installation altitude and the ambient temperature

At installation altitudes above 1000 m (3281 ft), the permissible output current can be compensated to a certain extent using the ambient temperature.

Current derating as a function of the installation altitude and the ambient temperature for SINAMICS G120P Cabinet frame size F, degrees of protection IP20 to IP54

Installation altitude above sea level m (ft)	Current derating factor (as a percentage of the base load current I_L) for an ambient/air intake temperature of						
	20 °C (68 °F)	25 °C (77 °F)	30 °C (86 °F)	35 °C (95 °F)	40 °C (104 °F)	45 °C (113 °F)	50 °C (122 °F)
0 ... 1000 (0 ... 3281)						93 %	85 %
1001 ... 1500 (3284 ... 4921)		100 %			95 %	88 %	81 %
1501 ... 2000 (4925 ... 6562)				97 %	90 %	83 %	
2001 ... 2500 (6565 ... 8202)			98 %	91 %	85 %		
2501 ... 3000 (8206 ... 9843)		98 %	92 %	86 %			
3001 ... 3500 (9846 ... 11483)	98 %	92 %	86 %				
3501 ... 4000 (11487 ... 13123)	92 %	86 %					

Note:

There is no derating to be considered up to 50 °C at high overload (HO) for SINAMICS G120P Cabinet units, frame size F. [see derating data at page 4/50](#)

Current derating as a function of the installation altitude and the ambient temperature for SINAMICS G120P Cabinet frame size GX, degrees of protection IP20 to IP54

Installation altitude above sea level m (ft)	Current derating factor (as a percentage of the rated output current) for an ambient/air intake temperature of						
	20 °C (68 °F)	25 °C (77 °F)	30 °C (86 °F)	35 °C (95 °F)	40 °C (104 °F)	45 °C (113 °F)	50 °C (122 °F)
0 ... 1000 (0 ... 3281)						93 %	85 %
1001 ... 1500 (3284 ... 4921)					96 %	89 %	81 %
1501 ... 2000 (4925 ... 6562)		100 %		99 %	92 %	85 %	
2001 ... 2500 (6565 ... 8202)				94 %	88 %		
2501 ... 3000 (8206 ... 9843)			96 %	90 %			
3001 ... 3500 (9846 ... 11483)		97 %	91 %				
3501 ... 4000 (11487 ... 13123)	98 %	92 %					

Current derating as a function of the installation altitude and the ambient temperature for SINAMICS G120P Cabinet frame sizes HX and JX, degrees of protection IP20 to IP54

Installation altitude above sea level m (ft)	Current derating factor (as a percentage of the rated output current) for an ambient/air intake temperature of						
	20 °C (68 °F)	25 °C (77 °F)	30 °C (86 °F)	35 °C (95 °F)	40 °C (104 °F)	45 °C (113 °F)	50 °C (122 °F)
0 ... 1000 (0 ... 3281)						93 %	85 %
1001 ... 1500 (3284 ... 4921)					97 %	89 %	82 %
1501 ... 2000 (4925 ... 6562)		100 %		97 %	93 %	86 %	
2001 ... 2500 (6565 ... 8202)				94 %	90 %		
2501 ... 3000 (8206 ... 9843)				90 %			
3001 ... 3500 (9846 ... 11483)			96 %				
3501 ... 4000 (11487 ... 13123)	98 %	92 %					

SINAMICS G120P Cabinet, converter cabinet units

SINAMICS G120P Cabinet, 75 kW to 630 kW

SINAMICS G120P Cabinet

Characteristic curves (continued)

Current derating as a function of the line voltage

The SINAMICS G120P Cabinet converter cabinet units supply a constant power over the full permissible range of line voltage.

The constant power results in current derating as a function of the line voltage.

SINAMICS G120P Cabinet	Rated power based on the base-load current I_L at 400 V kW	Rated output current in A at a line voltage of				
		380 V	400 V	415 V ¹⁾	460 V	480 V
6SL3710-1PE31-5AB0-Z	75	145	145	139.8	126.1	120.8
6SL3710-1PE31-8AB0-Z	90	178	178	171.6	154.8	148.3
6SL3710-1PE32-1AB0-Z	110	205	205	197.6	178.3	170.8
6SL3710-1PE32-5AB0-Z	132	250	250	241	217.4	207
6SL3710-1PE33-0 . A0-Z	160	300	300	290	259	245
6SL3710-1PE33-7 . A0-Z	200	370	370	358	325	308
6SL3710-1PE34-6 . A0-Z	250	460	460	443	393	369
6SL3710-1PE35-8 . A0-Z	315	585	585	567	513	487
6SL3710-1PE36-6 . A0-Z	355	655	655	631	559	526
6SL3710-1PE37-4 . A0-Z	400	735	735	710	636	602
6SL3710-1PE38-4AA0-Z	450	840	840	810	717	677
6SL3710-1PE38-8AA0-Z	500	910	910	877	791	739
6SL3710-1PE41-0AA0-Z	560	1021	1021	988	891	847

SINAMICS G120P Cabinet	Rated power based on the base-load current I_L at 690 V kW	Rated output current in A at a line voltage of				
		500 V	575 V	600 V	660 V	690 V
6SL3710-1PG33-7 . A0-Z	315	368	357	353	344	340
6SL3710-1PG34-0 . A0-Z	355	400	397	396	394	393
6SL3710-1PG34-5 . A0-Z	400	453	444	441	434	430
6SL3710-1PG35-2 . A0-Z	450	516	502	497	486	480
6SL3710-1PG35-8AA0-Z	500	581	563	554	542	535
6SL3710-1PG36-5AA0-Z	560	654	631	623	604	595
6SL3710-1PG37-2AA0-Z	630	725	701	693	674	665

¹⁾ Complete rated current up to 440 V, therefore no derating for 415 V ± 5%.

Operating ranges

An additional dimensioning aid is available for the converters. The purpose of this aid is to ensure the constant reliable operation of the converter, in particular with regard to service life expectancy.

The dimensioning aid clearly distinguishes between continuous operating ranges and short-time operating ranges. As a result, due consideration can be given to operating ranges when the plant is configured. For further details, please refer to the diagram below and the explanatory text.

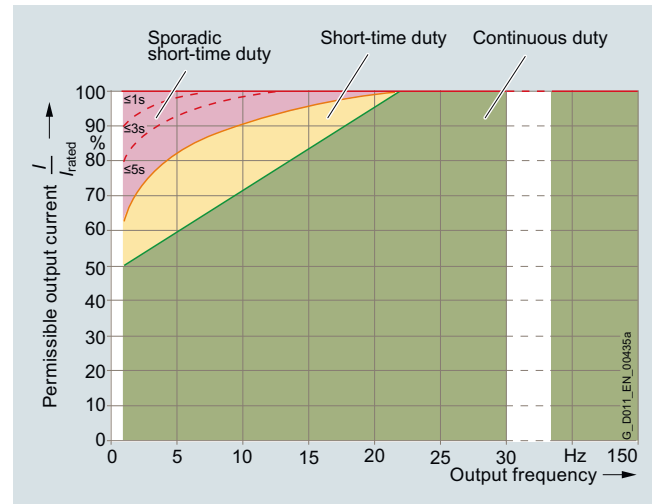

Operating ranges for SINAMICS G120P Cabinet

Continuous operation (green area) permissible.

Short-time operation (yellow area) permissible for 2 % of the total operating period without significant reduction in the converter service life; no overload reaction triggered by the thermal monitoring model.

Sporadic short-time operation (red area) permissible for only very short, rare operating states lasting less than 0.1 % of the total operating period without significant reduction in the converter service life; no overload reaction triggered by the thermal monitoring model on condition of compliance with the duty times specified in the diagram.

SINAMICS G120P Cabinet, converter cabinet units

SINAMICS G120P Cabinet, 75 kW to 630 kW

SINAMICS G120P Cabinet

Characteristic curves (continued)

Overload capability

SINAMICS G120P Cabinet converter cabinet units are equipped with an overload reserve to deal with breakaway torques, for example. If larger surge loads occur, this must be taken into account when configuring. In drives with overload requirements, the appropriate base-load current must, therefore, be used as a basis for the required load.

The unit can operate in two different duty cycles in the permissible continuous operating range shown in the diagram (green area). Depending on how the system is dimensioned, the relevant base-load current is effective as a rated quantity.

The criterion for overload is that the converter is operated with its base-load current before and after the overload occurs on the basis of a duty cycle duration of 300 s.

The base-load current for a low overload I_L is the basis for a duty cycle of 135 % for 3 s or 110 % for 60 s.

The base-load current I_H for a high overload is based on a duty cycle of 150 % for 60 s.

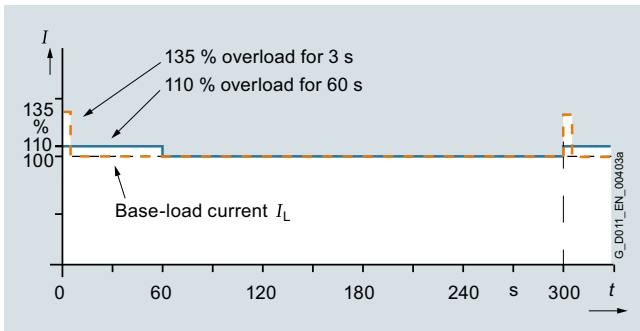

Overload capability, low overload for SINAMICS G120P Cabinet from 160 kW (215 hp)

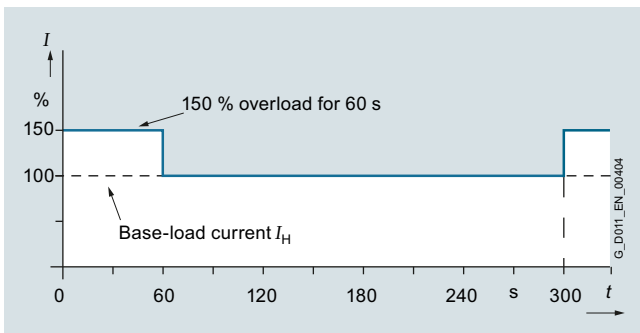

Overload capability, high overload

SINAMICS G120P Cabinet, converter cabinet units

SINAMICS G120P Cabinet, 75 kW to 630 kW

Recommended line-side overcurrent protection devices

Selection and ordering data

The fuses specified below are the recommended types for protecting the unit on the low-voltage distribution panel. If option **L26** (main switch) has been selected, the converter has integrated semiconductor protection. In this case, a fuse of type 3NA can be used on the low-voltage distribution panel.

Additional information on the fuses is provided in Catalog LV 10.

Rated power		SINAMICS G120P Cabinet converter	Fuse for option L26			Fuse (incl. semiconductor protection) without option L26		
At 400 V/690 V, 50 Hz kW	At 460 V/575 V, 60 Hz hp		Rated current A	Frame size acc. to IEC 60269-2	Article No.	Rated current A	Frame size acc. to IEC 60269-2	Article No.
380 ... 480 V 3 AC								
75	75	1PE31-5AB0-Z	200	1	3NA3140	200	1	3NE1225-0
90	100	1PE31-8AB0-Z	224	1	3NA3142	250	1	3NE1227-0
110	125	1PE32-1AB0-Z	300	2	3NA3250	315	1	3NE1230-0
132	150	1PE32-5AB0-Z	315	2	3NA3252	350	2	3NE1331-0
160	250	1PE33-0 . A0-Z	400	2	3NA3260	450	2	3NE1333-2
200	300	1PE33-7 . A0-Z	500	3	3NA3365	500	2	3NE1334-2
250	350	1PE34-6 . A0-Z	630	3	3NA3372	560	3	3NE1435-2
315	400	1PE35-8 . A0-Z	630	3	3NA3372	710	3	3NE1437-2
355	450	1PE36-6 . A0-Z	800	4	3NA3475	800	3	3NE1438-2
400	500	1PE37-4 . A0-Z	800	4	3NA3475	850	3	3NE1448-2
450	500	1PE38-4AA0-Z	1000	4	3NA3480	2 × 500	2	3NE1334-3^{*)}
500	600	1PE38-8AA0-Z	1000	4	3NA3480	2 × 560	3	3NE1435-3^{*)}
560	700	1PE41-0AA0-Z	1250	4	3NA3482	2 × 630	3	3NE1436-3^{*)}
500 ... 690 V 3 AC								
315	350	1PG33-7 . A0-Z	400	3	3NA3360-6	450	2	3NE1333-2
355	400	1PG34-0 . A0-Z	425	3	3NA3362-6	500	2	3NE1334-2
400	450	1PG34-5 . A0-Z	500	3	3NA3365-6	560	3	3NE1435-2
450	450	1PG35-2 . A0-Z	2 × 315	3	3NA3352-6^{*)}	630	3	3NE1436-2
500	500	1PG35-8AA0-Z	2 × 355	3	3NA3354-6^{*)}	710	3	3NE1437-2
560	600	1PG36-5AA0-Z	2 × 400	3	3NA3360-6^{*)}	800	3	3NE1438-2
630	700	1PG37-2AA0-Z	2 × 425	3	3NA3362-6^{*)}	850	3	3NE1448-2

Note:

The power data in hp units are based on the NEC/CEC standards for the North American market.

^{*)} 2 units.

SINAMICS G120P Cabinet, converter cabinet units

Notes

Tools and configuration

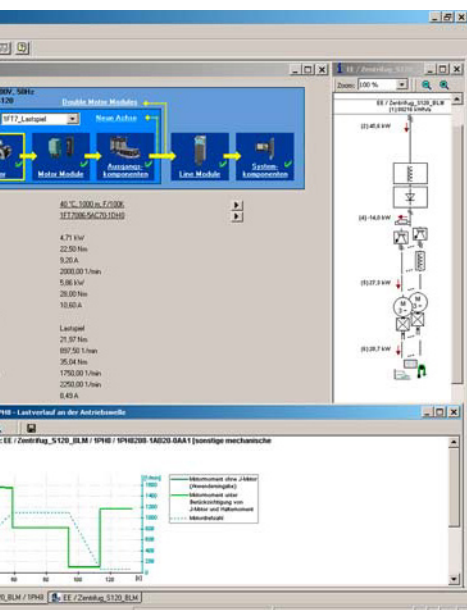
**Security information:**

Siemens provides products and solutions with industrial security functions that support the secure operation of plants, systems, machines and networks.

In order to protect plants, systems, machines and networks against cyber threats, it is necessary to implement – and continuously maintain – a holistic, state-of-the-art industrial security concept. Siemens' products and solutions constitute one element of such a concept.

Customers are responsible for preventing unauthorized access to their plants, systems, machines and networks. Such systems, machines and components should only be connected to an enterprise network or the internet if and to the extent such a connection is necessary and only when appropriate security measures (e.g. firewalls and/or network segmentation) are in place.

For additional information on industrial security measures that may be implemented, please visit

<https://www.siemens.com/industrialsecurity>

Siemens' products and solutions undergo continuous development to make them more secure. Siemens strongly recommends that product updates are applied as soon as they are available and that the latest product versions are used. Use of product versions that are no longer supported, and failure to apply latest updates may increase customer's exposure to cyber threats.

To stay informed about product updates, subscribe to the Siemens Industrial Security RSS Feed under

<https://www.siemens.com/industrialsecurity>

6/2	SinaSave energy efficiency tool
6/3	Drive Technology Configurator
6/4	SIZER for Siemens Drives engineering tool
6/5	SIZER WEB ENGINEERING engineering tool
6/6	STARTER commissioning tool
6/8	SINAMICS Startdrive commissioning tool
6/10	Drive ES engineering software
6/12	Configuration with EPLAN

**SINAMICS SELECTOR app
Mobile selection guide
for frequency inverters**



Siemens has developed the SINAMICS SELECTOR app as a practical tool for finding article numbers for your SINAMICS drives in the power range from 0.12 kW to 630 kW quickly and easily. Whether for SINAMICS V20, SINAMICS G120C, SINAMICS G120P or SINAMICS G120: the app will provide you with the correct article numbers conveniently.

How does it work? Simply select your application, the frequency inverters you require, the rated power and device options as well as the necessary accessories.

Then you can save your selection and send it by email. Your preselection serves as a basis for an order specification.

You will find the free downloads for Android and for iPhone/iPad at the following link:

www.siemens.com/sinamics-selector

Tools and configuration

SinaSave energy efficiency tool

Overview

The SinaSave energy efficiency tool calculates potential energy savings and amortization times based on your individual conditions of use and therefore offers practical assistance in making decisions about investments in energy-efficient technologies.

From SinaSave Version 6.0 and higher, the drive systems to be compared and the relevant drive component parameters are displayed graphically. An additional expansion are the numerous comparison possibilities for different control types and comprehensive product combinations for drive solutions for pump and fan applications. In addition to SIMOTICS motors and SINAMICS drives, the product portfolio comprises SIRIUS controls, offering a comprehensive range of comparison possibilities – according to your individual requirements.

SinaSave supports the evaluation of the various comparisons of product and system by

- Displaying the potential savings for energy and energy costs, as well as CO₂ emissions
- Estimation of the amortization time
- Estimation of the individual total lifecycle costs
- Representation of the system power losses according to EN 50598-2 for full load and partial load
- Direct comparison of Siemens drives with the reference Power Drive System (PDS) described in EN 50598-2

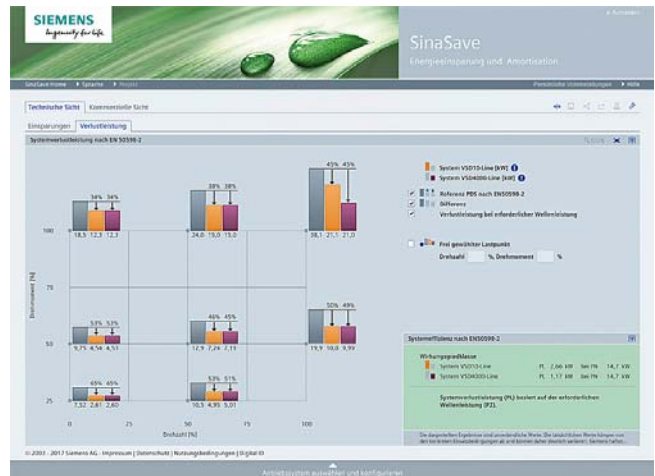

Access to the SinaSave energy efficiency tool

SinaSave can be accessed without the need for registration or logging in:
www.automation.siemens.com/sinasave

More information

For more information about the amortization calculator for energy-efficient drive systems, visit
www.siemens.com/sinasave

More information about services for energy saving is available on the Internet at
www.siemens.com/energysaving

SinaSave offers numerous comparison scenarios:

- Comparison of drive systems for pump and fan applications in the output range from 2.2 kW (low voltage) to 5.5 MW (medium voltage) for
 - Reactor control (fixed speed; motor and switching device)
 - Bypass control (fixed speed; motor and switching device)
 - Speed control (variable speed; motor and frequency converter)
- Comparison and evaluation of standard motors (incl. ignition protection motors) in different energy efficiency classes

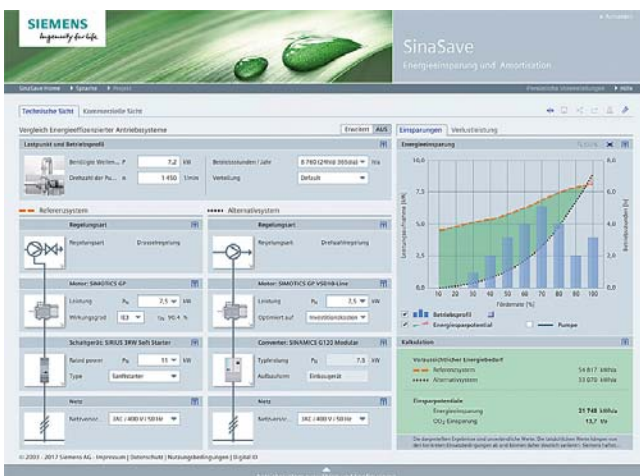

Overview

The Drive Technology (DT) Configurator helps you to configure the optimum drive technology products for your application – starting with gear units, motors, inverters as well as the associated options and components and ending with controllers, software licenses and connection systems. Whether with little or detailed knowledge of products: preselected product groups, deliberate navigation through selection menus and direct product selection through entry of the product number support quick, efficient and convenient configuration.

In addition, comprehensive documentation comprising technical data sheets, 2D dimensional drawings/3D CAD models, operating instructions, certificates, etc. can be selected in the DT Configurator. Immediate ordering is possible by simply transferring a parts list to the shopping cart of the Industry Mall.

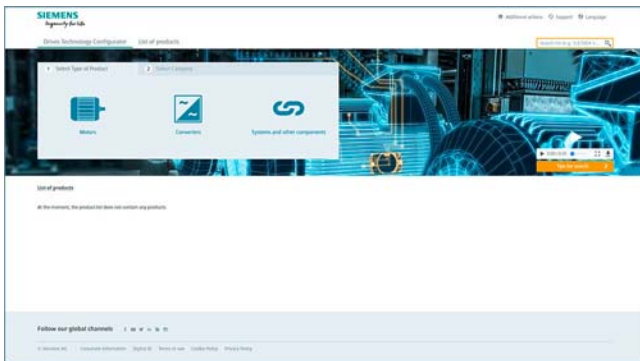

Drive Technology Configurator for efficient drive configuration with the following functions

- Quick and easy configuration of drive products and associated components – gear units, motors, inverters, controllers, connection systems
- Configuration of drive systems for pumps, fans and compressor applications from 1 kW to 2.6 MW
- Retrievable documentation for configured products and components, such as
 - Data sheets in up to 9 languages in PDF or RTF format
 - 2D dimensional drawings/3D CAD models in various formats
 - Terminal box drawing and terminal connection diagram
 - Operating instructions
 - Certificates
 - Start-up calculation for SIMOTICS motors
 - EPLAN macros
- Support with retrofitting in conjunction with Spares On Web www.siemens.com/sow
- Ability to order products directly through the Siemens Industry Mall

Access to the Drive Technology Configurator

The Drive Technology Configurator can be called up without registration and without a login:
www.siemens.com/dt-configurator

Selection and ordering data

Description	Article No.
Interactive catalog CA 01 on DVD-ROM including Drive Technology Configurator	
• German	E86060-D4001-A500-D8
• English	E86060-D4001-A510-D8-7600

More information

Online access to the Drive Technology Configurator

More information about the Drive Technology Configurator is available on the Internet at
www.siemens.com/dtconfigurator

Offline access to the Drive Technology Configurator in the Interactive Catalog CA 01

In addition, the Drive Technology Configurator is also included in the Interactive Catalog CA 01 on DVD-ROM – the offline version of the Siemens Industry Mall.

The Interactive Catalog CA 01 can be ordered from the relevant Siemens sales office or via the Internet:
www.siemens.com/automation/CA01

Tools and configuration

SIZER for Siemens Drives engineering tool

Overview

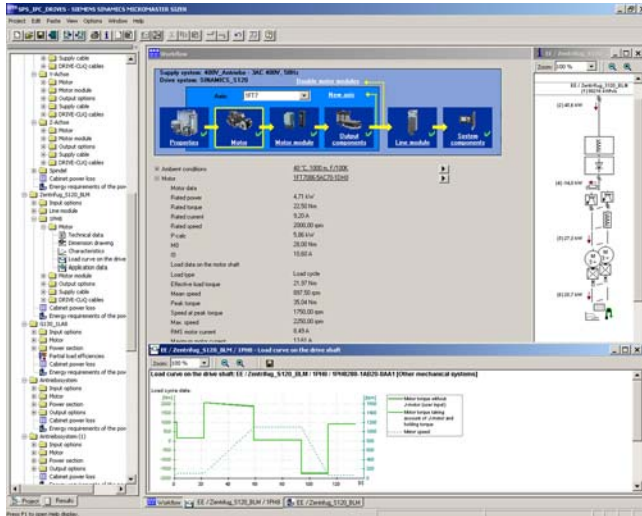

The following drives and controls can be engineered in a user-friendly way using the SIZER for Siemens Drives engineering tool:

- SIMOTICS low-voltage motors, including servo geared motors
- SINAMICS low-voltage drive systems
- Motor starters
- SINUMERIK CNC
- SIMOTION Motion Control controller
- SIMATIC controller

It provides support when selecting the technologies involved in the hardware and firmware components required for a drive task. SIZER for Siemens Drives covers the full range of operations required to configure a complete drive system, from basic single drives to complex multi-axis applications.

SIZER for Siemens Drives supports all of the engineering steps in one workflow:

- Configuring the power supply
- Designing the motor and gearbox, including calculation of mechanical transmission elements
- Configuring the drive components
- Compiling the required accessories
- Selecting the line-side and motor-side power options, e.g. cables, filters, and reactors

When SIZER for Siemens Drives was being designed, particular importance was placed on a high degree of usability and a universal, function-based approach to the drive application. The extensive user guidance makes it easy to use the tool. Status information keeps you continually informed about the progress of the configuration process.

The SIZER for Siemens Drives user interface is available in English, French, German and Italian.

The drive configuration is saved in a project. In the project, the components and functions used are displayed in a hierarchical tree structure.

The project view permits the configuration of drive systems and the copying/inserting/modifying of drives already configured.

The configuration process produces the following results:

- A parts list of the required components (export to Excel, use of the Excel data sheet for import to SAP)
- Technical specifications of the system
- Characteristic curves
- Comments on system reactions
- Mounting arrangement of drive and control components and dimensional drawings of motors
- Energy requirements of the configured application

These results are displayed in a results tree and can be reused for documentation purposes.

Support is provided by the technological online help menu:

- Detailed technical specifications
- Information about the drive systems and their components
- Decision-making criteria for the selection of components
- Online help in English, French, German, Italian, Chinese and Japanese

System requirements

- PG or PC with Pentium III min. 800 MHz (recommended > 1 GHz)
- 512 MB RAM (1 GB RAM recommended)
- At least 4.1 GB of free hard disk space
- An additional 100 MB of free hard disk space on Windows system drive
- Screen resolution 1024 × 768 pixels (1280 × 1024 pixels recommended)
- Operating system:
 - Windows 7 Professional (32/64-bit)
 - Windows 7 Enterprise (32/64-bit)
 - Windows 7 Ultimate (32/64-bit)
 - Windows 7 Home (32/64-bit)
 - Windows 8.1 Professional (32/64-bit)
 - Windows 8.1 Enterprise (32/64-bit)
- Microsoft Internet Explorer V5.5 SP2

Selection and ordering data

Description	Article No.
SIZER for Siemens Drives engineering tool on DVD-ROM	6SL3070-0AA00-0AG0
English, French, German, Italian	

More information

The SIZER for Siemens Drives engineering tool is available free on the Internet at www.siemens.com/sizer

Overview



The SIZER WEB ENGINEERING tool is used to engineer motors, converters/inverters and drive systems for a broad spectrum of applications within a wide power range starting below 1 kW up to 30 MW and above. To engineer a solution, you need to enter parameters for the motor, converter/inverter or the system – as well as parameters for your own specific application.

When the process is complete, you will receive comprehensive technical documentation (e.g. 3D models) including price information.

An inquiry function integrated in SIZER WEB ENGINEERING allows you to design special solutions for your drive task.

SIZER WEB ENGINEERING fully supports you from the inquiry stage, through the process of engineering products and drive systems, until your own individual quotation is ready. It supplies pricing information and then transfers the engineered products to your shopping cart in the Industry Mall. Seamless support during the engineering process enables you to save time and increase your productivity because you only need to enter the data once. You can use the entered data and the result as a basis for inquiries and orders.

SIZER WEB ENGINEERING is the platform for flexible engineering of your drive tasks and user-friendly management of your projects in conjunction with the engineering tools Drive Technology Configurator and SIZER for Siemens Drives.

Function

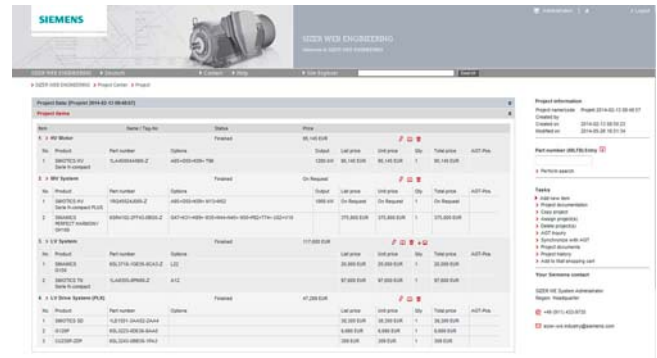

You can quickly find a solution for your drive task with the web-based tool: Menu-prompted workflows navigate you through the technical selection and dimensioning of products and drive systems, including the accessories. Based on an integrated inquiry functionality, SIZER WEB ENGINEERING also offers you special customized solutions for applications which cannot be addressed using "standard products", i.e. the focus is on flexibility and customized solutions.

Furthermore, you can engineer high-voltage motors, medium-voltage systems and rectifiers for your projects in addition to products from the low-voltage range. Integral tool functions also include comprehensive documentation such as data sheets, start-up calculations for low and high-voltage motors, 2D dimensional drawings and 3D CAD models, and offer documentation to name just a few.

Access to the SIZER WEB ENGINEERING engineering tool

SIZER WEB ENGINEERING is available after registration and approval:

www.siemens.com/sizer-we

More information

- More information on the SIZER WEB ENGINEERING engineering tool is available on the Internet at www.siemens.com/sizer-we
- Selection and Engineering Tools: www.siemens.com/engineering-tools

Tools and configuration

STARTER commissioning tool

Overview

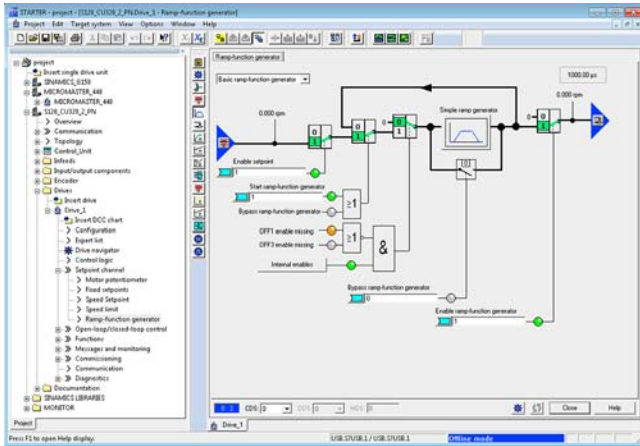

The user-friendly STARTER commissioning tool can be used for:

- Commissioning
- Optimization
- Diagnostics

This software can be operated as a standalone PC application, or integrated as a TIA-compatible program in SIMATIC STEP 7, or highly integrated into the SCOUT Engineering System (for SIMOTION). The basic functions and handling are the same in both cases.

In addition to the SINAMICS drives, STARTER also supports MICROMASTER 4 devices.

The project wizards can be used to create the drives within the structure of the project tree.

Beginners are supported by solution-based dialog guidance, whereby a standard graphics-based display maximizes clarity when setting the drive parameters.

First commissioning is guided by a wizard which makes all the basic settings in the drive. Therefore, getting a motor up and running is merely a question of setting a few of the drive parameters as part of the drive configuration process.

The individual settings required are made using graphics-based parameterization screens, which also precisely visualize the principle of operation of the drive.

Examples of individual settings that can be made include:

- How terminals are used
- Bus interface
- Setpoint channel (e.g., fixed setpoints)
- Closed-loop speed control (e.g., ramp-function generator, limits)
- BICO interconnections
- Diagnostics

For experts, the expert list can be used to specifically and quickly access individual parameters at any time. An individual compilation of frequently used parameters can be saved in dedicated user lists and watch tables.

In addition, the following functions are available for optimization purposes:

- Self-optimization of the controller settings (depending on drive unit)
- Setup and evaluation of trace recordings ¹⁾
Tool function for recording 2 × 8 signals with
 - Measuring cursor function
 - Extensive trigger functions
 - Several Y scales
 - Sampling times in the current controller cycle clock

Diagnostics functions provide information about:

- Control/status words
- Parameter status
- Operating conditions
- Communication states

Performance features

- User-friendly: Only a small number of settings need to be made for successful first commissioning: The motor starts to rotate
- Solution-oriented dialog-based user guidance simplifies commissioning
- Self-optimization functions reduce manual effort for optimization.

System requirements

The following minimum requirements must be complied with:

- Hardware
 - PG or PC with Pentium III min. 1 GHz (recommended >1 GHz)
 - Work memory 2 GB (4 GB recommended)
 - Screen resolution 1024 × 768 pixels, 16-bit color depth
 - Free hard disk memory: min. 5 GB
- Software
 - Microsoft Internet Explorer V6.0 or higher
 - 64-bit operating systems:
 - Microsoft Windows 7 Professional SP1
 - Microsoft Windows 7 Ultimate SP1
 - Microsoft Windows 7 Enterprise SP1 (standard installation)
 - Microsoft Windows Server 2008 R2 SP1
 - Microsoft Windows Server 2016
 - Microsoft Windows 10 Pro
 - Microsoft Windows 10 Enterprise

Supported virtualization platforms

STARTER (V5.1 SP1 and higher) can be installed on a virtual machine. For this purpose, one of the following virtualization platforms in the specified version or a newer version can be used:

- VMware vSphere Hypervisor (ESXi) 6.0
- VMware Workstation 11 V12.5.2
- VMware Player Pro 7.0 V12.5.2
- Microsoft Windows Server 2012 Hyper-V

You can use the following guest operating systems to install STARTER within the selected virtualization platform:

- Windows 7 Professional/Ultimate/Enterprise (64 bit)
- Windows 10 Professional/Enterprise (64 bit)

¹⁾ Depending on drive unit.
Not supported for MICROMASTER 4,
SINAMICS G110, SINAMICS G120 <firmware V4.4,
SINAMICS G110D and SINAMICS G120D <firmware V4.5.

Integration

Data can be exchanged (depending on the version) via PROFIBUS or PROFINET/Ethernet or via a serial interface.

For commissioning and service, a PG/PC can be connected to the CU320-2 Control Unit via PROFIBUS. A PROFIBUS connection must be available with a connecting cable at the PG/PC.

Further, communication between a CU320-2 Control Unit and PG/PC can also be established via Ethernet, either via an (optional) CBE20 Communication Board or the Ethernet interface -X127 on the CU320-2 Control Unit.

Note:

The terminal strip -X127 is suitable as a communication link to the PG/PC only for the purposes of servicing and commissioning.

Selection and ordering data

Description	Article No.
STARTER commissioning tool for SINAMICS and MICROMASTER English, French, German, Italian, Spanish	6SL3072-0AA00-0AG0

More information

The STARTER commissioning tool is also available on the Internet at

www.siemens.com/starter

Tools and configuration

SINAMICS Startdrive commissioning tool

Overview

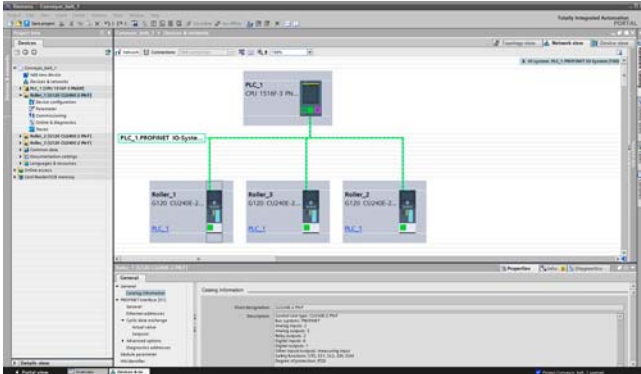

SINAMICS Startdrive is a tool for configuring, commissioning, and diagnosing the SINAMICS family of drives and is integrated into the TIA Portal.

SINAMICS Startdrive can be used to implement drive applications involving the following drives:

- SINAMICS G120
- SINAMICS G120C
- SINAMICS G120D
- SINAMICS G120P
- SINAMICS G110M

The SINAMICS Startdrive commissioning tool has been optimized with regard to user friendliness and consistent use of the TIA Portal benefits of a common working environment for PLC, HMI and drives.

Performance features

Efficient commissioning with easy configuration and powerful tools:

- High degree of usability thanks to task-based navigation through the engineering workflow
 - Hardware configuration
 - Parameterization
 - Commissioning
 - Diagnostics
- Time-saving and guided step-by-step commissioning
- User-friendly graphic function view for all drive functions
- List of drive parameters structured according to functions
- Easy integration of SIMOTICS motors
- Integrated control panel for direct operation of the drive from the TIA Portal
- Powerful realtime trace for commissioning and drive diagnostics
- Intuitive and efficient drive diagnostics through automatic display of messages
- Context-sensitive online help, e.g. for drive messages
- Integrated detailed drive diagnostic functions
 - Control/status words
 - Parameter status
 - Operating conditions
 - Communication states
- Simple configuration for drive-end Safety Integrated and the drive-internal basic positioning function (EPos)
- Graphic configuration of drive-internal free function blocks (FFB)

- Online work on the drive
 - Without previous creation of an offline project
 - With the new SINAMICS firmware without the need to perform a tool update.
- Available online functions without project: Commissioning with wizard and control panel, full parameter access with graphic function view and structured parameter list with complete drive diagnostics

Integration

Integration of SINAMICS drives with SIMATIC in the TIA Portal

The software packages based on the TIA Portal are harmonized with each other and offer important benefits. The TIA Portal enables simple integration of SINAMICS drives in your automation solution:

- Reduction in the familiarization overhead thanks to cross-tool uniformity of the operator inputs
- Device configuration and network connection of the drives in the TIA Portal-wide configuration/network editor
- Device access to the drives via the PLC across network boundaries (dataset routing)
- Automatic frame comparison between converters/inverters and SIMATIC S7 PLC
- Reduction of standstill times through the integration of converter/inverter messages in the SIMATIC S7 system diagnostics:
 - The drive messages are part of the SIMATIC S7 system diagnostics without previous configuration
 - The drive messages are therefore automatically available as plain text in the TIA Portal, the web server of the SIMATIC S7 PLC and the HMI
- Time savings thanks to simple and guided configuration of the drives for operation with SIMATIC S7 Motion Control
- Short familiarization time for SIMATIC STEP 7 users due to common use of editors. Realtime trace and the drive control panel are identical to the editors in STEP 7
- Reuse of the drive configuration and parameterization is possible with the assistance of the TIA Portal library
- Standard TIA Portal functions for converters/inverters, e.g. Undo, Redo
- Block library supplied for easy integration of SINAMICS drives into the user programs of the SIMATIC S7-300, S7-400, S7-1200, S7-1500
- Shared project storage for all devices in the project

Supported drives

Integration of the SINAMICS drives into the TIA Portal is carried out in steps. The following drives can be configured in SINAMICS Startdrive

- SINAMICS G120
- SINAMICS G120C
- SINAMICS G120D
- SINAMICS G120P
- SINAMICS G110M

All of the available Control Units from SINAMICS Firmware V4.4 are supported for these devices (including PROFINET, PROFIBUS, Safety Integrated). All combinable Power Modules up to 400 kW can be configured.

Installation versions

SINAMICS Startdrive can be installed as an optional package to SIMATIC STEP 7 or as a stand-alone application (without SIMATIC STEP 7).

Integration (continued)**Requirements for the installation**

The following chart shows the minimum hardware and software requirements that must be met for installation:

Hardware/software	Requirement
Processor	Intel Core i3-6100U, 2.3 GHz
RAM	4 GB
Hard disk	S-ATA with at least 8 GB available memory
Network	From 100 Mbit
Screen resolution	1024 × 768
Operating systems	<p>Windows 7 (64 bit)</p> <ul style="list-style-type: none"> Windows 7 Professional SP1 Windows 7 Enterprise SP1 Windows 7 Ultimate SP1 <p>Windows 8.1 (64 bit):</p> <ul style="list-style-type: none"> Windows 8.1 Professional Windows 8.1 Enterprise <p>Windows 10 (64 bit):</p> <ul style="list-style-type: none"> Windows 10 Professional Version 1607 Windows 10 Enterprise Version 1607 Windows 10 Enterprise 2016 LTSC Windows 10 Enterprise 2015 LTSC <p>Windows Server (64 bit)</p> <ul style="list-style-type: none"> Windows Server 2008 R2 StdE SP1 (full installation) Windows Server 2012 R2 StdE (full installation) Windows Server 2016 Standard (full installation)

Recommended PC hardware

The following table shows the recommended hardware for the operation of SINAMICS Startdrive.

Hardware	Recommendation
Computer	As of SIMATIC FIELD PG M5 Advanced (or comparable PC)
Processor	Intel Core i5-6440EQ (up to 3.4 GHz)
RAM	16 GB or more (32 GB for large projects)
Hard disk	SSD with at least 50 GB available space
Screen resolution	15.6 " Full HD display (1920 × 1080 or larger)

Compatibility with other products

- SINAMICS Startdrive can be installed alongside STARTER
- SINAMICS Startdrive V14 SP1 operates with STEP 7 Basic/Professional V14 SP1 and WinCC V14 SP1 in a framework
- SINAMICS Startdrive V14 SP1 can be installed on a computer alongside other versions of Startdrive, STEP 7, STEP 7 V5.4 or V5.5, STEP 7 Micro/WIN, WinCC flexible (2008 and above) and WinCC (V7.0 SP2 and above)

Supported virtualization platforms

SINAMICS Startdrive can be installed in a virtual machine. For this purpose, one of the following virtualization platforms in the specified version or a newer version can be used:

- VMware vSphere Hypervisor (ESXi) 6.0
- VMware Workstation 12.5
- VMware Player 12.5
- Microsoft Hyper-V Server 2016

The following operating systems can host these virtualization platforms:

- Windows 7 Professional/Ultimate/Enterprise (64 bit)
- Windows Server 2008 R2 (64 bit)
- Windows Server 2012 R2 (64 bit)
- Windows 8.1 Professional/Enterprise (64 bit)
- Windows 10 Professional/Enterprise (64 bit)

You can use the following guest operating systems to install SINAMICS Startdrive within the selected virtualization platform:

- Windows 7 Professional/Ultimate/ Enterprise (64 bit)
- Windows 8.1 Professional/Enterprise (64 bit)

Supported security programs

The following security programs are compatible with SINAMICS Startdrive V14 SP1:

- Virus scanners:
 - Symantec Endpoint Protection 12.1
 - Trend Micro Office Scan Corporate Edition 11.0
 - McAfee VirusScan Enterprise 8.8
 - Kaspersky Anti-Virus 2016
 - Windows Defender (Windows version 8.1 and above)
 - Qihoo "360 Safe Guard" 9.7
- Encryption software:
 - Microsoft Bitlocker
- Host-based Intrusion Detection System:
 - McAfee Application Control 6.2.0

Selection and ordering data

Description	Article No.
SINAMICS Startdrive commissioning tool incl. single license and Certificate of License English, French, German, Italian, Spanish, Chinese (simplified)	
<ul style="list-style-type: none"> On DVD-ROM 	
<ul style="list-style-type: none"> Software download/ online software delivery 	6SL3072-4EA02-0XA0 6SL3072-4EA02-0XG0

More information

The SINAMICS Startdrive commissioning tool is available free on the Internet at

www.siemens.com/startdrive

Tools and configuration

Drive ES engineering software

Overview

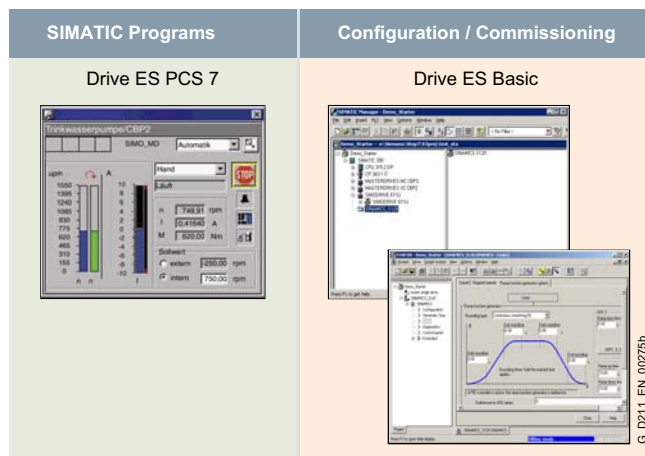

Drive ES is the engineering system used to integrate the communication, configuration and data management functions of Siemens drive technology into the SIMATIC automation world easily, efficiently and cost-effectively.

Various software packages are available for selection:

- Drive ES Basic Maintenance
- Drive ES PCS 7

Drive ES (**D**rive **E**ngineering **S**oftware) fully integrates drives from Siemens into the world of Totally Integrated Automation.

Design

Various software packages are available for selection:

- **Drive ES Basic Maintenance**
- **Drive ES PCS 7** (APL Style or Classic Style)

Drive ES Basic Maintenance

This software product will ensure TIA functionality for the previous drive systems not supported by STARTER.

Drive ES Basic Maintenance is for first-time users of the world of Totally Integrated Automation and the basic software for setting the parameters of all drives online and offline in this environment. Drive ES Basic Maintenance enables both the automation system and the drives to be handled using the SIMATIC Manager software. Drive ES Basic Maintenance is the starting point for common data archiving for complete projects and for extending the use of the SIMATIC teleservice to drives. Drive ES Basic Maintenance provides the configuration tools for the new Motion Control functions – slave-to-slave communication, equidistance and isochronous operation with PROFIBUS DP and ensures that drives with PROFINET IO are simply integrated into the SIMATIC environment.

Note:

For SINAMICS and MICROMASTER 4 drives, this TIA functionality is provided with the STARTER commissioning tool (V4.3.2 and higher).

Drive ES PCS 7 (APL Style or Classic Style)

Drive ES PCS 7 links the drives with a PROFIBUS DP interface into the SIMATIC PCS 7 process control system, and it requires that SIMATIC PCS 7, V6.1 and higher has first been installed. Drive ES PCS 7 provides a block library with the drives and the corresponding faceplates for the operator station, which enables the drives to be operated from the PCS 7 process control system. From V6.1 and higher, drives will also be able to be represented in the PCS 7 Maintenance Station.

From Drive ES PCS 7 V8.0 and higher, two versions of the library are available: The APL (Advanced Process Library) variant and the previous version in the so-called Classic Style.

Detailed contents of the Drive ES PCS 7 (APL Style or Classic Style)

- **Block library for SIMATIC PCS 7** Faceplates and control blocks for SIMOVERT MASTERDRIVES VC and MC, as well as MICROMASTER/MIDIMASTER of the third and fourth generation and SIMOREG DC MASTER and SINAMICS
- **STEP 7 slave object manager** for convenient configuration of drives and non-cyclic PROFIBUS DP communication with the drives
- **STEP 7 device object manager** for easy configuration of drives with PROFINET-IO interfaces (V8.0 SP1 and higher)
- **SETUP program** for installing the software in the PCS 7 environment

Selection and ordering data

Description	Article No.
Drive ES Basic Maintenance V5.6 SPx^{*)} Configuration software for the integration of drives into TIA (Totally Integrated Automation) Requirement: STEP 7 V5.4, SP4 or higher Type of delivery: on DVD-ROM Languages: de, en, fr, it, es with electronic documentation <ul style="list-style-type: none"> Floating licence, 1 user 	6SW1700-5JA00-6AA0
Drive ES PCS 7 V8.0 SPx^{*)} Block library for PCS 7 for the integration of drives in Classic Style (as predecessor) Requirement: PCS 7 V8.0 and higher Type of delivery: CD-ROM Languages: de, en, fr, it, es with electronic documentation <ul style="list-style-type: none"> Single-user license incl. 1 runtime license Runtime license (without data carrier) Update service for single-user license Upgrade from V6.x to V8.0 SPx^{*)} 	6SW1700-8JD00-0AA0 6SW1700-5JD00-1AC0 6SW1700-0JD00-0AB2 6SW1700-8JD00-0AA4
Drive ES PCS 7 APL V8.0 SPx^{*)} Block library for PCS 7 for the integration of drives in APL Style (Advanced Process Library) Requirement: PCS 7 V8.0 and higher Type of delivery: CD-ROM Languages: de, en, fr, it, es with electronic documentation <ul style="list-style-type: none"> Single-user license incl. 1 runtime license Runtime license (without data carrier) Update service for single-user license Upgrade of APL V8.0 to V8.0 SP1 or Drive ES PCS7 V6.x, V7.x, V8.x classic to Drive ES PCS7 APL V8.0 SPx^{*)} 	6SW1700-8JD01-0AA0 6SW1700-5JD00-1AC0 6SW1700-0JD01-0AB2 6SW1700-8JD01-0AA4
Drive ES PCS 7 V8.1 SPx^{*)} Block library for PCS 7 for the integration of drives in Classic Style (as predecessor) Requirement: PCS 7 V8.1 and higher Type of delivery: CD-ROM Languages: de, en, fr, it, es with electronic documentation <ul style="list-style-type: none"> Single-user license incl. 1 runtime license Runtime license (without data carrier) Update service for single-user license Upgrade from V6.x/V7.x/V8.x to V8.1 SPx^{*)} 	6SW1700-8JD00-1AA0 6SW1700-5JD00-1AC0 6SW1700-0JD00-0AB2 6SW1700-8JD00-1AA4
Drive ES PCS 7 APL V8.1 SPx^{*)} Block library for PCS 7 for the integration of drives in APL Style (Advanced Process Library) Requirement: PCS 7 V8.1 and higher Type of delivery: CD-ROM Languages: de, en, fr, it, es with electronic documentation <ul style="list-style-type: none"> Single-user license incl. 1 runtime license Runtime license (without data carrier) Update service for single-user license Upgrade of APL V8.x to V8.1 SPx^{*)} or Drive ES PCS 7 V6.x, V7.x, V8.x classic to Drive ES PCS 7 APL V8.1 SPx^{*)} 	6SW1700-8JD01-1AA0 6SW1700-5JD00-1AC0 6SW1700-0JD01-0AB2 6SW1700-8JD01-1AA4
Drive ES PCS 7 V8.2 SPx^{*)} Block library for PCS 7 for the integration of drives in Classic Style (as predecessor) Requirement: PCS 7 from V8.2 and higher Type of delivery: CD-ROM Languages: de, en, fr, it, es with electronic documentation <ul style="list-style-type: none"> Single-user license incl. 1 runtime license Runtime license (without data carrier) Update service for single-user license Upgrade from V6.x/V7.x/V8.x to V8.2 SPx^{*)} 	6SW1700-8JD00-2AA0 6SW1700-5JD00-1AC0 6SW1700-0JD00-0AB2 6SW1700-8JD00-2AA4

Description	Article No.
Drive ES PCS 7 APL V8.2 SPx^{*)} Block library for PCS 7 for the integration of drives in APL Style (Advanced Process Library) Requirement: PCS 7 from V8.2 and higher Type of delivery: CD-ROM Languages: de, en, fr, it, es with electronic documentation <ul style="list-style-type: none"> Single-user license incl. 1 runtime license Runtime license (without data carrier) Update service for single-user license Upgrade of APL V8.x to V8.2 SPx^{*)} or Drive ES PCS 7 V6.x, V7.x, V8.x classic to Drive ES PCS 7 APL V8.2 SPx^{*)} 	6SW1700-8JD01-2AA0 6SW1700-5JD00-1AC0 6SW1700-0JD01-0AB2 6SW1700-8JD01-2AA4
Drive ES PCS 7 V9.0 SPx^{*)} Block library for PCS 7 for the integration of drives in Classic Style (as predecessor) Requirement: PCS 7 V9.0 or higher Type of delivery: CD-ROM Languages: de, en, fr, it, es with electronic documentation <ul style="list-style-type: none"> Single-user license incl. 1 runtime license Runtime license (without data carrier) Update service for single-user license Upgrade from V6.x/V7.x/V8.x to V9.0 SPx^{*)} 	6SW1700-1JD00-0AA0 6SW1700-5JD00-1AC0 6SW1700-0JD00-0AB2 6SW1700-1JD00-0AA4
Drive ES PCS 7 APL V9.0 SPx^{*)} Block library for PCS 7 for the integration of drives in APL Style (Advanced Process Library) Requirement: PCS 7 V9.0 or higher Type of delivery: CD-ROM Languages: de, en, fr, it, es with electronic documentation <ul style="list-style-type: none"> Single-user license incl. 1 runtime license Runtime license (without data carrier) Update service for single-user license Upgrade of APL V8.x to V9.0 SPx^{*)} or Drive ES PCS 7 V6.x, V7.x, V8.x classic to Drive ES PCS 7 APL V9.0 SPx^{*)} 	6SW1700-1JD01-0AA0 6SW1700-5JD00-1AC0 6SW1700-0JD01-0AB2 6SW1700-1JD01-0AA4

Options

Drive ES software update service

A software update service can also be purchased for the Drive ES software. The user will automatically receive the latest software, service packs and full versions for one year after ordering.

The update service can only be ordered in addition to an existing (i.e. previously ordered) full version.

- Period of update service: 1 year

The update service is automatically extended by 1 further year unless canceled up to 6 weeks prior to expiration.

Description	Article No.
Drive ES PCS 7 <ul style="list-style-type: none"> Update service for single-user license 	6SW1700-0JD00-0AB2
Drive ES PCS 7 APL <ul style="list-style-type: none"> Update service for single-user license 	6SW1700-0JD01-0AB2

More information

More information is available on the Internet at www.siemens.com/drive-es

^{*)} Orders are automatically supplied with the latest Service Pack (SP).

Tools and configuration

Configuration with EPLAN

Overview

Configuring with EPLAN

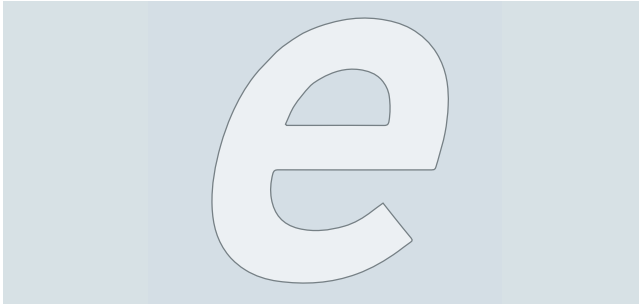

EPLAN is an engineering software for configuring electrical installations. The EPLAN platform combines expert systems for various disciplines, such as electrical, fluid and EMC engineering, as well as control cabinet and plant engineering. It provides the wiring information required to determine the optimal laying routes, connection lengths, bundle diameters, and design of the cable tree.

EPLAN Electric P8 – an EPLAN module – is CAE software specifically for configuring documentation and managing electrical automation projects for machines and systems. EPLAN Electric P8 offers the following functions:

- Creating circuit diagrams for control cabinets
- Managing article master data
- Automatic generation of bills of materials, terminal plans, PLC diagrams and overviews
- Preparation of the documentation for the configured system
- Design of the mechanical control cabinet configuration

EPLAN macros for SINAMICS components

EPLAN Electric P8 macros are available as downloads without charge, so that SINAMICS components can be easily and cost-effectively integrated into an EPLAN project. Macros are available for the following components:

- SINAMICS G120P, PM330 Power Modules
- SINAMICS G130 built-in units
- SINAMICS S120 chassis units
- SINAMICS DCM DC converters
- Line and motor-side components
- DC link components
- Control Units
- Supplementary system components

Using EPLAN Electric P8 macros substantially shortens the configuration time. All the necessary information about a component is supplied at the press of a button. This ensures that the data is up-to-date and correct – and mistakes/errors can be avoided.

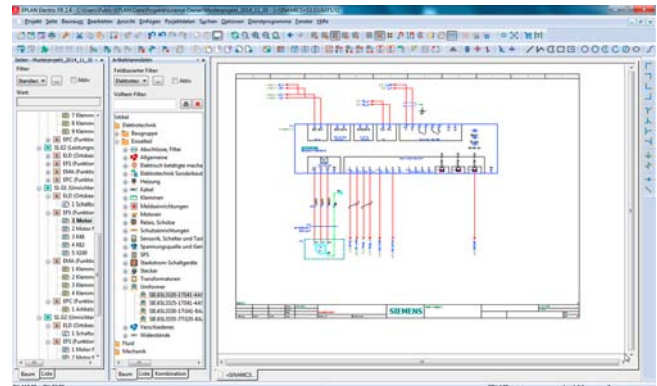

EPLAN user interface

The macros are provided in the file format EDZ (EPLAN Data Archived Zipped). An EDZ file is an archive for article master data, CAX data and macros. A macro in EDZ format contains the following data:

- Internal circuit diagrams
- Wiring diagrams
- Product master data
- Product images
- Data sheets

EPLAN Electric P8 macros for SINAMICS components are available in the following tools:

- Drive Technology Configurator (www.siemens.com/dt-configurator)
- CAX Onlinemanager
- Image database (download)

EPLAN projects for SINAMICS converter cabinet units

EPLAN projects are available for SINAMICS converter cabinet units, that simplify the configuration, and save time throughout the entire engineering process. EPLAN projects are available for the following converter cabinet units:

- SINAMICS G120P Cabinet
- SINAMICS G150
- SINAMICS G180
- SINAMICS S120 Cabinet Modules
- SINAMICS S150
- SINAMICS DCM Cabinet

The complete EPLAN project is supplied on a separate DVD-ROM together with the converter. The order is made by stating an additional Article No.

Overview (continued)

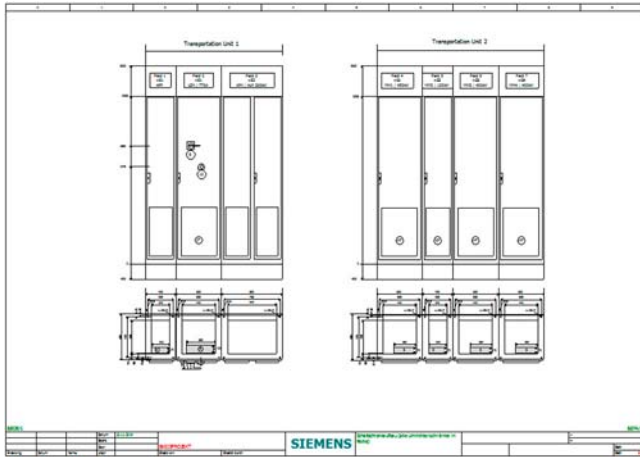

EPLAN project: Control cabinet layout

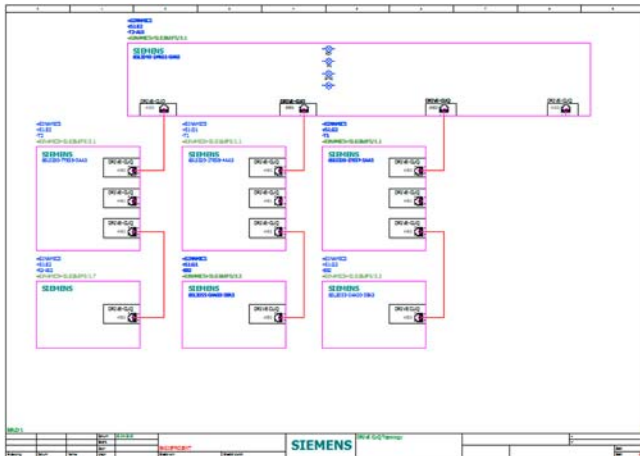

EPLAN project: DRIVE-CLiQ topology

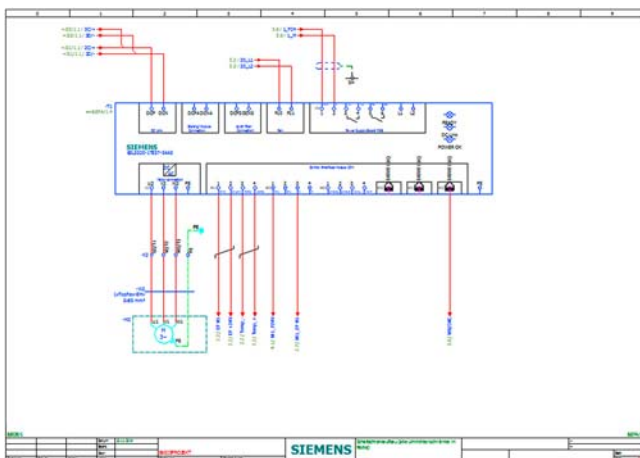

EPLAN project: Circuit diagram

The following data are available when you purchase the DVD-ROM:

- EPLAN project as a ZW1 file
- Updated, customer-specific, project article master database
- List of the article nos. created in the project
- A PDF version of the project

The EPLAN project includes the following documentation components:

- Title sheet
- Table of contents
- List of the structure identifiers used
- Single-line diagram
- General layout, external view
- General layout, internal view
- Circuit diagram
- Terminal diagram
- Connector diagram
- Parts list
- Order list/complete parts list

Selection and ordering data

Description	Article No.
EPLAN Electric P8	6SL3780-0AK00-0AA0
Project documentation on DVD-ROM for:	
<ul style="list-style-type: none"> • SINAMICS G120 P Cabinet • SINAMICS S120 Cabinet Modules • SINAMICS S150 • SINAMICS G150 	

Tools and configuration

Notes

Services and documentation



7/2	Partner, Industry Mall and Interactive Catalog CA 01
7/3	Information and Download Center
7/4	Industry Services
7/4	Unleash potential – with services from Siemens
7/4	Increase your performance – with Industry Services
7/5	<u>Industry Services – Portfolio overview</u>
7/5	Plant Data Services
7/5	Training Services
7/5	Support and Consulting Services
7/5	Spare Parts Services
7/5	Repair Services
7/5	Field and Maintenance Services
7/5	Retrofit and Modernization Services
7/5	Service Programs and Agreements
7/6	<u>Online Support</u>
7/6	Online Support App
7/7	Applications
7/8	Training
7/9	Training case
7/10	Control cabinets
7/12	Spares on Web
7/13	mySupport documentation
7/14	Documentation

Services and documentation

Partner · Industry Mall and Interactive Catalog CA 01

Partner at Siemens

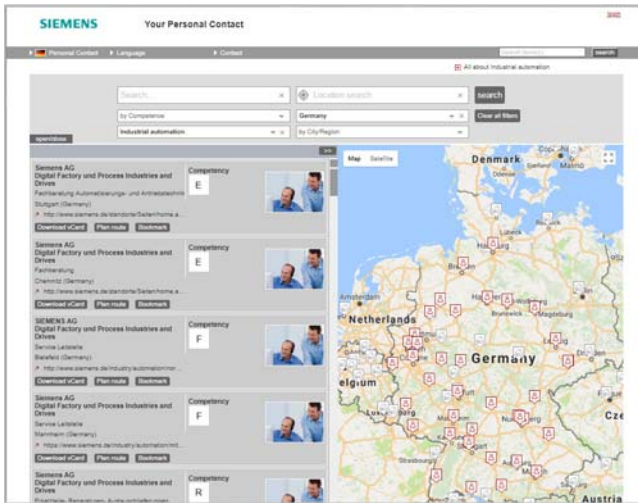

At your service locally, around the globe for consulting, sales, training, service, support, spare parts on the entire portfolio of Digital Factory and Process Industries and Drives.

Your partner can be found in our Personal Contacts Database at: www.siemens.com/automation-contact

You start by selecting

- the required competence,
 - products and branches,
 - a country and a city
- or by a
- location search or free text search.

Easy product selection and ordering in the Industry Mall and with the Interactive Catalog CA 01

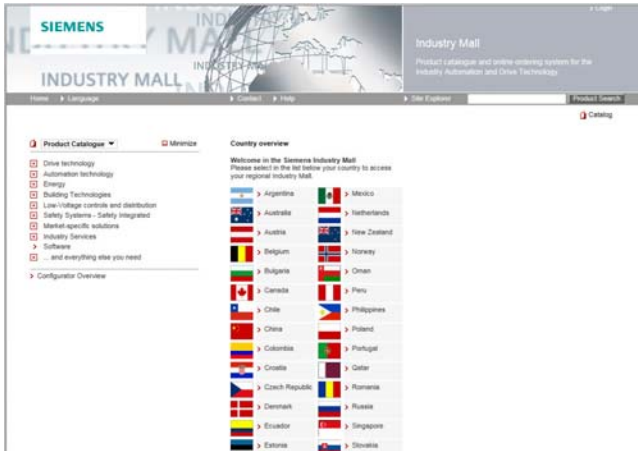

Industry Mall

The Industry Mall is a Siemens Internet ordering platform. Here you have a clear and informative online access to a huge range of products.

Powerful search functions make it easy to select the required products. Configurators enable you to configure complex product and system components quickly and easily. CAx data types are also provided here.

Data transfer allows the whole procedure, from selection through ordering to tracking and tracing, to be carried out online. Availability checks, customer-specific discounts and bid creation are also possible.

www.siemens.com/industrymall

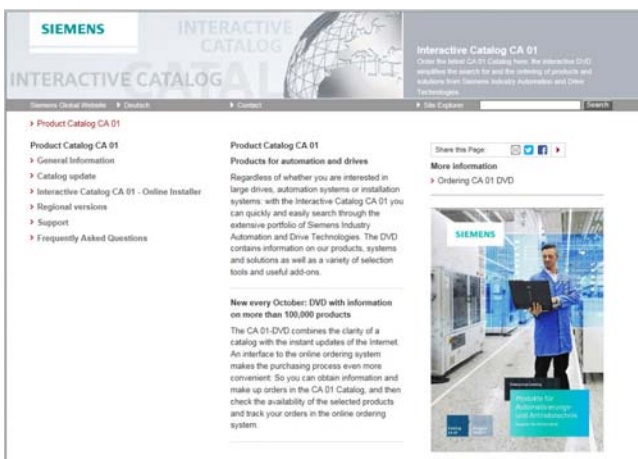

Interactive Catalog CA 01 - Products for Automation and Drives

The Interactive Catalog CA 01 combined with the Siemens Industry Mall unites the benefits of offline and online media in one application – the performance of an offline catalog with the availability of manifold and up-to-date information on the Internet.

Select products and assemble orders with the CA 01, determine the availability of the selected products and track & trace via the Industry Mall.

More information and download: www.siemens.com/automation/ca01

Downloading catalogs

The screenshot displays the Siemens Information and Download Center interface. At the top, there is a navigation bar with the Siemens logo and a search bar. Below the navigation bar, the main content area is titled "Information and Download Center". On the left side, there are tabs for "Catalogs (242)", "Brochures (118)", "Customer Magazines (8)", and "Demo Software (15)". A filter dialog is open, showing a search bar with the text "10" and a dropdown menu set to "English". Below the filter, there is a list of items, including "Catalog D 11 - 2016 (13 MB)" and "Catalog D 12 - 2017 with dimension drawings". Each item has a small thumbnail image and a "Download" button. On the right side, there is a sidebar with a "Text Size" selector, a "Share this Page" button, and a section titled "Products & Services" with a list of categories such as "Building Technologies (2)", "Drive technology (294)", "Energy (11)", "Industrial automation (822)", "Low-voltage controls and distribution (32)", "Safety systems - Safety integrated (31)", "Services (8)", and "Software (1)".

In the Information and Download Center you can download catalogs and brochures in PDF format without having to register. The filter dialog makes it possible to carry out targeted searches.

www.siemens.com/industry/infocenter

Services and documentation

Industry Services

Overview

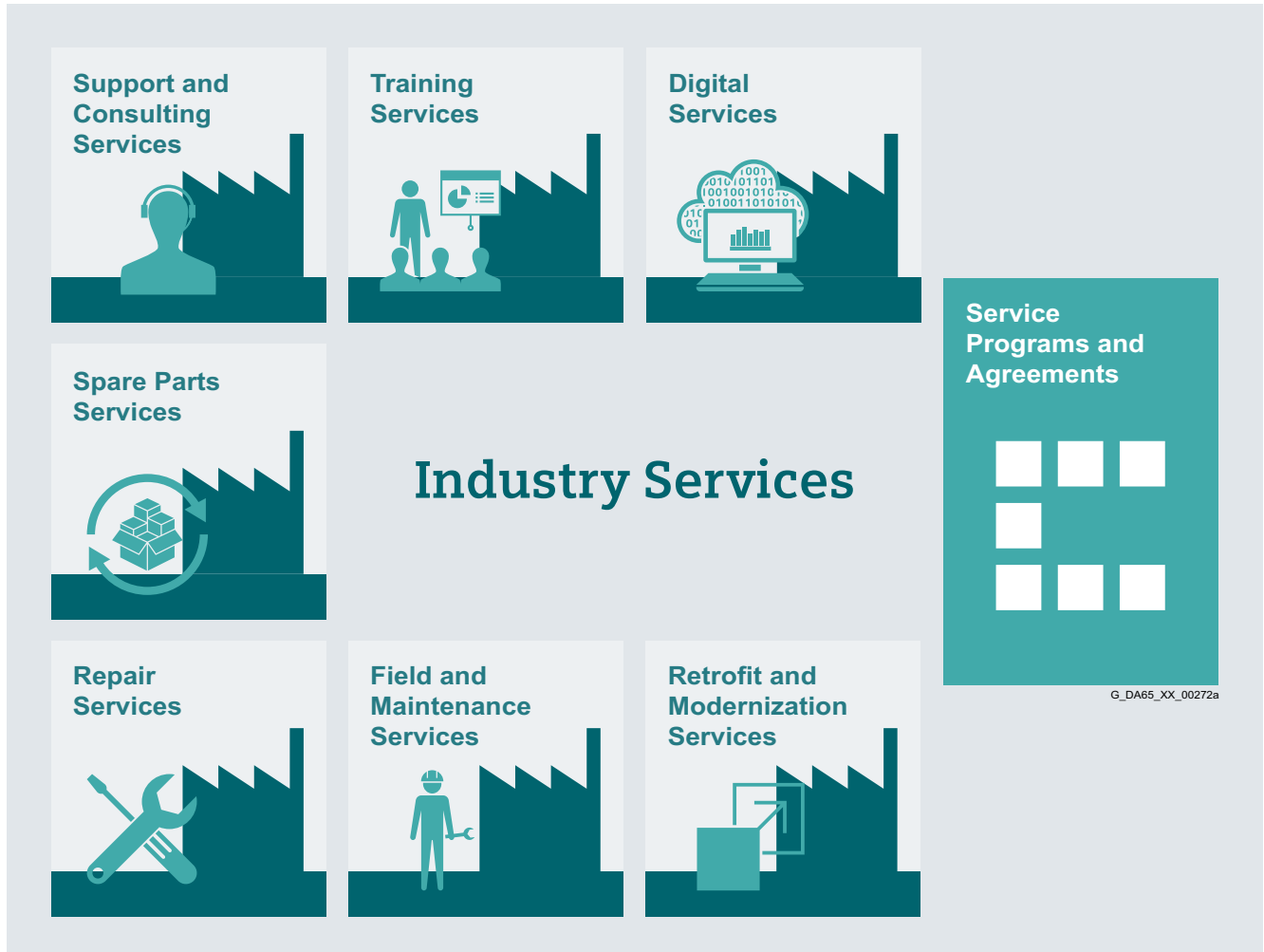

Keep your business running and shaping your digital future – with Industry Services

Optimizing the productivity of your equipment and operations can be a challenge, especially with constantly changing market conditions. Working with our service experts makes it easier. We understand your industry's unique processes and provide the services needed so that you can better achieve your business goals.

You can count on us to maximize your uptime and minimize your downtime, increasing your operations' productivity and reliability. When your operations have to be changed quickly to meet a new demand or business opportunity, our services give you the flexibility to adapt. Of course, we take care that your production is protected against cyber threats. We assist in keeping your operations as energy and resource efficient as possible and reducing your total cost of ownership. As a trendsetter, we ensure that you can capitalize on the opportunities of digitalization and by applying data analytics to enhance decision making: You can be sure that your plant reaches its full potential and retains this over the longer lifespan.

You can rely on our highly dedicated team of engineers, technicians and specialists to deliver the services you need – safely, professionally and in compliance with all regulations. We are there for you, where you need us, when you need us.

<https://www.siemens.com/global/en/home/products/services/industry.html>

Overview

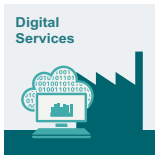

Digital Services

Digital Services make your industrial processes transparent to gain improvements in productivity, asset availability, and energy efficiency.

Production data is generated, filtered and translated with intelligent analytics to enhance decision-making.

This is done whilst taking data security into consideration and with continuous protection against cyber-attack threats.

<https://www.siemens.com/global/en/home/products/services/industry/digital-services.html>

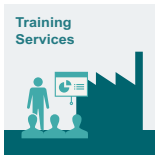

Training Services

From the basics and advanced to specialist skills, SITRAIN courses provide expertise right from the manufacturer – and encompass the entire spectrum of Siemens products and systems for the industry.

Worldwide, SITRAIN courses are available wherever you need a training course in more than 170 locations in over 60 countries.

<https://support.industry.siemens.com/cs/ww/en/sc/2226>



Support and Consulting Services

Industry Online Support site for comprehensive information, application examples, FAQs and support requests.

Technical and Engineering Support for advice and answers for all inquiries about functionality, handling, and fault clearance. The Service Card as prepaid support for value added services such as Priority Call Back or Extended Support offers the clear advantage of quick and easy purchasing.

Information & Consulting Services, e.g. SIMATIC System Audit; clarity about the state and service capability of your automation system or Lifecycle Information Services; transparency on the lifecycle of the products in your plants.

<https://support.industry.siemens.com/cs/ww/en/sc/2235>



Spare Parts

Spare Parts Services are available worldwide for smooth and fast supply of spare parts – and thus optimal plant availability. Genuine spare parts are available for up to ten years. Logistic experts take care of procurement, transport, custom clearance, storage and order manage-

ment. Reliable logistics processes ensure that components reach their destination as needed.

Since not all spare parts can be kept in stock at all times, Siemens offers a preventive measure for spare parts provisioning on the customer's premises with optimized **Spare Parts Packages** for individual products, custom-assembled drive components and entire integrated drive trains – including risk consulting.

Asset Optimization Services help you design a strategy for parts supply where your investment and carrying costs are reduced and the risk of obsolescence is avoided.

<https://support.industry.siemens.com/cs/ww/en/sc/2110>



Repair Services

Repair Services are offered on-site and in regional repair centers for fast restoration of faulty devices' functionality.

Also available are extended repair services, which include additional diagnostic and repair measures, as well as emergency services.

<https://support.industry.siemens.com/cs/ww/en/sc/2154>



Field and Maintenance Services

Siemens specialists are available globally to provide expert field and maintenance services, including commissioning, functional testing, preventive maintenance and fault clearance.

All services can be included in customized service agreements with defined reaction times or fixed maintenance intervals.

<https://support.industry.siemens.com/cs/ww/en/sc/2265>



Retrofit and Modernization Services

Provide a cost-effective solution for the expansion of entire plants, optimization of systems or upgrading existing products to the latest technology and software, e.g. migration services for automation systems.

Service experts support projects from planning through commissioning and, if desired over the entire extended lifespan, e.g. Retrofit for Integrated Drive Systems for an extended lifetime of your machines and plants.

<https://support.industry.siemens.com/cs/ww/en/sc/2286>



Service Programs and Agreements

A technical Service Program or Agreement enables you to easily bundle a wide range of services into a single annual or multi-year agreement.

You pick the services you need to match your unique requirements or fill gaps in your organization's maintenance capabilities.

Programs and agreements can be customized as KPI-based and/or performance-based contracts.

<https://support.industry.siemens.com/cs/ww/en/sc/2275>

Services and documentation

Industry Services

Online Support

Overview

Online Support – fast, intuitive, whenever you want, wherever you need

Web

support.industry.siemens.com

App

GET IT ON Google Play | GET IT ON App Store | Microsoft

Scan the QR code for information on our Online Support app.

- FAQ / Application examples**
Information about industrial products, programming and configuration as well as application examples
- Technical Information**
Videos, documentation, manuals, updates, product notes, compatibility tool, certificates, planning data such as dimensional drawings, product data, 3D models
- Forum**
Exchange information and experience with other users and experts

Online Support for Siemens Products for Industry

Siemens Industry and Online Support with some 1.7 million visitors per month is one of the most popular web services provided by Siemens. It is the central access point for comprehensive technical know-how about products, systems and services for automation and drives applications as well as for process industries.

In connection with the challenges and opportunities related to digitalization you can look forward to continued support with innovative offerings.

Overview



Our understanding of an application is the customer-specific solution of an automation task based on standard hardware and software components. In this respect, industry knowledge and technological expertise are just as important as expert knowledge about how our products and systems work. We are setting ourselves this challenge with more than 280 application engineers in 19 countries.

Application centers

We currently have application centers in:

- Germany: Head Office in Erlangen and in other German regions, e.g. in Munich, Nuremberg, Stuttgart, Mannheim, Frankfurt, Chemnitz, Cologne, Bielefeld, Bremen, Hanover, Hamburg
- Belgium: Brussels
- Brazil: Sao Paulo
- China: Beijing and 12 regions
- Denmark: Ballerup
- France: Paris
- Great Britain: Manchester
- India: Mumbai
- Italy: Bologna, Milan
- Japan: Tokyo, Osaka
- The Netherlands: The Hague
- Austria: Vienna
- Poland: Warsaw
- Sweden: Göteborg
- Switzerland: Zurich, Lausanne
- Spain: Madrid
- South Korea: Seoul
- Taiwan: Taipei
- Turkey: Istanbul
- USA: Atlanta

These application centers specialize in the use of SIMATIC/SIMOTION/SINAMICS. You therefore can rely on automation and drive specialists for implementing successful applications. By involving your personnel at an early stage in the process, we can provide a solid basis for rapid knowledge transfer, maintenance and further development of your automation solution.

Advice on applications and implementation

We offer a variety of consultation services to help you find the optimum solution for the SIMATIC/SIMOTION/SINAMICS application you want to implement:

The quotation phase includes

- clarification of technical questions,
- discussion of machine concepts and customer-specific solutions,
- selection of suitable technology and
- suggestions for implementation.

A technical feasibility study is also performed at the outset. In this way, difficult points of the application can be identified and solved early on. We can also configure and implement your application as a complete solution from a single source.

A large number of proven standard applications are available for use during the implementation phase. This saves engineering costs.

The system can be commissioned by experienced, competent personnel, if required. This saves time and trouble.

If servicing is required, we can support you on site or remotely. For more information about servicing, please see the section "Industry Services".

On-site application training

Training for the implemented applications can also be organized and carried out on site. This training for machine manufacturers and their customers does not deal with individual products, but the entire hardware and software system (for example, automation, drives and visualization).

From an initial concept to successful installation and commissioning: We can provide complete support for SIMATIC/SIMOTION/SINAMICS! Contact your Siemens representative.

You can find more information at www.siemens.com/machinebuilding

Services and documentation

Training



Your benefit from practical training directly from the manufacturer

SITRAIN – Training for Industry – provides you with comprehensive support in solving your tasks.

Training directly from the manufacturer enables you to make correct decisions with confidence.

Increased profits and lower costs:

- Shorter times for commissioning, maintenance and servicing
- Optimized production operations
- Reliable configuration and startup
- Shorten commissioning times, reduce downtimes, and faster troubleshooting
- Exclude expensive faulty planning right from the start.
- Flexible plant adaptation to market requirements
- Compliance with quality standards in production
- Increased employee satisfaction and motivation
- Shorter familiarization times following changes in technology and staff

Contact

Visit our site on the Internet at:
www.siemens.com/sitrain

or let us advise you personally. You can request our latest training catalog from:

SITRAIN – Training for Industry
SITRAIN Customer Support Germany:

Tel.: +49 911 895-7575

Fax: +49 911 895-7576

Email: info@sitrain.com

Your benefits with SITRAIN – Training for Industry

Certified top trainers

Our trainers are skilled specialists with practical experience. Course developers have close contact with product development, and pass on their knowledge to the trainers and then to you.

Practical application with practice

Practice, practice, practice! We have designed the trainings with an emphasis on practical exercises. They take up to half of the course time in our trainings. You can therefore implement your new knowledge in practice even faster.

300 courses in more than 60 countries

We offer a total of about 300 classroom-based courses. You can find us at more than 50 locations in Germany, and in 62 countries worldwide. You can find which course is offered at which location at:

www.siemens.com/sitrain

Skills development

Do you want to develop skills and fill in gaps in your knowledge? Our solution: We will provide a program tailored exactly to your personal requirements. After an individual requirements analysis, we will train you in our training centers near you or directly at your offices. You will practice on the most modern training equipment with special exercise units. The individual training courses are optimally matched to each other and help with the continuous development of knowledge and skills. After finishing a training module, the follow-up measures make success certain, as well as the refreshment and deepening of the knowledge gained.

Overview



The SINAMICS G120P training case in compact design was developed for demonstration at the customer's premises and for training purposes. Using this case, the functions of the drive can be presented easily and in a structured manner.

It contains the following components:

- SINAMICS G120P
 - PM230 Power Module, IP20 version, 0.55 kW
 - CU230P-2 HVAC Control Unit
 - Operator panel BOP-2
- SIMOTICS GP induction motor

The SINAMICS G120P training case is supplied in the form of a stackable Tanos System case of size 4.

Technical specifications

SINAMICS G120P training case	6AG1067-2AA00-0AA1
Supply voltage	230 V 1 AC
Dimensions	
• Width	240 mm (9.45 in)
• Height	300 mm (11.81 in)
• Depth	280 mm (11.02 in)
Weight, approx.	8 kg (17.64 lb)

Selection and ordering data

Description	Article No.
SINAMICS G120P training case	6AG1067-2AA00-0AA1

Services and documentation

Control cabinets

Overview

Complete equipment for machine tools and production systems

Our supplied range of products and services also includes complete equipment for machine tools and production systems with all services in the process chain from consulting through to after-sales service.

We support you in the areas of engineering, production and logistics.

Engineering support

Siemens supports you with advice on design in accordance with standards and concepts for drive systems, control, operation and safety.

Our engineers configure for you in EPLAN P8 and other commonly used CAD systems, execute projects designed to cost and adapt your documents where necessary to UL or new systems.

Our Technical Competence Center Cabinets in Chemnitz supports you with selecting and optimizing the suitable control-cabinet air-conditioning system. Apart from calculation and simulation, we also use instrumentation testing in our heat laboratory with load simulation.

We also offer the following services:

- Vibration measurements and control cabinet certification in the field
- Measurement of conducted interference voltages in our laboratory



Cabinet engineering

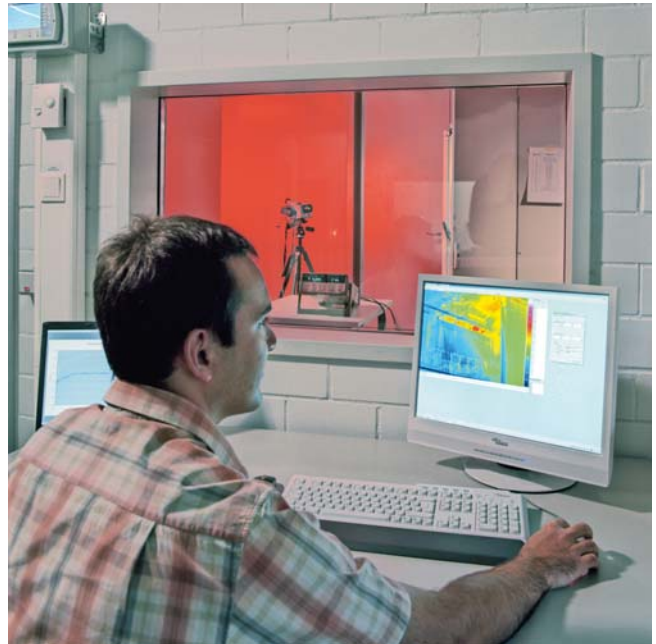

Testing in the heat laboratory

Production at a high level of quality

Complete equipment is manufactured at a high industrial level. This means:

- Examining consistency of the job documentation
- Checking for adherence to current regulations
- Collision check in 3D layout, taking into account the free space required thermally and electrically
- Automatic preparation of enclosures, cables and cable bundles
- Automated inspection and shipment free of faults
- Documentation and traceability
- Declaration of conformity regarding the Low-Voltage Directive and manufacturer's declaration on machinery directive
- UL label on request

Superior logistics

Everything from a single source offers you the following advantages:

- Cost savings for procurement, stockkeeping, financing
- Reduction in throughput times
- Just-in-time delivery

Overview (continued)***Individual support and maximum flexibility***

Our technical consultants for complete equipment support customers and sales departments in the various regions. Our control cabinet customers are supported in the Systems Engineering Plant Chemnitz (WKC) by ordering centers and production teams that are permanently assigned to customers.

Distance does not present a problem; we also use web cams for consulting our customers.



Worldwide repair service

Customer-specific logistics models, flexible production capacity and production areas as well as change management in all process phases ensure maximum flexibility.

Customized supplementary products

As part of its complete equipment program, Siemens also offers the development and construction of customized supplementary products, e.g. special operator panels and power supply systems.

Liability for defects

Of course we accept the same liability for defects for our complete equipment as for our SINUMERIK and SINAMICS products.

Furthermore, you can use our worldwide repair service anywhere and at any time.

Your benefits

One partner, one quotation, one order, one delivery, one invoice, and one contact partner for liability of defects.

For series production or individual items, Siemens is your competent partner for complete equipment.

Services and documentation

Spares on Web

Overview

Spares on Web – Identification of spare parts on the Internet



Spares on Web is a web-based tool for identifying spare parts. After you have entered the Article No. and serial number, the spare parts available for the relevant unit are displayed.

www.siemens.com/sow

Overview

mySupport documentation – Compiling personal documents



mySupport documentation is a web-based system for generating personalized documentation based on standard documents and is part of the Siemens Industry Online Support portal.

In mySupport, a personal document library can be created in the "Documentation" category. This library can be accessed online in mySupport or also be generated in various formats for offline use.

Previously, this functionality was available in the My Documentation Manager for configurable manuals. Due to the integration in mySupport, all entries of the Industry Online Support can now be imported into the personal document library, including FAQs or product notifications.

If you have already worked with the My Documentation Manager, all of the previously created libraries will continue to be available without restrictions in mySupport.

In addition, the personal library in mySupport can be shared with other mySupport users. In this way, a collection of relevant documents can be created very effectively and used together with other mySupport users all over the world.

You must register/log in for configuring and generating/managing.

Benefits

- Display
View, print or download standard documents or personalized documents
- Configure
Transfer standard documents or parts of them to personalized documents
- Generate/Manage
Generate and manage personalized documents in the formats PDF, RTF or XML in all available languages

Function

Opening mySupport documentation in the Industry Online Support portal

- About the product support, entry type "Manual":
<https://support.industry.siemens.com/cs/ww/en/ps/man>
By clicking on the required version of the manual and then "Show and configure", the manual opens in a modular view, where you can navigate from topic to topic. Here the direct link to a topic can be used and made available to other users. The selected document can be added to the personal library via "mySupport Cockpit" > "Add to mySupport documentation".
- Via the direct link
<https://support.industry.siemens.com/my/ww/en/documentation/advanced>
After logon/registration, the online help is displayed as the current document.

More information

You can find more information on the Internet at

- <https://support.industry.siemens.com/my/ww/en/documentation>
- https://support.industry.siemens.com/cs/helpcenter/en/index.htm?#persoenliche_bibliothek_aufbauen.htm

Services and documentation

Documentation

Overview

SINAMICS G120P built-in and wall-mounted units

A comprehensive range of documentation is available for SINAMICS G120P built-in and wall-mounted units. These documents include operating instructions and installation manuals, list manuals and a Getting Started guide.

Information is available in the following formats:

- PDF file
- Configuring documents/documentation available for downloading at:
<https://support.industry.siemens.com/cs/ww/en/ps/13218/man>
and
<https://support.industry.siemens.com/cs/ww/en/ps/13224>

SINAMICS G120P Cabinet

The documentation is provided as standard in PDF format on DVD-ROM, and comprises the following sections:

- Description
- Installation instructions
- Commissioning instructions
- Description of functions
- Maintenance information
- Lists of spare parts

as well as device-specific documentation, such as circuit diagrams, dimensional drawings, layout diagrams and terminal diagrams.

The documentation is provided in English/German as standard supplied with the device. The scope of delivery also includes a CD-ROM with the STARTER commissioning tool.

If one of the languages subsequently listed is required, when ordering this should be specified using the corresponding option order code (⇒ [Description of options](#)):

Language	Order code
English/French	D58
English/Spanish	D60
English/Italian	D80
English/Chinese	D91
English/Russian	D94

Configuring documents/documentation available for downloading at:
<https://support.industry.siemens.com/cs/ww/en/ps/13219/man>

Application

Explanations of the manuals:

- **Operating Instructions**
 contain all the information needed to install the device and make electrical connections, information about commissioning and a description of the inverter functions
Phases of use: Control cabinet construction, commissioning, operation, maintenance and servicing
- **Hardware Installation Manual**
 contains all relevant information about the intended use of the components of a system (technical specifications, interfaces, dimensional drawings, characteristics, or possible applications), information about installation and electrical connections and information about maintenance and servicing.
Phases of use: Control cabinet configuration/construction, maintenance and servicing
- **Operating and Installation Instructions (for inverter and accessories)**
 contain all relevant information about the intended use of the components, such as technical specifications, interfaces, dimensional drawings, characteristics, or possible applications.
Phases of use: Control cabinet configuration/construction
- **Configuration Manual EMC Installation Guidelines**
 contain all relevant information about EMC-compliant design of control cabinets
Phases of use: Control cabinet configuration/construction
- **List Manual**
 containing all parameters, function charts, and faults/warnings for the product/system as well as their meanings and setting options. It contains parameter data and fault/warning descriptions with functional correlations.
Phases of use: Commissioning of components that have already been connected, configuration of system functions, fault cause/diagnosis
- **Getting Started**
 providing information about getting started for the first-time user as well as references to additional information. It contains information about the basic steps to be taken during commissioning. The information in the other documentation should be carefully observed for all of the other work required.
Phases of use: Commissioning of components that have already been connected
- **Function Manual**
 contains all the relevant information about individual drive functions
Phases of use: Commissioning of components that have already been connected, configuration of system functions

Selection and ordering data

Description	Article No.
Decentralization with PROFIBUS DP/DPV1	ISBN-13:978-3-89578-218-3
Automation with PROFINET: Industrial Communication Based on Industrial Ethernet	ISBN: 978-3-89578-293-0

Description	Article No.
Manufacturer and service documentation	
EMC Design Guidelines	
• German	6FC5297-0AD30-0AP3
• English	6FC5297-0AD30-0BP3
• Italian	6FC5297-0AD30-0CP3
• French	6FC5297-0AD30-0DP3
• Spanish	6FC5297-0AD30-0EP3
• Chinese (simplified)	6FC5297-0AD30-0RP3

More information

Please send any queries or suggestions to
docu.motioncontrol@siemens.com

Services and documentation

Notes

Appendix



8/2	Certificates of suitability (approvals)
8/4	Software licenses
8/6	Subject index
8/8	Metal surcharges
8/11	Conversion tables
8/13	Conditions of sale and delivery

Appendix

Certificates of suitability (approvals)







Overview

Many of the products in this Catalog fulfill requirements, e.g. for UL, CSA or FM and are labeled with the corresponding approval designation.

All of the certificates of suitability, approvals, certificates, declarations of conformity, test certificates, e.g. CE, UL, Safety Integrated etc. have been performed with the associated system components as they are described in the Catalogs and Configuration Manuals.

The certificates are only valid if the products are used with the described system components, are installed according to the Installation Guidelines and used for their intended purpose.

In other cases, the vendor of these products is responsible for arranging for the issue of new certificates.

Test code	Tested by	Device series/ Component	Test standard	Product category/ File-No.
UL: Underwriters Laboratories <i>Independent public testing body in North America</i>				
	UL acc. to UL standard	SINUMERIK	Standard UL 508, CSA C22.2 No. 142	NRAQ/7.E164110 NRAQ/7.E217227
		SIMOTION	Standard UL 508, CSA C22.2 No. 142	NRAQ/7.E164110
	UL acc. to CSA standard	SINAMICS	Standard UL 508, 508C, 61800-5-1 CSA C22.2 No. 142, 274	NRAQ/7.E164110, NMMS/2/7/8.E192450, NMMS/2/7/8.E203250, NMMS/7.E214113, NMMS/7.E253831
				NMMS/2/7/8.E121068 NMMS/7.E355661 NMMS/7.E323473
	UL acc. to UL and CSA standards			
	UL acc. to UL standard	SIMODRIVE	Standard UL 508C, CSA C22.2 No. 274	NMMS/2/7/8.E192450 NMMS/7.E214113
		Motors	Standard UL 1004-1, 1004-6, 1004-8, CSA C22.2 No. 100	PRGY2/8.E227215 PRH2/8.E93429 PRHJ2/8.E342747 PRGY2/8.E253922 PRH2/8.E342746
	UL acc. to CSA standard			
	UL acc. to UL and CSA standards	Line/motor reactors	Standard UL 508, 506, 5085-1, 5085-2, 1561, CSA C22.2 No. 14, 47, 66.1-06, 66.2-06	XQNX2/8.E257859 NMTR2/8.E219022 NMMS2/8.E333628 XPTQ2/8.E257852 XPTQ2/8.E103521 NMMS2/8.E224872 XPTQ2/8.E354316 XPTQ2/8.E198309 XQNX2/8.E475972
		Line filters, dv/dt filters, sine-wave filters	UL 1283, CSA C22.2 No. 8	FOKY2/8.E70122
	Resistors	UL 508, 508C, CSA C22.2 No. 14, 274	NMTR2/8.E224314 NMMS2/8.E192450 NMTR2/8.E221095 NMTR2/8.E226619	
TUV: TÜV Rheinland of North America Inc. <i>Independent public testing body in North America, Nationally Recognized Testing Laboratory (NRTL)</i>				
TÜV: TÜV SÜD Product Service <i>Independent public testing body in Germany, Nationally Recognized Testing Laboratory (NRTL) for North America</i>				
	TUV according to UL and CSA standards	SINAMICS	NRTL listing according to standard UL 508C	U7V 12 06 20078 013 U7 11 04 20078 009 U7 11 04 20078 010 U7 11 04 20078 011
		SIMOTION	NRTL listing according to standard UL 508	U7V 13 03 20078 01
		SIMODRIVE	NRTL listing according to standard UL 508C, CSA C22.2. No. 14	CU 72090702
		Motion Control Encoder	NRTL listing according to UL 61010-1 CSA C22.2 No. 61010-1	U8V 10 06 20196 024

Certificates of suitability (approvals)

Overview (continued)

Test code	Tested by	Device series/ Component	Test standard	Product category/ File-No.
CSA: Canadian Standards Association <i>Independent public testing body in Canada</i>				
	CSA according to CSA standard	SINUMERIK	Standard CSA C22.2 No. 142	2252-01 : LR 102527
FMRC: Factory Mutual Research Corporation <i>Independent public testing body in North America</i>				
	FM according to FM standard	SINUMERIK	Standard FMRC 3600, FMRC 3611, FMRC 3810, ANSI/ISA S82.02.1	-
EAC: Ivanovo-Certificate <i>Independent public testing body in the Russian Federation</i>				
	EAC in according to EAC Directive	SINAMICS SINUMERIK SIMOTION	Standard IEC 61800-5-1/-2, IEC 61800-3	-
RCM: Australian Communications and Media Authority <i>Independent public testing body in Australia</i>				
	RCM according to EMC standard	SINAMICS SINUMERIK SIMOTION	Standard IEC AS 61800-3, EN 61800-3	-
KC: National Radio Research Agency <i>Independent public testing body in South Korea</i>				
	KC according to EMC standard	SINAMICS SINUMERIK SIMOTION	Standard KN 11	-
BIA <i>Federal Institute for Occupational Safety</i>				
-	Functional safety	SINAMICS SINUMERIK SIMOTION	Standard EN 61800-5-2	-
TÜV SÜD Rail				
-	Functional safety	SINAMICS SINUMERIK SIMOTION	Standard EN 61800-5-2	-

More information about certificates can be found online at:
<https://support.industry.siemens.com/cs/ww/en/ps/cert>

Appendix

Software licenses

Overview

Software types

Software requiring a license is categorized into types. The following software types have been defined:

- Engineering software
- Runtime software

Engineering software

This includes all software products for creating (engineering) user software, e.g. for configuring, programming, parameterizing, testing, commissioning or servicing.

Data generated with engineering software and executable programs can be duplicated for your own use or for use by third-parties free-of-charge.

Runtime software

This includes all software products required for plant/machine operation, e.g. operating system, basic system, system expansions, drivers, etc.

The duplication of the runtime software and executable programs created with the runtime software for your own use or for use by third-parties is subject to a charge.

You can find information about license fees according to use in the ordering data (e.g. in the catalog). Examples of categories of use include per CPU, per installation, per channel, per instance, per axis, per control loop, per variable, etc.

Information about extended rights of use for parameterization/configuration tools supplied as integral components of the scope of delivery can be found in the readme file supplied with the relevant product(s).

License types

Siemens Industry Automation & Drive Technologies offers various types of software license:

- Floating license
- Single license
- Rental license
- Rental floating license
- Trial license
- Demo license
- Demo floating license

Floating license

The software may be installed for internal use on any number of devices by the licensee. Only the concurrent user is licensed. The concurrent user is the person using the program. Use begins when the software is started. A license is required for each concurrent user.

Single license

Unlike the floating license, a single license permits only one installation of the software per license.

The type of use licensed is specified in the ordering data and in the Certificate of License (CoL). Types of use include for example per instance, per axis, per channel, etc.

One single license is required for each type of use defined.

Rental license

A rental license supports the "sporadic use" of engineering software. Once the license key has been installed, the software can be used for a specific period of time (the operating hours do not have to be consecutive).

One license is required for each installation of the software.

Rental floating license

The rental floating license corresponds to the rental license, except that a license is not required for each installation of the software. Rather, one license is required per object (for example, user or device).

Trial license

A trial license supports "short-term use" of the software in a non-productive context, e.g. for testing and evaluation purposes. It can be transferred to another license.

Demo license

The demo license support the "sporadic use" of engineering software in a non-productive context, for example, use for testing and evaluation purposes. It can be transferred to another license. After the installation of the license key, the software can be operated for a specific period of time, whereby usage can be interrupted as often as required.

One license is required per installation of the software.

Demo floating license

The demo floating license corresponds to the demo license, except that a license is not required for each installation of the software. Rather, one license is required per object (for example, user or device).

Certificate of license (CoL)

The CoL is the licensee's proof that the use of the software has been licensed by Siemens. A CoL is required for every type of use and must be kept in a safe place.

Downgrading

The licensee is permitted to use the software or an earlier version/release of the software, provided that the licensee owns such a version/release and its use is technically feasible.

Delivery versions

Software is constantly being updated. The following delivery versions

- PowerPack
- Upgrade

can be used to access updates.

Existing bug fixes are supplied with the ServicePack version.

PowerPack

PowerPacks can be used to upgrade to more powerful software. The licensee receives a new license agreement and CoL (Certificate of License) with the PowerPack. This CoL, together with the CoL for the original product, proves that the new software is licensed.

A separate PowerPack must be purchased for each original license of the software to be replaced.

Overview

Upgrade

An upgrade permits the use of a new version of the software on the condition that a license for a previous version of the product is already held.

The licensee receives a new license agreement and CoL with the upgrade. This CoL, together with the CoL for the previous product, proves that the new version is licensed.

A separate upgrade must be purchased for each original license of the software to be upgraded.

ServicePack

ServicePacks are used to debug existing products.

ServicePacks may be duplicated for use as prescribed according to the number of existing original licenses.

License key

Siemens Industry Automation & Drive Technologies supplies software products with and without license keys.

The license key serves as an electronic license stamp and is also the "switch" for activating the software (floating license, rental license, etc.).

The complete installation of software products requiring license keys includes the program to be licensed (the software) and the license key (which represents the license).

Software Update Service (SUS)

As part of the SUS contract, all software updates for the respective product are made available to you free of charge for a period of one year from the invoice date. The contract will automatically be extended for one year if it is not canceled three months before it expires.

The possession of the current version of the respective software is a basic condition for entering into an SUS contract.

You can download explanations concerning license conditions from www.siemens.com/automation/salesmaterial-as/catalog/en/terms_of_trade_en.pdf

Appendix

Subject index

	Page		Page
Numerics		E	
230 V AC auxiliary power supply (K74)	5/14	EMERGENCY OFF Category 0, 24 V DC (L57)	5/17
A		EMERGENCY OFF pushbutton, installed in the cabinet door (L45)	5/17
Adapter for PM230 Power Modules	4/95	EMERGENCY STOP Category 1, 24 V DC (L60)	5/18
Anti-condensation heating for cabinet (L55)	5/17	Energy efficiency	1/4, 3/4
Application	1/7	Energy efficiency classes in accordance with EN 50598	1/9
Applications	7/7	EPLAN	6/12
B		Equipment acceptance (F03 to F97)	5/14
BACnet MS/TP	2/9	EtherNet/IP	2/9
Basic Operator Panel (BOP-2)	4/93	Extension of the liability for defects (Q80 to Q85)	5/20
Blanking cover for PM230	4/95	F	
Braking Modules for PM330	4/80	Fan units for PM230 Power Modules	4/102
Braking resistors		Field Services	7/5
• for PM330	4/82	First environment (L00)	5/15
Braking unit (L62)	5/18	FLENDER couplings	3/16
C		FLN P1	2/9
Cabinet lighting with service socket (L50)	5/17	I	
Cable compartment (M07)	5/19	Industrial Ethernet	2/8
Certificates of suitability	8/2	Industry Mall	7/2
Clean Power version with integrated Line Harmonics Filter (L01)	5/15	Industry Services	7/4
Coated modules	3/5, 5/4	Information and Download Center	7/3
Compliance with standards	3/12	Information and ordering options on the Internet and on DVD	7/2
Communication overview	2/2	Installation kit for line-side cable connection, left, for PM330	4/99
Conditions of sale and delivery	8/14	Integrated Drive Systems (IDS)	4, 3/16
Configuring with EPLAN	6/12	Intelligent Operator Panel (IOP-2)	4/91, 5/5
Connection for external auxiliaries (L19)	5/17	Intertrace Catalog CA01	7/2
Connection kit	4/98	IOP-2 Handheld	4/91
Consulting Services	7/5	L	
Control cabinets	7/10	Labels (Y31 to Y33)	5/20
Couplings	3/16	Liability for defects (extension)	5/20
Crane transport aid	5/4	Line Harmonics Filter (Clean Power version)	5/15
Customer documentation (D02 to D94)	5/13	Line filters	
CU230P-2 Control Units	4/2, 5/14	• for PM230	4/30
D		• for PM330	4/74
Derating data		Line reactors	
• for PM230	4/25	• for PM330	4/76
• for PM240P-2	4/49	Line-side power components	
• for PM330	4/69	• for PM230	4/33
• for SINAMICS G120P Cabinet	5/28	• for PM240P-2	4/53
Documentation	7/14	• for PM330	4/79
Door mounting kit	4/92, 4/94	• for SINAMICS G120P Cabinet	5/31
Drive ES Engineering Software	6/10	M	
Drive selection	1/7	Main contactor (L13)	5/16
Drive Technology Configurator	6/3	Main switch incl. fuses (L26)	5/17
dv/dt filter compact plus VPL		Maintenance Services	7/5
• for PM330	4/88	Memory cards	4/96
• for SINAMICS G120P Cabinet (L07)	5/16	Metal surcharges	8/8
dv/dt filter plus VPL		Modbus RTU	2/9
• for PM240P-2	4/56	Modernization Services	7/5
• for PM330	4/85	Modular design	3/6
		Motor reactor (L08)	5/16
		Mounting set	
		• for PM230	4/101
		• for PM240P-2	4/101
		mySupport documentation	7/13

	Page		Page
N			
Nickel-plated busbars	5/4		
O			
Online Support	7/6		
Operating ranges			
• for PM330	4/70		
• for SINAMICS G120P Cabinet	5/29		
Operator panels	4/90		
Options for SINAMICS G120P Cabinet	5/10		
Ordering options on the Internet and on DVD	7/2		
Output reactors			
• for PM230	4/35		
• for PM240P-2	4/54		
• for PM330	4/83		
Overload capability			
• for PM330	4/70		
• for SINAMICS G120P Cabinet	5/30		
P			
Partners at Siemens	7/2		
PC inverter connection kit 2	4/98		
Plant Data Services	7/5		
Platform concept	1/5		
Power Modules			
• PM230, 0.37 kW to 90 kW	4/10		
• PM240P-2, 11 kW to 132 kW	4/42		
• PM330, 160 kW to 630 kW	4/58		
PROFIBUS	2/7		
PROFIdrive	2/6		
PROFINET	2/3		
Pt100 evaluation unit (L86)	5/19		
Push Through mounting frame for PM230	4/95		
Q			
Quality management according to EN ISO 9001	1/5		
R			
Rating plate data (T58 to T91)	5/20		
Recommended line-side power components or overcurrent protection devices			
• for PM230	4/33		
• for PM240P-2	4/53		
• for PM330	4/79		
• for SINAMICS G120P Cabinet	5/31		
Repair Services	7/5		
Replacement fan			
• for PM240P-2	4/104		
• for PM330	4/105		
Retrofit Services	7/5		
S			
SD card	4/96		
Security information	6/1		
Selection guide for frequency inverters, on the move	6/1		
Service Programs and Agreements	7/5		
Shield connection kits			
• for CU230P-2	4/99		
• for PM230	4/99		
• for PM240P-2	4/99		
Shield connection plates	4/99, 4/100		
SIMOTICS motors	1/8		
SINAMICS drive family	1/2		
SINAMICS G120 Smart Access	4/97		
SINAMICS G120P Cabinet	5/2		
SINAMICS SD card	4/96		
SINAMICS Selector App	6/1		
SINAMICS Startdrive	6/8		
SINAMICS Startdrive commissioning tool	6/8		
SinaSave energy efficiency tool	6/2		
Sine-wave filter			
• for PM230	4/40		
SIZER for Siemens Drives engineering tool	6/4		
SIZER WEB ENGINEERING engineering tool	6/5		
Smart Access	4/97		
Socket (M06)	5/19		
Software licenses	8/4		
Spare part kit for Control Units	4/100		
Spare parts	4/100		
Spare Parts Services	7/5		
Spares on Web	7/12		
Startdrive	6/8		
STARTER commissioning tool	6/6		
Supplementary system components	4/90		
Support Services	7/5		
T			
Technology function	3/7		
Terminal Cover Kit	4/101		
The SINAMICS drive family	1/2		
Thermistor motor protection unit (L83, L84)	5/18, 5/19		
Totally Integrated Automation (TIA)	1/2		
Training	7/8		
Training case	7/9		
Training Services	7/5		
Types of protection for cabinet units	5/4, 5/19		
U			
Update for the IOP-2	4/91		
USS	2/9		

Appendix

Metal surcharges

Explanation of the raw material/metal surcharges¹⁾

Surcharge calculation

To compensate for variations in the price of the raw materials silver, copper, aluminum, lead, gold, dysprosium²⁾ and/or neodym²⁾, surcharges are calculated on a daily basis using the so-called metal factor for products containing these raw materials. A surcharge for the respective raw material is calculated as a supplement to the price of a product if the basic official price of the raw material in question is exceeded.

The surcharges are calculated in accordance with the following criteria:

- Basic official price of the raw material
Basic official price from the day prior to receipt of the order or prior to release order (daily price) for³⁾
 - Silver (sales price, processed)
 - Gold (sales price, processed)
 and for⁴⁾
 - Copper (lower DEL notation + 1 %)
 - Aluminum (aluminum in cables)
 - Lead (lead in cables)
- Metal factor of the products
Certain products are displayed with a metal factor. The metal factor determines the official price (for those raw materials concerned) as of which the metal surcharges are applied and the calculation method used (weight or percentage method). An exact explanation is given below.

Structure of the metal factor

The metal factor consists of several digits; the first digit indicates whether the percentage method of calculation refers to the list price or a possible discounted price (customer net price) (L = list price / N = customer net price).

The remaining digits indicate the method of calculation used for the respective raw material. If no surcharge is added for a raw material, a "-" is used.

1st digit	List or customer net price using the percentage method
2nd digit	for silver (AG)
3rd digit	for copper (CU)
4th digit	for aluminum (AL)
5th digit	for lead (PB)
6th digit	for gold (AU)
7th digit	for dysprosium (Dy) ²⁾
8th digit	for neodym (Nd) ²⁾

Weight method

The weight method uses the basic official price, the daily price and the raw material weight. In order to calculate the surcharge, the basic official price must be subtracted from the daily price. The difference is then multiplied by the raw material weight.

The basic official price can be found in the table below using the number (1 to 9) of the respective digit of the metal factor. The raw material weight can be found in the respective product descriptions.

Percentage method

Use of the percentage method is indicated by the letters A-Z at the respective digit of the metal factor.

The surcharge is increased - dependent on the deviation of the daily price compared with the basic official price - using the percentage method in "steps" and consequently offers surcharges that remain constant within the framework of this "step range". A higher percentage rate is charged for each new step. The respective percentage level can be found in the table below.

Metal factor examples

L E A - - - - -	Basis for % surcharge: List price Silver Basis 150 €, Step 50 €, 0.5 % Copper Basis 150 €, Step 50 €, 0.1 % No surcharge for aluminum No surcharge for lead No surcharge for gold No surcharge for dysprosium No surcharge for neodym
N - A 6 - - - - -	Basis for % surcharge: Customer net price No surcharge for silver Copper Basis 150 €, Step 50 €, 0.1 % Aluminum acc. to weight, basic offic. price 225 € No surcharge for lead No surcharge for gold No surcharge for dysprosium No surcharge for neodym
- - - 3 - - - - -	No basis necessary No surcharge for silver Copper acc. to weight, basic official price 150 € No surcharge for aluminum No surcharge for lead No surcharge for gold No surcharge for dysprosium No surcharge for neodym

¹⁾ Refer to the separate explanation on the next page regarding the raw materials dysprosium and neodym (= rare earths).

²⁾ For a different method of calculation, refer to the separate explanation for these raw materials on the next page.

³⁾ Source: Umicore, Hanau (www.metalsmanagement.umicore.com).

⁴⁾ Source: Schutzvereinigung DEL-Notiz e.V. (www.del-notiz.org).

Explanation of the raw material/metal surcharges for dysprosium and neodym (rare earths)

Surcharge calculation

To compensate for variations in the price of the raw materials silver¹⁾, copper¹⁾, aluminum¹⁾, lead¹⁾, gold¹⁾, dysprosium and/or neodym, surcharges are calculated on a daily basis using the so-called metal factor for products containing these raw materials. The surcharge for dysprosium and neodym is calculated as a supplement to the price of a product if the basic official price of the raw material in question is exceeded.

The surcharge is calculated in accordance with the following criteria:

- Basic official price of the raw material²⁾
Three-month basic average price (see below) in the period before the quarter in which the order was received or the release order took place (= average official price) for
 - dysprosium (Dy metal, 99 % min. FOB China; USD/kg)
 - neodym (Nd metal, 99 % min. FOB China; USD/kg)
- Metal factor of the products
Certain products are displayed with a metal factor. The metal factor indicates (for those raw materials concerned) the basic official price as of which the surcharges for dysprosium and neodym are calculated using the weight method. An exact explanation of the metal factor is given below.

Three-month average price

The prices of rare earths vary according to the foreign currency, and there is no freely accessible stock exchange listing. This makes it more difficult for all parties involved to monitor changes in price. In order to avoid continuous adjustment of the surcharges, but to still ensure fair, transparent pricing, an average price is calculated over a three-month period using the average monthly foreign exchange rate from USD to EUR (source: European Central Bank). Since not all facts are immediately available at the start of each month, a one-month buffer is allowed before the new average price applies.

Examples of calculation of the average official price:

Period for calculation of the average price:	Period during which the order/release order is effected and the average price applies:
Sep 2012 - Nov 2012	Q1 in 2013 (Jan - Mar)
Dec 2012 - Feb 2013	Q2 in 2013 (Apr - Jun)
Mar 2013 - May 2013	Q3 in 2013 (Jul - Sep)
Jun 2013 - Aug 2013	Q4 in 2013 (Oct - Dec)

Structure of the metal factor

The metal factor consists of several digits; the first digit is not relevant to the calculation of dysprosium and neodym.

The remaining digits indicate the method of calculation used for the respective raw material. If no surcharge is added for a raw material, a "-" is used.

1st digit	List or customer net price using the percentage method
2nd digit	for silver (AG) ¹⁾
3rd digit	for copper (CU) ¹⁾
4th digit	for aluminum (AL) ¹⁾
5th digit	for lead (PB) ¹⁾
6th digit	for gold (AU) ¹⁾
7th digit	for dysprosium (Dy)
8th digit	for neodym (Nd)

Weight method

The weight method uses the basic official price, the average price and the raw material weight. In order to calculate the surcharge, the basic official price must be subtracted from the average price. The difference is then multiplied by the raw material weight.

The basic official price can be found in the table below using the number (1 to 9) of the respective digit of the metal factor. Your Sales contact can inform you of the raw material weight.

Metal factor examples

Metal factor	Description
-----71	No basis necessary
	No surcharge for silver
	No surcharge for copper
	No surcharge for aluminum
	No surcharge for lead
	No surcharge for gold
	Dysprosium acc. to weight, basic official price 300 €
	Neodym acc. to weight, basic official price 50 €

¹⁾ For a different method of calculation, refer to the separate explanation for these raw materials on the previous page.

²⁾ Source: Asian Metal Ltd (www.asianmetal.com)

Appendix

Metal surcharges

Values of the metal factor

Percentage method	Basic official price in €	Step range in €	% surcharge 1st step	% surcharge 2nd step	% surcharge 3rd step	% surcharge 4th step	% surcharge per additional step	
			Price in € 150.01 - 200.00	Price in € 200.01 - 250.00	Price in € 250.01 - 300.00	Price in € 300.01 - 350.00		
A	150	50	0.1	0.2	0.3	0.4	0.1	
B	150	50	0.2	0.4	0.6	0.8	0.2	
C	150	50	0.3	0.6	0.9	1.2	0.3	
D	150	50	0.4	0.8	1.2	1.6	0.4	
E	150	50	0.5	1.0	1.5	2.0	0.5	
F	150	50	0.6	1.2	1.8	2.4	0.6	
G	150	50	1.0	2.0	3.0	4.0	1.0	
H	150	50	1.2	2.4	3.6	4.8	1.2	
I	150	50	1.6	3.2	4.8	6.4	1.6	
J	150	50	1.8	3.6	5.4	7.2	1.8	
			175.01 - 225.00	225.01 - 275.00	275.01 - 325.00	325.01 - 375.00		
O	175	50	0.1	0.2	0.3	0.4	0.1	
P	175	50	0.2	0.4	0.6	0.8	0.2	
R	175	50	0.5	1.0	1.5	2.0	0.5	
			225.01 - 275.00	275.01 - 325.00	325.01 - 375.00	375.01 - 425.00		
S	225	50	0.2	0.4	0.6	0.8	0.2	
U	225	50	1.0	2.0	3.0	4.0	1.0	
V	225	50	1.0	1.5	2.0	3.0	1.0	
W	225	50	1.2	2.5	3.5	4.5	1.0	
			150.01 - 175.00	175.01 - 200.00	200.01 - 225.00	225.01 - 250.00		
Y	150	25	0.3	0.6	0.9	1.2	0.3	
			400.01 - 425.00	425.01 - 450.00	450.01 - 475.00	475.01 - 500.00		
Z	400	25	0.1	0.2	0.3	0.4	0.1	
Price basis (1st digit)								
L	Calculation based on the list price							
N	Calculation based on the customer net price (discounted list price)							
Weight method	Basic official price in €							
1	50	Calculation based on raw material weight						
2	100							
3	150							
4	175							
5	200							
6	225							
7	300							
8	400							
9	555							
Miscellaneous								
-	No metal surcharge							

Conversion tables

Rotary inertia (to convert from A to B, multiply by entry in table)

B \ A	lb-in ²	lb-ft ²	lb-in-s ²	lb-ft-s ² slug-ft ²	kg-cm ²	kg-cm-s ²	gm-cm ²	gm-cm-s ²	oz-in ²	oz-in-s ²
lb-in ²	1	6.94×10^{-3}	2.59×10^{-3}	2.15×10^{-4}	2.926	2.98×10^{-3}	2.92×10^3	2.984	16	4.14×10^{-2}
lb-ft ²	144	1	0.3729	3.10×10^{-2}	421.40	0.4297	4.21×10^5	429.71	2304	5.967
lb-in-s ²	386.08	2.681	1	8.33×10^{-2}	1.129×10^3	1.152	1.129×10^6	1.152×10^3	6.177×10^3	16
lb-ft-s ² slug-ft ²	4.63×10^3	32.17	12	1	1.35×10^4	13.825	1.355×10^7	1.38×10^4	7.41×10^4	192
kg-cm ²	0.3417	2.37×10^{-3}	8.85×10^{-4}	7.37×10^{-5}	1	1.019×10^{-3}	1000	1.019	5.46	1.41×10^{-2}
kg-cm-s ²	335.1	2.327	0.8679	7.23×10^{-2}	980.66	1	9.8×10^5	1000	5.36×10^3	13.887
gm-cm ²	3.417×10^{-4}	2.37×10^{-6}	8.85×10^{-7}	7.37×10^{-8}	1×10^{-3}	1.01×10^{-6}	1	1.01×10^{-3}	5.46×10^{-3}	1.41×10^{-5}
gm-cm-s ²	0.335	2.32×10^{-3}	8.67×10^{-4}	7.23×10^{-5}	0.9806	1×10^{-3}	980.6	1	5.36	1.38×10^{-2}
oz-in ²	0.0625	4.34×10^{-4}	1.61×10^{-4}	1.34×10^{-5}	0.182	1.86×10^{-4}	182.9	0.186	1	2.59×10^{-3}
oz-in-s ²	24.13	0.1675	6.25×10^{-2}	5.20×10^{-3}	70.615	7.20×10^{-2}	7.09×10^4	72.0	386.08	1

Torque (to convert from A to B, multiply by entry in table)

B \ A	lb-in	lb-ft	oz-in	N-m	kg-cm	kg-m	gm-cm	dyne-cm
lb-in	1	8.333×10^{-2}	16	0.113	1.152	1.152×10^{-2}	1.152×10^3	1.129×10^6
lb-ft	12	1	192	1.355	13.825	0.138	1.382×10^4	1.355×10^7
oz-in	6.25×10^{-2}	5.208×10^{-3}	1	7.061×10^{-3}	7.200×10^{-2}	7.200×10^{-4}	72.007	7.061×10^4
N-m	8.850	0.737	141.612	1	10.197	0.102	1.019×10^4	1×10^7
kg-cm	0.8679	7.233×10^{-2}	13.877	9.806×10^{-2}	1	10^{-2}	1000	9.806×10^5
kg-m	86.796	7.233	1.388×10^3	9.806	100	1	1×10^5	9.806×10^7
gm-cm	8.679×10^{-4}	7.233×10^{-5}	1.388×10^{-2}	9.806×10^{-5}	1×10^{-3}	1×10^{-5}	1	980.665
dyne-cm	8.850×10^{-7}	7.375×10^{-8}	1.416×10^{-5}	10^{-7}	1.0197×10^{-6}	1.019×10^{-8}	1.019×10^{-3}	1

Length (to convert from A to B, multiply by entry in table)

B \ A	inches	feet	cm	yd	mm	m
inches	1	0.0833	2.54	0.028	25.4	0.0254
feet	12	1	30.48	0.333	304.8	0.3048
cm	0.3937	0.03281	1	1.09×10^{-2}	10	0.01
yd	36	3	91.44	1	914.4	0.914
mm	0.03937	0.00328	0.1	1.09×10^{-3}	1	0.001
m	39.37	3.281	100	1.09	1000	1

Power (to convert from A to B, multiply by entry in table)

B \ A	hp	Watts
hp (English)	1	745.7
(lb-in) (deg./s)	2.645×10^{-6}	1.972×10^{-3}
(lb-in) (rpm)	1.587×10^{-5}	1.183×10^{-2}
(lb-ft) (deg./s)	3.173×10^{-5}	2.366×10^{-2}
(lb-ft) (rpm)	1.904×10^{-4}	0.1420
Watts	1.341×10^{-3}	1

Force (to convert from A to B, multiply by entry in table)

B \ A	lb	oz	gm	dyne	N
lb	1	16	453.6	4.448×10^5	4.4482
oz	0.0625	1	28.35	2.780×10^4	0.27801
gm	2.205×10^{-3}	0.03527	1	1.02×10^{-3}	N.A.
dyne	2.248×10^{-6}	3.59×10^{-5}	980.7	1	0.00001
N	0.22481	3.5967	N.A.	100000	1

Mass (to convert from A to B, multiply by entry in table)

B \ A	lb	oz	gm	kg	slug
lb	1	16	453.6	0.4536	0.0311
oz	6.25×10^{-2}	1	28.35	0.02835	1.93×10^{-3}
gm	2.205×10^{-3}	3.527×10^{-2}	1	10^{-3}	6.852×10^{-5}
kg	2.205	35.27	10^3	1	6.852×10^{-2}
slug	32.17	514.8	1.459×10^4	14.59	1

Rotation (to convert from A to B, multiply by entry in table)

B \ A	rpm	rad/s	degrees/s
rpm	1	0.105	6.0
rad/s	9.55	1	57.30
degrees/s	0.167	1.745×10^{-2}	1

Appendix

Conversion tables

Temperature Conversion

°F	°C	°C	°F
0	-17.8	-10	14
32	0	0	32
50	10	10	50
70	21.1	20	68
90	32.2	30	86
98.4	37	37	98.4
212	100	100	212
subtract 32 and multiply by $\frac{5}{9}$		multiply by $\frac{9}{5}$ and add 32	

Mechanism Efficiencies

Acme-screw with brass nut	~0.35–0.65
Acme-screw with plastic nut	~0.50–0.85
Ball-screw	~0.85–0.95
Chain and sprocket	~0.95–0.98
Preloaded ball-screw	~0.75–0.85
Spur or bevel-gears	~0.90
Timing belts	~0.96–0.98
Worm gears	~0.45–0.85
Helical gear (1 reduction)	~0.92

Friction Coefficients

Materials	μ
Steel on steel (greased)	~0.15
Plastic on steel	~0.15–0.25
Copper on steel	~0.30
Brass on steel	~0.35
Aluminum on steel	~0.45
Steel on steel	~0.58
Mechanism	μ
Ball bushings	<0.001
Linear bearings	<0.001
Dove-tail slides	~0.2++
Gibb ways	~0.5++

Material Densities

Material	lb-in ³	gm-cm ³
Aluminum	0.096	2.66
Brass	0.299	8.30
Bronze	0.295	8.17
Copper	0.322	8.91
Hard wood	0.029	0.80
Soft wood	0.018	0.48
Plastic	0.040	1.11
Glass	0.079–0.090	2.2–2.5
Titanium	0.163	4.51
Paper	0.025–0.043	0.7–1.2
Polyvinyl chloride	0.047–0.050	1.3–1.4
Rubber	0.033–0.036	0.92–0.99
Silicone rubber, without filler	0.043	1.2
Cast iron, gray	0.274	7.6
Steel	0.280	7.75

Wire Gauges¹⁾

Cross-section mm ²	Standard Wire Gauge (SWG)	American Wire Gauge (AWG)
0.2	25	24
0.3	23	22
0.5	21	20
0.75	20	19
1.0	19	18
1.5	17	16
2.5	15	13
4	13	11
6	12	9
10	9	7
16	7	6
25	5	3
35	3	2
50	0	1/0
70	000	2/0
95	00000	3/0
120	0000000	4/0
150	–	6/0
185	–	7/0

¹⁾ The table shows approximate SWG/AWG sizes nearest to standard metric sizes; the cross-sections do not match exactly.

1. General Provisions

By using this catalog you can acquire hardware and software products described therein from Siemens AG subject to the following Terms and Conditions of Sale and Delivery (hereinafter referred to as "T&C"). Please note that the scope, the quality and the conditions for supplies and services, including software products, by any Siemens entity having a registered office outside Germany, shall be subject exclusively to the General Terms and Conditions of the respective Siemens entity. The following T&C apply exclusively for orders placed with Siemens Aktiengesellschaft, Germany.

1.1 For customers with a seat or registered office in Germany

For customers with a seat or registered office in Germany, the following applies subordinate to the T&C:

- for installation work the "General Conditions for Erection Works – Germany"¹⁾ ("Allgemeine Montagebedingungen – Deutschland" (only available in German at the moment)) and/or
- for Plant Analytics Services the "Standard Terms and Conditions for Plant Analytics Services – for Customer in Germany"¹⁾ ("Allgemeine Geschäftsbedingungen für das Plant Analytics Services – für Kunden in Deutschland" (only available in German at the moment)) and/or
- for stand-alone software products and software products forming a part of a product or project, the "General License Conditions for Software Products for Automation and Drives for Customers with a Seat or registered Office in Germany"¹⁾ and/or
- for other supplies and/or services the "General Conditions for the Supply of Products and Services of the Electrical and Electronics Industry"¹⁾.

In case such supplies and/or services should contain Open Source Software, the conditions of which shall prevail over the "General Conditions for the Supply of Products and Services of the Electrical and Electronics Industry"¹⁾. A notice will be contained in the scope of delivery in which the applicable conditions for Open Source Software are specified. This shall apply mutatis mutandis for notices referring to other third party software components.

1.2 For customers with a seat or registered office outside Germany

For customers with a seat or registered office outside Germany, the following applies subordinate to the T&C:

- for Plant Analytics Services the "Standard Terms and Conditions for Plant Analytics Services"¹⁾ and/or
- for services the "International Terms & Conditions for Services"¹⁾ supplemented by "Software Licensing Conditions"¹⁾ and/or
- for other supplies of hard- and/or software the "International Terms & Conditions for Products"¹⁾ supplemented by "Software Licensing Conditions"¹⁾

1.3 For customers with master or framework agreement

To the extent our supplies and/or services offered are covered by an existing master or framework agreement, the terms and conditions of that agreement shall apply instead of T&C.

2. Prices

The prices are in € (Euro) ex point of delivery, exclusive of packaging.

The sales tax (value added tax) is not included in the prices. It shall be charged separately at the respective rate according to the applicable statutory legal regulations.

Prices are subject to change without prior notice. We will charge the prices valid at the time of delivery.

To compensate for variations in the price of raw materials (e.g. silver, copper, aluminum, lead, gold, dysprosium and neodym), surcharges are calculated on a daily basis using the so-called metal factor for products containing these raw materials. A surcharge for the respective raw material is calculated as a supplement to the price of a product if the basic official price of the raw material in question is exceeded.

The metal factor of a product indicates the basic official price (for those raw materials concerned) as of which the surcharges on the price of the product are applied, and with what method of calculation.

You will find a detailed explanation of the metal factor on the page headed "Metal surcharges".

To calculate the surcharge (except in the cases of dysprosium and neodym), the official price from the day prior to that on which the order was received or the release order was effected is used.

To calculate the surcharge applicable to dysprosium and neodym ("rare earths"), the corresponding three-month basic average price in the quarter prior to that in which the order was received or the release order was effected is used with a one-month buffer (details on the calculation can be found in the explanation of the metal factor).

3. Additional Terms and Conditions

The dimensions are in mm. In Germany, according to the German law on units in measuring technology, data in inches apply only to devices for export.

Illustrations are not binding.

Insofar as there are no remarks on the individual pages of this catalog - especially with regard to data, dimensions and weights given - these are subject to change without prior notice.

¹⁾ The text of the Terms and Conditions of Siemens AG can be downloaded at www.siemens.com/automation/salesmaterial-as/catalog/en/terms_of_trade_en.pdf

Appendix

Conditions of sale and delivery

4. Export regulations

We shall not be obligated to fulfill any agreement if such fulfillment is prevented by any impediments arising out of national or international foreign trade or customs requirements or any embargoes and/or other sanctions.

Export may be subject to license. We shall indicate in the delivery details whether licenses are required under German, European and US export lists.

Our products are controlled by the U.S. Government (when labeled with "ECCN" unequal "N") and authorized for export only to the country of ultimate destination for use by the ultimate consignee or end-user(s) herein identified. They may not be resold, transferred, or otherwise disposed of, to any other country or to any person other than the authorized ultimate consignee or end-user(s), either in their original form or after being incorporated into other items, without first obtaining approval from the U.S. Government or as otherwise authorized by U.S. law and regulations.

The export indications can be viewed in advance in the description of the respective goods on the Industry Mall, our online catalog system. Only the export labels "AL" and "ECCN" indicated on order confirmations, delivery notes and invoices are authoritative.

Products labeled with "AL" unequal "N" are subject to European / national export authorization. Products without label, with label "AL:N" / "ECCN:N", or label "AL:9X9999" / "ECCN: 9X9999" may require authorization from responsible authorities depending on the final end-use, or the destination.

If you transfer goods (hardware and/or software and/or technology as well as corresponding documentation, regardless of the mode of provision) delivered by us or works and services (including all kinds of technical support) performed by us to a third party worldwide, you must comply with all applicable national and international (re-)export control regulations.

If required for the purpose of conducting export control checks, you (upon request by us) shall promptly provide us with all information pertaining to the particular end customer, final disposition and intended use of goods delivered by us respectively works and services provided by us, as well as to any export control restrictions existing in this relation.

The products listed in this catalog may be subject to European/German and/or US export regulations. Any export requiring approval is therefore subject to authorization by the relevant authorities.

Errors excepted and subject to change without prior notice.

Further information can be obtained from our branch offices listed at www.siemens.com/automation-contact

Interactive Catalog on DVD	<i>Catalog</i>	Process Instrumentation and Analytics	<i>Catalog</i>
Products for Automation and Drives	CA 01	<i>Digital: Field Instruments for Process Automation</i>	FI 01
Building Control		<i>Digital: Display Recorders SIREC D</i>	MP 20
GAMMA Building Control	ET G1	<i>Digital: SIPART Controllers and Software</i>	MP 31
Drive Systems		Products for Weighing Technology	WT 10
SINAMICS G130 Drive Converter Chassis Units	D 11	<i>Digital: Process Analytical Instruments</i>	AP 01
SINAMICS G150 Drive Converter Cabinet Units		<i>Digital: Process Analytics, Components for Continuous Emission Monitoring</i>	AP 11
SINAMICS GM150, SINAMICS SM150 Medium-Voltage Converters	D 12	Low-Voltage Power Distribution and Electrical Installation Technology	
<i>Digital: SINAMICS PERFECT HARMONY GH180 Medium-Voltage Air-Cooled Drives (Germany Edition)</i>	D 15.1	SENTRON · SIVACON · ALPHA Protection, Switching, Measuring and Monitoring Devices, Switchboards and Distribution Systems	LV 10
SINAMICS G180 Converters – Compact Units, Cabinet Systems, Cabinet Units Air-Cooled and Liquid-Cooled	D 18.1	Standards-Compliant Components for Photovoltaic Plants	LV 11
SINAMICS S120 Chassis Format Converter Units	D 21.3	Electrical Components for the Railway Industry	LV 12
SINAMICS S120 Cabinet Modules		Power Monitoring Made Simple	LV 14
SINAMICS S150 Converter Cabinet Units		Components for Industrial Control Panels according to UL Standards	LV 16
SINAMICS S120 and SIMOTICS	D 21.4	3WT Air Circuit Breakers up to 4000 A	LV 35
SINAMICS DCM DC Converter, Control Module	D 23.1	3VT Molded Case Circuit Breakers up to 1600 A	LV 36
SINAMICS Inverters for Single-Axis Drives · Built-In Units	D 31.1	<i>Digital: SIVACON System Cubicles, System Lighting and System Air-Conditioning</i>	LV 50
SINAMICS Inverters for Single-Axis Drives · Distributed Inverters	D 31.2	<i>Digital: ALPHA Distribution Systems</i>	LV 51
<i>Digital: SINAMICS S210 Servo Drive System</i>	D 32	ALPHA FIX Terminal Blocks	LV 52
SINAMICS G120P and SINAMICS G120P Cabinet pump, fan, compressor converters	D 35	SIVACON S4 Power Distribution Boards	LV 56
LOHER VARIO High Voltage Motors Flameproof, Type Series 1PS4, 1PS5, 1MV4 and 1MV5 Frame Size 355 to 1000, Power Range 80 to 7100 kW	D 83.2	SIVACON 8PS Busbar Trunking Systems	LV 70
Three-Phase Induction Motors SIMOTICS HV, SIMOTICS TN	D 84.1	<i>Digital: DELTA Switches and Socket Outlets</i>	ET D1
High Voltage Three-phase Induction Motors SIMOTICS HV Series A-compact PLUS	D 84.9	Vacuum Switching Technology and Components for Medium Voltage	HG 11.01
<i>Digital: Modular Industrial Generators SIGENTICS M</i>	D 85.1	Motion Control	
Three-Phase Induction Motors SIMOTICS HV, Series H-compact	D 86.1	SINUMERIK 840 Equipment for Machine Tools	NC 62
Synchronous Motors with Permanent-Magnet Technology, HT-direct	D 86.2	SINUMERIK 808 Equipment for Machine Tools	NC 81.1
DC Motors	DA 12	SINUMERIK 828 Equipment for Machine Tools	NC 82
SIMOVERT PM Modular Converter Systems	DA 45	SIMOTION Equipment for Production Machines	PM 21
MICROMASTER 420/430/440 Inverters	DA 51.2	<i>Digital: Drive and Control Components for Cranes</i>	CR 1
MICROMASTER 411/COMBIMASTER 411	DA 51.3	Power Supply	
<u>Low-Voltage Three-Phase-Motors</u>		SITOP Power supply	KT 10.1
SIMOTOCS S-1FG1 Servo geared motors	D 41	Safety Integrated	
SIMOTICS Low-Voltage Motors	D 81.1	Safety Technology for Factory Automation	SI 10
SIMOTICS FD Low-Voltage Motors	D 81.8	SIMATIC HMI / PC-based Automation	
LOHER Low-Voltage Motors	D 83.1	Human Machine Interface Systems/ PC-based Automation	ST 80/ ST PC
<i>Digital: MOTOX Geared Motors</i>	D 87.1	SIMATIC Ident	
SIMOGEAR Geared Motors	MD 50.1	Industrial Identification Systems	ID 10
SIMOGEAR Electric-monorail geared motors Light-load and heavy-load applications	MD 50.8	SIMATIC Industrial Automation Systems	
SIMOGEAR Gearboxes with adapter	MD 50.11	Products for Totally Integrated Automation	ST 70
<u>Mechanical Driving Machines</u>		SIMATIC PCS 7 Process Control System System components	ST PCS 7
FLENDER Standard Couplings	MD 10.1	SIMATIC PCS 7 Process Control System Technology components	ST PCS 7 T
FLENDER High Performance Couplings	MD 10.2	Add-ons for the SIMATIC PCS 7 Process Control System	ST PCS 7 AO
FLENDER Backlash-free Couplings	MD 10.3	SIMATIC S7-400 advanced controller	ST 400
FLENDER SIP Standard industrial planetary gear units	MD 31.1	SIMATIC NET	
		Industrial Communication	IK PI
		SIRIUS Industrial Controls	
		<i>Digital: SIRIUS Industrial Controls</i>	IC 10

*Digital: These catalogs are only available as a PDF.***Information and Download Center**

Digital versions of the catalogs are available on the Internet at:

www.siemens.com/industry/infocenter

There you'll find additional catalogs in other languages.

Please note the section "Downloading catalogs" on page "Online services" in the appendix of this catalog.

Get more information

SINAMICS G120P and SINAMICS G120P Cabinet pump, fan, compressor converters:
www.siemens.com/sinamics-g120p

SINAMICS drive family:
www.siemens.com/sinamics

Integrated Drive Systems:
www.siemens.com/ids

Partners worldwide:
www.siemens.com/automation-contact

Siemens AG
Digital Factory Division
Motion Control
Postfach 31 80
91050 ERLANGEN
Germany

© Siemens AG 2018
Subject to change without prior notice
PDF (E86060-K5535-A101-A5-7600)
V6.MKKATA.LDT.121
KG 0618 HOF 242 En
Produced in Germany

The information provided in this catalog contains merely general descriptions or characteristics of performance which in case of actual use do not always apply as described or which may change as a result of further development of the products. An obligation to provide the respective characteristics shall only exist if expressly agreed in the terms of contract. Availability and technical specifications are subject to change without notice.

All product designations may be trademarks or product names of Siemens AG or supplier companies whose use by third parties for their own purposes could violate the rights of the owners.

Security information

Siemens provides products and solutions with industrial security functions that support the secure operation of plants, systems, machines and networks.

In order to protect plants, systems, machines and networks against cyber threats, it is necessary to implement – and continuously maintain – a holistic, state-of-the-art industrial security concept. Siemens' products and solutions constitute one element of such a concept.

Customers are responsible for preventing unauthorized access to their plants, systems, machines and networks. Such systems, machines and components should only be connected to an enterprise network or the internet if and to the extent such a connection is necessary and only when appropriate security measures (e.g. firewalls and/or network segmentation) are in place.

For additional information on industrial security measures that may be implemented, please visit
<https://www.siemens.com/industrialsecurity>.

Siemens' products and solutions undergo continuous development to make them more secure. Siemens strongly recommends that product updates are applied as soon as they are available and that the latest product versions are used. Use of product versions that are no longer supported, and failure to apply latest updates may increase customer's exposure to cyber threats.

To stay informed about product updates, subscribe to the Siemens Industrial Security RSS Feed under
<https://www.siemens.com/industrialsecurity>.

Please scan the
QR code for more
information on
SINAMICS G120P

