

W21Xdb

Flameproof Motors
European Market

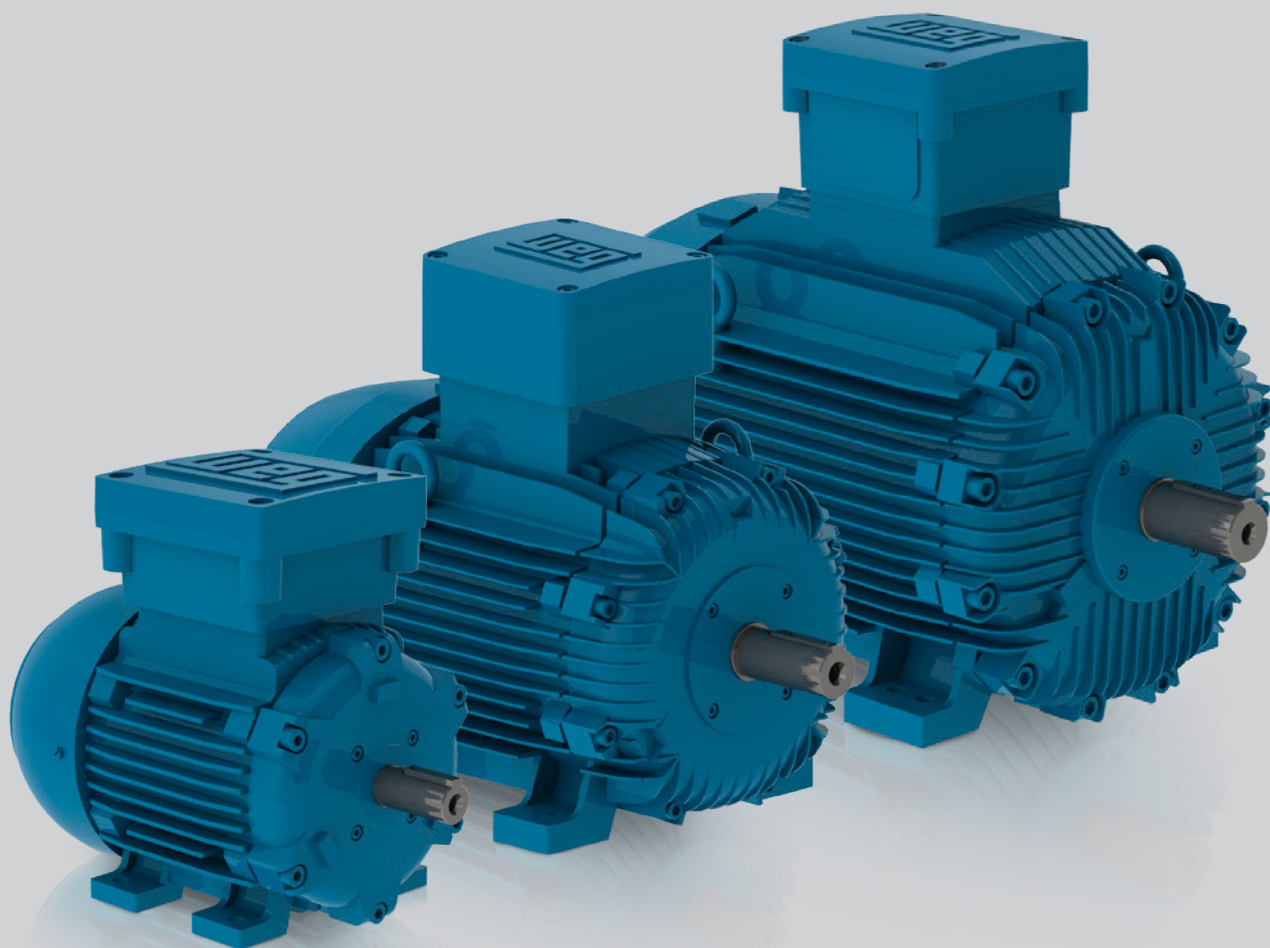

Motors | Automation | Energy | Transmission & Distribution | Coatings

Standards and Classification of Explosive Atmospheres



ATEX Directives

The ATEX Directives were adopted by the European Union (EU) to simplify free trade between member states whilst aligning the technical and legal requirements for products utilised in potentially explosive atmospheres.

The ATEX Product Directive 2014/34/EU (“ATEX 114”), effective from 20th April 2016 (and replacing the former 94/9/EC or “ATEX 95”), places responsibilities on the equipment manufacturer, whereas the Worker Protection Directive 1999/92/EC - “ATEX 153” (formerly “ATEX 137”) places obligations on the end user.

Manufacturers’ products must comply with the Essential Health and Safety Requirements for equipment intended for use in potentially explosive atmospheres, and follow a Conformity Assessment Procedure.

This Procedure requires the manufacturer to obtain from a Notified Body (“Ex NB”) an EC Type Examination Certificate for the relevant product(s), a Production Quality Assurance Notification (assessed and periodically audited by an ExNB) and the internal production control by the manufacturer to guarantee the products are in compliance with the ATEX Directive.

ATEX compliant products can be easily recognised by the explosion protection symbol  and the  mark certifying conformity with the Product Directive. Directive 1999/99/EC (“ATEX 153”) lays down the minimum requirements for improving the safety and health protection of workers at risk from explosive atmospheres, and also classifies the environment into zones and outlines which category of equipment can be used in each zone.

Further, the Directive highlights the responsibilities of End Users to assess potential risks of their workplaces and equipment, prepare an Explosion Protection Document and provide suitable warning signage for areas where explosive atmospheres may occur.

IECEx System

According to its website, www.iecex.com, the objective of the IECEx System is defined as the means “to facilitate international trade in equipment and services utilised in potentially explosive atmospheres, whilst maintaining the required level of safety”.

The IECEx System is based on the use of International Electrotechnical Commission (IEC) standards, and is a certification system which verifies compliance to those standards associated with the safe use of equipment in installations where a potential risk of fire or explosion may exist.

An IECEx Quality Assessment Report (“QAR”) is provided once the results of an on-site assessment of the manufacturer’s quality management system has been conducted by the ExCB, and found to be in compliance with the requirements of the IECEx Certified Equipment Scheme and, most importantly, the document IECEx OD 005.

Thereafter, the ExCB will review and endorse the ExTR and QAR and then issue the IECEx Certificate of Conformity (“CoC”).

IECEx certificates are issued electronically and are all available for viewing or printing on the IECEx public access website.



Hazardous Areas

According to the IEC 60079-10-1 and IEC 60079-10-2 standards, the definition of an Explosive Atmosphere is a “mixture with air, under atmospheric conditions, of flammable substances in the form of gas, vapors and dusts which, after ignition, permits self-sustaining propagation”.

A Hazardous Area is “an area in which an explosive atmosphere is or may be expected to be present, in quantities such as to require special precautions for the construction, installation and use of equipment”.

Explosions may occur either due to the transfer of flames or through overheating. For this reason, motors with flameproof protection are constructed in such a way as to prevent propagation of an internal explosion in to the hazardous area in which they are installed.

Hazardous areas are classified through Zones, Groups and Temperature Classes.

The classifications according to the International Electrotechnical Commission (IEC) are shown below:

Classification per Zones: based upon the frequency of the occurrence and duration of an explosive atmosphere and based on the type of flammable material (gases/vapors or dusts):

- **IEC Zone 0 (gases/vapours) or 20 (dusts)**
An explosive atmosphere with continuous grade of release
- **IEC Zone 1 (gases/vapours) or 21 (dusts)**
An explosive atmosphere with primary grade of release
- **IEC Zone 2 (gases/vapours) or 22 (dusts)**
An explosive atmosphere with secondary grade of release

Zone 2/22: area in which an explosive atmosphere is not likely to occur in normal operation but, if it does occur, will persist for a short period only

Zone 1/21: area in which an explosive atmosphere is likely to occur in normal operation occasionally

Zone 0/20: area in which an explosive atmosphere is present continuously or for long periods or frequently

(not applicable for motors and generators)

Classification per Groups: subdivision according to the type of flammable material present.

IEC Group I: gases present in underground coal mines (example: methane)

IEC Group II: gases present in other explosive atmospheres.

Group II subdivisions:

- **IEC Group IIA:** example: Propane
- **IEC Group IIB:** example: Ethylene
- **IEC Group IIC:** example: Hydrogen

IEC Group III: dusts

Group III subdivisions:

- **IEC Group IIIA:** solid particles, larger than 500 µm suspended - combustible dusts
- **IEC Group IIIB:** non-conductive dust, equal or smaller than 500 µm, with electrical resistivity greater than to 10³ Ω.m - grime
- **IEC Group IIIC:** conductive dust, equal or smaller than 500 µm, with electrical resistivity less than or equal to 10³ Ω.m - metallic dust

Classification per Temperature Classes: according to the temperature limitation, related to the ignition temperature of the flammable material present, IEC 60079-0 defines the limits for electrical equipment surface temperature for Groups I, II and III.

Group I - Underground Coal Mines (Methane and Coal Dust)

Conditions	Maximum surface temperature (°C) ¹⁾
Where coal dust is not likely to form a layer	450
Where coal dust can form a layer	150

Note: 1) On any surface of the enclosure.

Group II - Gases & Vapours

Temperature class IEC	Maximum surface temperature (°C)
T1	450
T2	300
T3	200
T4	135
T5	100
T6	85

Group III - Conductive Dusts

Conditions	Maximum surface temperature (°C) ¹⁾
With dust layers	Maximum surface temperature of the apparatus must be determined for a given depth of dust layer
Without dust layers	Maximum surface temperature of the apparatus shall not exceed the assigned value.

Note: 1) On any surface of the enclosure.

Equipment Protection Levels - EPL

In addition to the traditional hazardous area classification of the IEC 60079-10-1 and IEC 60079-10-2, which considers the possibility of an explosion occurring, IEC 60079-0, has introduced a new risk assessment approach known as the "Equipment Protection Level" that considers, besides the hazardous location itself, the consequences of a possible explosion. The primary intent of the EPL is to allow flexibility in the use of equipment in the various zones. For example it may be appropriate to use Gc equipment in a Zone 1 area where the amount of flammable gas / vapour is small and the location is unmanned virtually all of the time. Conversely Gb equipment may be selected in Zone 2 to allow this equipment to be used in the event of a persistent emergency condition. IEC 60079-14 explains in detail how to use EPL's in a risk assessment.

The EPL designations are defined as follows:

First Indices

- M** - Mines
- G** - Gas
- D** - Dust

Markings

The marking of Equipment meets the ATEX Directives and IECEx Scheme.

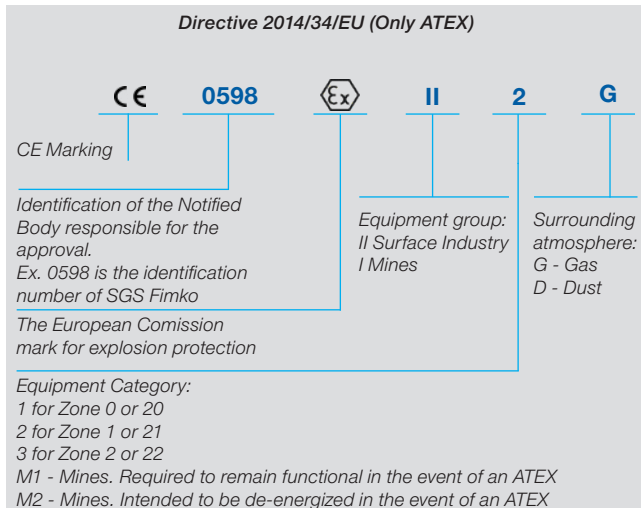

ATEX marking

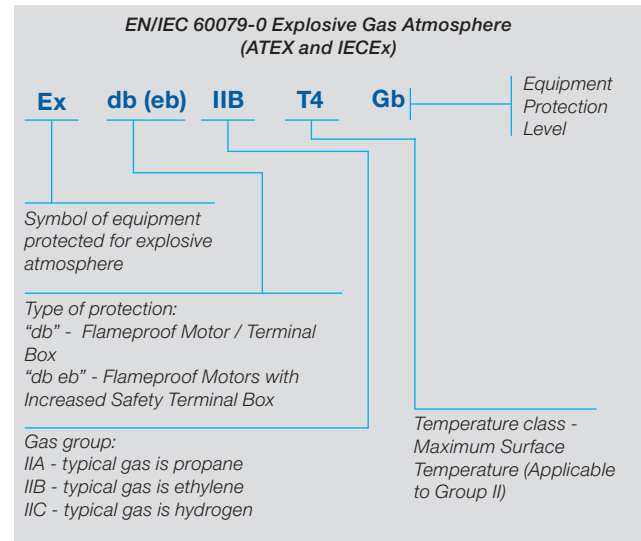

ATEX / IECEx marking for explosive gas atmosphere

Second Indices

- a** - Equipment having a very high level of protection
- b** - Equipment having a high level of protection
- c** - Equipment having an enhanced level of protection

Relationship between Groups, Zones and EPL's are detailed in the table below:

Group	Zone	EPL
Group I	-	Ma
		Mb
Group II	0	Ga
	1	Gb
	2	Gc
Group III	20	Da
	21	Db
	22	Dc

Certification

- TÜV Rheinland
- ATEX & IECEx certifications
- Zone 1
- Dust groups IIA and IIB
- Standards IEC 60079-0, 60079-1 & 60079-7



(1) EU-TYPE EXAMINATION CERTIFICATE

(2) Equipment and Protective Systems intended for use in Potentially Explosive Atmosphere - **Directive 2014/34/EU**

(3) EU-Type Examination Certificate Number

TÜV 15 ATEX 7769 X Issue: 01

(4) **Equipment:** Three phase asynchronous motor series **W21**, frame sizes 90S/L, 100L, 112M, 132S/M, 160M/L, 180M/L, 200M/L, 225S/M, 250S/M, 280S/M, 315S/M and 355M/L

(5) **Manufacturer:** **WEG Equipamentos Elétricos S/A**
(6) **Address:** Av. Prefeito Waldemar Graubas, 3000 - Vila Lalau Jaraguá do Sul - SC, CEP 89256-900, Brazil

(7) This product and any acceptable variation thereto are specified in the schedule to this certificate and the documents therein referred to.

(8) The certification body for ex-protected products of TÜV Rheinland Industrie Service GmbH, Notified Body No. 0035 in accordance with Article 21 of the Council Directive 2014/34/EU of 26th February 2014, certifies this equipment which has been found to comply with the Essential Health and Safety Requirements relating to the design and construction of equipment and protective systems intended for use in potentially explosive atmosphere, given in Annex II to the Directive.

The examination and test results are recorded in the confidential report 557 / Ex 7769.01 / 15 Compliance with the Essential Health and Safety Requirements, with the exception of those listed in the schedule of this certificate, has been assessed by reference to:

EN IEC 60079-0:2018 **EN 60079-1:2014** **EN IEC 60079-7:2015 / A1:2018**
EN 60079-31:2014

(10) If the sign "X" is placed after the certificate number, it indicates that the equipment is subject to special conditions for safe use specified in the schedule to this certificate.

(11) This EU-Type Examination Certificate relates only to the design and specification for construction of the equipment or protective system. It does not cover the process for actual manufacture or supply of the equipment or protective system, for which further requirements of the directive are applicable.

TÜV Rheinland Zertifizierungsstelle für Explosionsschutz Cologne, 2019-11-20

Dipl.-Ing. Christian Mehrhoff

This EU-Type Examination Certificate is valid only with the signature and stamp shall not be valid. This EU-Type Examination Certificate may only be used in conjunction with the original certificate. Extracts or alterations are subject to approval by the TÜV Rheinland Industrie Service GmbH, Notified Body No. 0035, Am Grauen Stein 51105 Köln, Tel. +49 (0) 221 806 114

www.tuv.com Precisely Right.

W21Xdb Flameproof Motors

W21Xdb is an flameproof motor especially designed to operate in environments with the presence of explosive atmospheres. It has robust construction, a flame retention system with gaps between the parts carefully designed, accurate machining on the terminal box and screws with high mechanical strength.

It meets the requirements of explosive atmospheres like Zone 1 and Zone 2, Groups IIA and IIB, T4.

Standard Features

- Three-phase
- Output: 0.37 to 330 kW
- Number of poles: 2 up to 8
- Frame sizes: IEC 90S/L up to 355M/L
- Voltage: 220-240/380-415 V (up to 100L)
380-415/660 V (112 and above)
- Frequency: 50Hz
- Efficiency Level: IE1 Standard Efficiency
IE2 High Efficiency
- Hazardous Area: Zone 1 – Gas Group IIB
- Temperature class: T4 (with inverter application T3)
- Certification marking: Ex db IIB T4 Gb
- Degree of protection: IP55
- Winding Thermal Protection: PTC 150 °C (1 per phase)
- Painting plan: 202E (C4 according to ISO 12944)
- Paint color: RAL 5010 (IE1 Motors)
RAL 5009 (IE2 Motors)
- Insulation class: “F” (DT80K)
- Cooling: TEFC
- Mounting: B3T
- Frame material: Cast iron frames
- Design: N
- Bearing seals:
 - Lip Seal: 90 up to 280 (all poles) 315 up to 355 (2-pole motors)
 - Taconite: 315-355 (4 up to 8 poles)
- Reinforced set screws
- Internal DE and NDE bearing cap to prevent flame propagation
- Grounding lug inside the terminal box
- Stainless steel nameplate identifying: standards, classification, temperature code, certification number

Optional Features

- Certification marking: Ex db eb IIB T4 Gb
- Increased safety terminal box (for Ex db eb motors)
 - Degree of Protection: IP56, IP65 or IP66 (W)
 - Bearing seals:
 - Lip seal
 - Oil seal
 - Taconite labyrinth seal and W3Seal and above
- Thermal protection:
 - PTC: frame 132 M and below
 - Thermostats
 - RTD-Pt100
- Space heaters
- Design H
- Stainless steel shaft
- Class “H” insulation
- Roller bearings for frame 160 M and above

Application

Environments containing flammable gases or vapour continuously, intermittently or periodically in enough amount to generate explosive or flammable mixtures arising out of repairs or maintenance services:

- Pumps
- Fans
- Crushers
- Conveyors
- Machine tools
- Milling machines
- Centrifugal machines
- Presses
- Elevators
- Looms
- Grinders
- Woodworking
- Cooling
- Packaging equipment

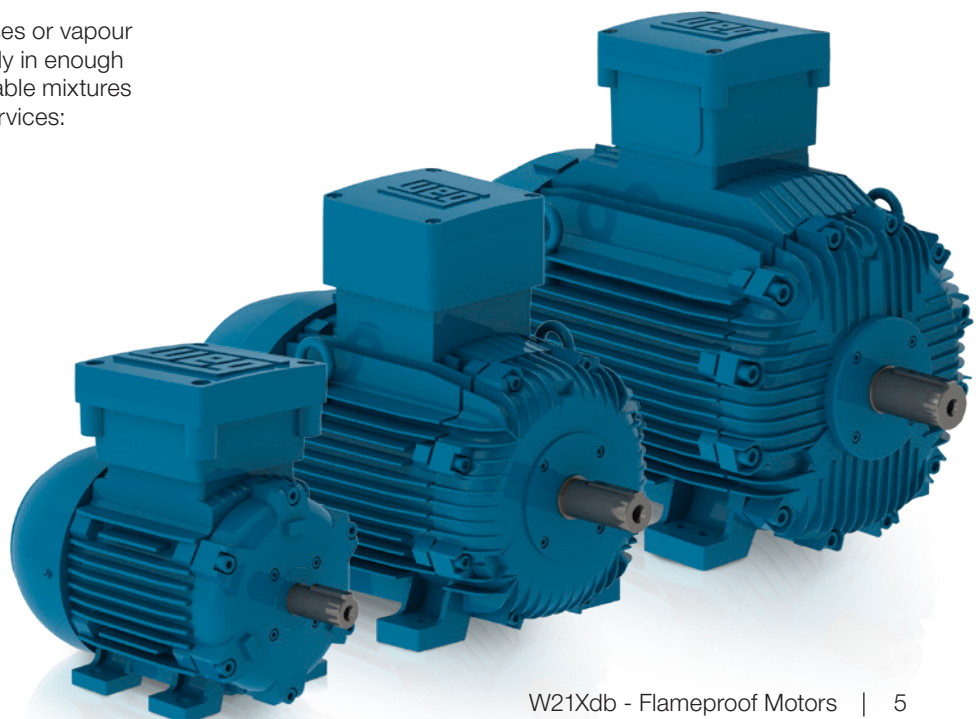

Ex db IIB T4 Gb

Output		380 V									415 V								
		Rated speed (rpm)	% of full load						Full load current In (A)	Rated speed (rpm)	% of full load						Full load current In (A)		
			Efficiency			Power Factor					Efficiency			Power Factor					
kW	HP	50	75	100	50	75	100		50	75	100	50	75	100					
II pole - 3000 rpm - 50 Hz																			
0,37	0,5	2885	62,0	69,0	69,4	0,76	0,82	0,86	0,942	2910	60,0	67,0	69,4	0,71	0,78	0,82	0,905		
0,55	0,75	2860	66,0	71,5	73,5	0,75	0,83	0,86	1,32	2900	64,0	70,0	73,0	0,70	0,79	0,82	1,28		
0,75	1	2870	71,0	75,0	76,5	0,73	0,81	0,86	1,70	2890	71,0	75,0	77,0	0,66	0,77	0,82	1,62		
1,5	2	2830	79,0	81,0	81,0	0,75	0,84	0,89	3,15	2850	78,0	81,0	81,0	0,68	0,79	0,85	2,98		
2,2	3	2820	81,0	82,0	82,0	0,75	0,84	0,87	4,61	2850	80,0	82,0	82,0	0,64	0,76	0,83	4,37		
3	4	2870	81,0	83,5	83,5	0,80	0,86	0,89	6,13	2900	81,0	83,5	83,5	0,74	0,84	0,87	5,75		
4	5,5	2880	84,0	85,5	85,2	0,80	0,86	0,89	7,83	2900	84,0	85,5	85,2	0,72	0,82	0,87	7,25		
5,5	7,5	2930	84,0	86,5	86,5	0,77	0,85	0,89	10,6	2940	83,0	86,5	86,5	0,69	0,80	0,85	10,2		
7,5	10	2910	85,0	86,5	87,0	0,80	0,87	0,90	14,5	2925	83,5	86,5	87,0	0,71	0,81	0,86	13,8		
9,2	12,5	2940	87,0	88,5	88,8	0,79	0,86	0,89	17,7	2950	86,7	88,5	88,8	0,74	0,83	0,87	16,6		
11	15	2940	87,5	89,0	89,0	0,79	0,85	0,88	21,3	2950	87,0	89,0	89,0	0,73	0,82	0,86	20,0		
15	20	2935	89,0	90,0	90,0	0,81	0,87	0,89	28,1	2950	88,0	90,0	90,0	0,72	0,81	0,87	26,3		
18,5	25	2940	90,0	90,5	90,5	0,78	0,86	0,89	34,9	2950	90,0	90,5	90,5	0,73	0,83	0,86	33,1		
22	30	2945	90,0	91,0	91,0	0,82	0,88	0,90	40,4	2955	89,0	91,0	91,0	0,75	0,84	0,87	38,2		
30	40	2960	90,0	91,7	91,7	0,79	0,86	0,88	56,5	2970	89,0	91,5	91,7	0,72	0,82	0,86	52,9		
37	50	2960	91,0	92,0	92,2	0,80	0,87	0,89	68,5	2965	90,5	92,0	92,2	0,70	0,81	0,86	64,9		
45	60	2960	91,5	92,7	92,7	0,85	0,89	0,91	80,4	2970	91,0	92,7	92,7	0,83	0,87	0,89	74,9		
55	75	2965	91,5	92,9	92,9	0,86	0,91	0,92	97,8	2970	91,0	93,0	93,0	0,82	0,88	0,91	90,4		
75	100	2975	91,5	93,3	93,5	0,84	0,88	0,90	134	2985	91,0	93,3	93,5	0,78	0,85	0,88	126		
90	125	2970	92,0	93,6	93,8	0,82	0,88	0,89	164	2980	91,5	93,6	93,8	0,77	0,86	0,88	152		
110	150	2976	93,0	93,8	94,0	0,80	0,87	0,88	202	2980	92,2	93,8	94,0	0,75	0,83	0,87	187		
132	175	2965	93,5	94,3	94,3	0,84	0,89	0,91	232	2970	93,0	94,3	94,3	0,80	0,87	0,90	214		
160	220	2970	90,0	94,6	94,6	0,86	0,90	0,91	280	2975	94,0	94,6	94,6	0,83	0,88	0,89	262		
185	250	2975	94,5	94,7	94,7	0,82	0,87	0,89	333	2980	94,5	94,7	94,7	0,78	0,84	0,87	312		
200	270	2980	93,0	94,7	94,9	0,90	0,92	0,92	347	2985	93,0	94,5	94,9	0,88	0,90	0,91	321		
250	340	2980	94,0	94,9	94,9	0,90	0,92	0,93	425	2985	93,5	94,9	94,9	0,87	0,91	0,92	393		
Optionals																			
1,1	1,5	2850	75,0	78,0	78,0	0,75	0,83	0,87	2,46	2880	74,0	77,0	78,0	0,68	0,79	0,84	2,34		
15	20	2935	89,0	90,0	90,0	0,81	0,87	0,89	28,1	2950	88,0	90,0	90,0	0,72	0,81	0,87	26,3		
75	100	2960	92,0	93,0	93,0	0,85	0,89	0,91	134	2965	92,0	93,0	93,3	0,81	0,87	0,90	123		
110	150	2976	93,0	93,8	94,0	0,80	0,87	0,88	202	2980	92,2	93,8	94,0	0,75	0,83	0,87	187		
185	250	2975	92,0	93,5	94,0	0,86	0,91	0,92	325	2980	92,0	93,5	94,0	0,83	0,88	0,91	299		
IV pole - 1500 rpm - 50 Hz																			
0,55	0,75	1460	74,0	77,0	77,0	0,62	0,73	0,79	1,37	1465	74,0	77,0	77,0	0,55	0,66	0,74	1,34		
1,1	1,5	1430	73,5	75,0	75,5	0,67	0,78	0,83	2,67	1445	70,5	76,2	76,2	0,56	0,69	0,78	2,57		
1,5	2	1425	74,5	76,0	77,2	0,67	0,79	0,85	3,47	1455	71,5	76,0	77,5	0,58	0,72	0,80	3,37		
2,2	3	1405	80,0	81,0	81,0	0,69	0,81	0,85	4,85	1430	79,0	81,0	81,0	0,61	0,75	0,81	4,66		
3	4	1390	80,5	81,5	81,5	0,70	0,80	0,86	6,46	1415	79,5	81,0	81,5	0,65	0,75	0,82	6,25		
4	5,5	1410	82,5	83,0	83,1	0,72	0,81	0,86	8,50	1435	81,5	83,0	83,1	0,62	0,74	0,82	8,17		
5,5	7,5	1460	84,5	86,5	86,5	0,72	0,82	0,86	11,2	1470	82,5	86,0	86,5	0,60	0,74	0,82	10,8		
7,5	10	1455	86,0	88,0	88,0	0,75	0,84	0,88	14,7	1465	85,0	87,0	88,0	0,65	0,77	0,83	14,2		
11	15	1455	88,0	89,0	89,0	0,70	0,80	0,84	22,4	1465	86,0	89,0	89,0	0,59	0,72	0,80	21,5		
15	20	1450	89,0	90,0	90,0	0,69	0,79	0,84	29,4	1460	88,0	90,0	90,0	0,63	0,75	0,81	27,8		
18,5	25	1465	90,0	91,0	91,0	0,72	0,81	0,85	36,1	1470	89,0	91,0	91,0	0,65	0,76	0,82	34,1		
22	30	1465	91,0	91,3	91,3	0,72	0,81	0,85	42,6	1475	90,0	91,3	91,3	0,63	0,75	0,81	40,8		
30	40	1470	91,5	92,0	92,0	0,78	0,84	0,86	57,2	1480	91,0	92,0	92,0	0,72	0,80	0,84	53,3		
37	50	1475	91,0	92,0	92,3	0,79	0,85	0,88	68,3	1480	90,0	92,0	92,3	0,72	0,82	0,86	63,7		
45	60	1475	91,0	92,5	92,7	0,80	0,87	0,89	82,2	1480	90,5	92,5	92,7	0,72	0,83	0,87	77,0		
55	75	1475	92,0	93,0	93,1	0,82	0,87	0,90	98,3	1480	92,0	93,0	93,1	0,77	0,85	0,89	91,9		
75	100	1480	91,0	92,5	92,8	0,82	0,87	0,88	140	1485	90,5	92,5	94,0	0,76	0,84	0,87	128		
90	125	1480	92,0	93,4	93,8	0,79	0,85	0,87	168	1485	91,5	93,4	93,8	0,75	0,83	0,86	155		
110	150	1480	92,0	93,3	94,0	0,79	0,85	0,87	204	1485	92,0	93,7	94,0	0,76	0,83	0,84	194		
132	175	1480	92,5	93,0	94,0	0,81	0,86	0,88	242	1485	92,0	93,5	94,3	0,76	0,84	0,87	224		
160	220	1480	93,0	94,2	94,6	0,78	0,85	0,88	290	1485	92,5	94,6	94,6	0,73	0,82	0,86	271		
200	270	1485	94,6	94,7	94,8	0,80	0,86	0,88	363	1490	94,5	94,7	94,8	0,76	0,84	0,86	339		
250	340	1485	94,0	94,7	94,8	0,82	0,87	0,89	446	1490	94,0	94,7	94,8	0,77	0,85	0,87	418		
280	380	1485	94,0	94,7	94,8	0,83	0,88	0,89	499	1490	94,0	94,7	94,8	0,79	0,86	0,87	467		
315	430	1485	94,0	94,7	94,8	0,83	0,87	0,89	560	1490	94,0	94,7	94,8	0,76	0,84	0,87	524		
330	450	1485	94,2	94,8	94,9	0,81	0,86	0,88	600	1490	94,2	94,8	94,9	0,77	0,84	0,86	563		
Optionals																			
0,75	1	1450	71,0	74,0	74,0	0,62	0,74	0,79	1,95	1460	70,0	74,0	74,0	0,54	0,68	0,74	1,91		
1,1	1,5	1390	73,5	75,0	75,5	0,67	0,80	0,85	2,60	1410	70,5	76,2	76,2	0,56	0,71	0,80	2,51		
4	5,5	1465	81,0	83,0	84,0	0,61	0,74	0,82	8,82	1470	80,0	83,0	84,5	0,54	0,68	0,77	8,55		
18,5	25	1465	90,0	91,0	91,0	0,72	0,81	0,85	36,1	1470	89,0	91,0	91,0	0,65	0,76	0,82	34,1		
75	100	1475	91,5	92,5	93,0	0,73	0,81	0,86	138	1480	92,0	92,6	93,0	0,67	0,79	0,85	132		
110	150	1480	92,0	93,3	94,0	0,79	0,85	0,87	204	1485	92,0	93,7	94,0	0,76	0,83	0,84	194		

W21Xdb Flameproof Motors - IE1 Standard Efficiency⁴⁾

Output kW / HP		Frame	Full Load Torque (Nm)	Locked Rotor Current I _L /I _n	Locked Rotor Torque T _L /T _n	Break- down Torque T _b /T _n	Inertia J (kgm ²)	Allowable locked rotor time (s)		Weight (kg)	Sound dB(A)	400 V						Full load current I _n (A)	
								Rated speed (rpm)	% of full load			Power Factor							
									Efficiency										
II pole - 3000 rpm - 50 Hz																			
0,37	0,5	90S	1,22	7,2	2,8	3,2	0,0018	40	88	30,5	64,0	2900	61,0	68,0	69,4	0,73	0,80	0,84	0,916
0,55	0,75	90S	1,82	7,0	2,8	3,2	0,0018	27	59	30,5	64,0	2880	65,0	71,0	74,0	0,72	0,81	0,84	1,28
0,75	1	90S	2,49	7,0	2,8	3,3	0,0018	25	55	31,7	64,0	2880	71,0	75,0	77,0	0,69	0,79	0,84	1,65
1,5	2	90S	5,05	6,5	2,4	2,8	0,0018	12	26	33,7	64,0	2840	79,0	81,0	81,0	0,72	0,81	0,87	3,03
2,2	3	90L	7,40	6,6	2,8	3,0	0,0023	9	20	35,8	64,0	2840	81,0	82,0	82,0	0,69	0,80	0,85	4,48
3	4	100L	9,92	7,2	2,6	2,8	0,0059	9	20	45,2	67,0	2890	81,0	83,5	83,5	0,77	0,85	0,88	5,89
4	5,5	112M	13,2	7,6	2,7	3,1	0,0081	15	33	59,9	64,0	2890	84,0	85,5	85,2	0,76	0,84	0,88	7,50
5,5	7,5	132S	17,9	8,0	2,7	3,2	0,0198	18	40	85,3	68,0	2935	84,0	86,5	86,5	0,73	0,82	0,87	10,3
7,5	10	132S	24,5	7,3	2,4	2,9	0,0206	10	22	83,3	68,0	2920	84,0	86,5	87,0	0,76	0,84	0,88	14,0
9,2	12,5	160M	29,9	7,8	2,6	3,1	0,0471	12	26	104	70,0	2945	86,5	88,5	88,8	0,76	0,84	0,88	17,0
11	15	160M	35,7	8,3	2,4	3,1	0,0452	12	26	142	70,0	2945	87,0	89,0	89,0	0,76	0,84	0,87	20,5
15	20	160M	48,7	7,8	2,5	3,2	0,0509	10	22	151	70,0	2945	89,0	90,0	90,0	0,76	0,84	0,88	27,0
18,5	25	160L	60,0	8,2	2,6	3,3	0,0622	10	22	168	70,0	2945	90,0	90,5	90,5	0,75	0,84	0,88	33,5
22	30	180M	71,3	8,2	2,8	3,1	0,1094	13	29	216	70,0	2950	90,0	91,0	91,0	0,78	0,86	0,89	38,7
30	40	200L	96,7	7,5	3,0	2,9	0,1958	19	42	280	74,0	2965	89,0	91,5	91,7	0,76	0,84	0,87	54,3
37	50	200L	119	7,5	2,9	2,9	0,2114	19	42	295	74,0	2965	91,0	92,0	92,2	0,75	0,84	0,88	65,8
45	60	225S/M	145	7,9	2,6	2,8	0,4276	24	53	460	82,0	2965	91,0	92,7	92,7	0,84	0,88	0,90	77,1
55	75	250S/M	177	8,5	2,8	3,0	0,4790	15	33	514	82,0	2965	91,5	93,0	93,0	0,84	0,89	0,91	93,8
75	100	280S/M	240	7,5	2,4	2,8	1,11	44	97	820	83,0	2980	91,4	93,3	93,5	0,81	0,87	0,89	129
90	125	280S/M	289	7,5	2,1	3,1	1,18	35	77	845	83,0	2975	92,0	93,6	93,8	0,79	0,87	0,89	156
110	150	315S/M	353	8,0	2,3	2,8	1,31	40	88	973	84,0	2979	93,0	93,8	94,0	0,78	0,85	0,87	194
132	175	315S/M	425	7,5	2,3	2,8	1,53	31	68	1034	84,0	2970	93,2	94,3	94,3	0,82	0,88	0,90	223
160	220	315S/M	515	7,3	2,2	2,5	1,97	25	55	1165	84,0	2970	90,0	94,6	94,6	0,85	0,89	0,90	269
185	250	315S/M	593	8,2	2,4	3,5	1,96	28	62	1010	84,0	2980	94,5	94,7	94,7	0,80	0,86	0,88	320
200	270	355M/L	640	7,2	1,8	2,6	4,56	70	154	1830	81,0	2985	93,0	94,6	94,9	0,89	0,91	0,92	329
250	340	355M/L	800	7,8	2,2	2,5	5,39	65	143	1972	81,0	2985	93,8	94,9	94,9	0,88	0,91	0,92	409
Optionals																			
1,1	1,5	90S	3,66	7,2	2,9	2,9	0,0018	15	33	31,7	64,0	2870	74,0	78,0	78,0	0,71	0,81	0,85	2,39
15	20	160L	48,7	7,8	2,5	3,2	0,0509	10	22	111	70,0	2945	89,0	90,0	90,0	0,76	0,84	0,88	27,0
75	100	250S/M	242	8,3	3,0	3,4	0,5303	10	22	570	82,0	2965	92,0	93,0	93,3	0,83	0,88	0,90	129
110	150	280S/M	353	8,0	2,3	2,8	1,31	40	88	878	83,0	2979	93,0	93,8	94,0	0,78	0,85	0,87	194
185	250	355M/L	593	7,0	1,8	2,0	4,02	70	154	1430	81,0	2980	92,0	93,5	94,0	0,85	0,90	0,92	307
IV pole - 1500 rpm - 50 Hz																			
0,55	0,75	90S	3,60	6,4	2,4	3,0	0,0038	17	37	32,2	49,0	1460	74,0	77,0	77,0	0,58	0,69	0,76	1,36
1,1	1,5	90S	7,30	5,5	2,1	2,5	0,0039	9	20	32,4	49,0	1440	72,5	76,2	76,2	0,61	0,73	0,80	2,60
1,5	2	90L	9,92	6,4	2,5	2,5	0,0056	9	20	35,0	49,0	1445	73,0	76,0	77,5	0,63	0,75	0,82	3,41
2,2	3	100L	14,8	6,7	2,7	2,5	0,0082	14	31	44,9	53,0	1420	80,0	81,0	81,0	0,65	0,78	0,83	4,72
3	4	100L	20,4	6,7	2,5	2,6	0,0092	8	18	45,0	53,0	1405	80,0	81,5	81,5	0,68	0,78	0,84	6,33
4	5,5	112M	26,8	6,9	2,0	2,3	0,0161	10	22	61,8	56,0	1425	82,5	83,0	83,1	0,67	0,78	0,84	8,27
5,5	7,5	132S	35,9	8,0	2,4	3,0	0,0426	10	22	80,8	60,0	1465	84,0	86,5	86,5	0,65	0,78	0,84	10,9
7,5	10	132M	49,1	8,0	2,5	2,8	0,0530	8	18	92,1	60,0	1460	86,0	88,0	88,0	0,70	0,80	0,86	14,2
11	15	160M	72,0	6,3	2,3	2,5	0,0779	16	35	142	67,0	1460	87,0	89,0	89,0	0,64	0,76	0,82	21,8
15	20	160L	98,5	6,0	2,3	2,4	0,1020	13	29	164	67,0	1455	89,0	90,0	90,0	0,65	0,76	0,82	28,4
18,5	25	180M	120	7,0	2,7	2,8	0,1740	18	40	211	64,0	1470	89,5	91,0	91,0	0,68	0,79	0,84	34,5
22	30	180L	143	7,5	2,8	2,8	0,2088	14	31	228	64,0	1470	91,0	91,3	91,3	0,67	0,78	0,83	41,4
30	40	200L	194	6,5	2,2	2,5	0,3202	17	37	290	69,0	1475	91,0	92,0	92,0	0,75	0,82	0,85	54,8
37	50	225S/M	239	7,2	2,3	2,7	0,6107	20	44	405	70,0	1480	91,0	92,0	92,3	0,76	0,84	0,87	65,4
45	60	225S/M	292	7,0	2,3	2,7	0,7464	16	35	434	70,0	1475	90,5	92,5	92,7	0,76	0,85	0,88	78,9
55	75	250S/M	356	7,0	2,3	2,6	0,9471	16	35	509	70,0	1475	92,0	93,0	93,2	0,78	0,86	0,89	95,2
75	100	280S/M	483	7,0	2,1	2,4	1,85	31	68	777	76,0	1485	91,0	92,5	93,0	0,79	0,85	0,87	134
90	125	280S/M	579	7,1	2,4	2,5	2,34	31	68	869	76,0	1485	92,0	93,4	93,8	0,77	0,84	0,86	161
110	150	315S/M	708	7,1	2,2	2,5	2,71	27	59	1036	77,0	1485	92,0	93,7	94,0	0,78	0,85	0,87	194
132	175	315S/M	849	7,5	2,3	2,6	3,25	13	29	1121	77,0	1485	92,5	93,5	94,3	0,78	0,85	0,87	232
160	220	315S/M	1033	7,0	2,4	2,7	3,63	22	48	1190	77,0	1480	92,5	94,6	94,6	0,75	0,83	0,87	278
200	270	355M/L	1283	6,6	2,3	2,2	6,34	44	97	1808	79,0	1490	94,6	94,7	94,8	0,78	0,85	0,87	348

Notes: 1) Insulation class "F" ΔT105K.
 2) The motors can also operate at a 60 Hz supply. The change in performance data can be obtained directly from the local WEG representative.
 3) The values shown in the electric tables are subjected to change without prior notice.
 4) Efficiency values are given according to IEC 60034-2-1. They are calculated according to indirect method, with stray load losses determined by measurement.

Ex db IIB T4 Gb

Output		380 V								415 V							
		Rated speed (rpm)	% of full load						Full load current In (A)	Rated speed (rpm)	% of full load						Full load current In (A)
			Efficiency			Power Factor					Efficiency			Power Factor			
kW	HP	50	75	100	50	75	100		50	75	100	50	75	100			
II pole - 3000 rpm - 50 Hz																	
0,37	0,5	2885	62,0	69,0	69,4	0,76	0,82	0,86	0,942	2910	60,0	67,0	69,4	0,71	0,78	0,82	0,905
0,55	0,75	2860	66,0	71,5	73,5	0,75	0,83	0,86	1,32	2900	64,0	70,0	73,0	0,70	0,79	0,82	1,28
0,75	1	2870	71,0	75,0	76,5	0,73	0,81	0,86	1,70	2890	71,0	75,0	77,0	0,66	0,77	0,82	1,62
1,5	2	2830	79,0	81,0	81,0	0,75	0,84	0,89	3,15	2850	78,0	81,0	81,0	0,68	0,79	0,85	2,98
2,2	3	2820	81,0	82,0	82,0	0,75	0,84	0,87	4,61	2850	80,0	82,0	82,0	0,64	0,76	0,83	4,37
3	4	2870	81,0	83,5	83,5	0,80	0,86	0,89	6,13	2900	81,0	83,5	83,5	0,74	0,84	0,87	5,75
4	5,5	2880	84,0	85,5	85,2	0,80	0,86	0,89	7,83	2900	84,0	85,5	85,2	0,72	0,82	0,87	7,25
5,5	7,5	2930	84,0	86,5	86,5	0,77	0,85	0,89	10,6	2940	83,0	86,5	86,5	0,69	0,80	0,85	10,2
7,5	10	2910	85,0	86,5	87,0	0,80	0,87	0,90	14,5	2925	83,5	86,5	87,0	0,71	0,81	0,86	13,8
9,2	12,5	2940	87,0	88,5	88,8	0,79	0,86	0,89	17,7	2950	86,7	88,5	88,8	0,74	0,83	0,87	16,6
11	15	2940	87,5	89,0	89,0	0,79	0,85	0,88	21,3	2950	87,0	89,0	89,0	0,73	0,82	0,86	20,0
15	20	2935	89,0	90,0	90,0	0,81	0,87	0,89	28,1	2950	88,0	90,0	90,0	0,72	0,81	0,87	26,3
18,5	25	2940	90,0	90,5	90,5	0,78	0,86	0,89	34,9	2950	90,0	90,5	90,5	0,73	0,83	0,86	33,1
22	30	2945	90,0	91,0	91,0	0,82	0,88	0,90	40,4	2955	89,0	91,0	91,0	0,75	0,84	0,87	38,2
30	40	2960	90,0	91,7	91,7	0,79	0,86	0,88	56,5	2970	89,0	91,5	91,7	0,72	0,82	0,86	52,9
37	50	2960	91,0	92,0	92,2	0,80	0,87	0,89	68,5	2965	90,5	92,0	92,2	0,70	0,81	0,86	64,9
45	60	2960	91,5	92,7	92,7	0,85	0,89	0,91	80,4	2970	91,0	92,7	92,7	0,83	0,87	0,89	74,9
55	75	2965	91,5	92,9	92,9	0,86	0,91	0,92	97,8	2970	91,0	93,0	93,0	0,82	0,88	0,91	90,4
75	100	2975	91,5	93,3	93,5	0,84	0,88	0,90	134	2985	91,0	93,3	93,5	0,78	0,85	0,88	126
90	125	2970	92,0	93,6	93,8	0,82	0,88	0,89	164	2980	91,5	93,6	93,8	0,77	0,86	0,88	152
110	150	2976	93,0	93,8	94,0	0,80	0,87	0,88	202	2980	92,2	93,8	94,0	0,75	0,83	0,87	187
132	175	2965	93,5	94,3	94,3	0,84	0,89	0,91	232	2970	93,0	94,3	94,3	0,80	0,87	0,90	214
160	220	2970	90,0	94,6	94,6	0,86	0,90	0,91	280	2975	94,0	94,6	94,6	0,83	0,88	0,89	262
185	250	2975	94,5	94,7	94,7	0,82	0,87	0,89	333	2980	94,5	94,7	94,7	0,78	0,84	0,87	312
200	270	2980	93,0	94,7	94,9	0,90	0,92	0,92	347	2985	93,0	94,5	94,9	0,88	0,90	0,91	321
250	340	2980	94,0	94,9	94,9	0,90	0,92	0,93	425	2985	93,5	94,9	94,9	0,87	0,91	0,92	393
Optionals																	
1,1	1,5	2850	75,0	78,0	78,0	0,75	0,83	0,87	2,46	2880	74,0	77,0	78,0	0,68	0,79	0,84	2,34
15	20	2935	89,0	90,0	90,0	0,81	0,87	0,89	28,1	2950	88,0	90,0	90,0	0,72	0,81	0,87	26,3
75	100	2960	92,0	93,0	93,0	0,85	0,89	0,91	134	2965	92,0	93,0	93,3	0,81	0,87	0,90	123
110	150	2976	93,0	93,8	94,0	0,80	0,87	0,88	202	2980	92,2	93,8	94,0	0,75	0,83	0,87	187
185	250	2975	92,0	93,5	94,0	0,86	0,91	0,92	325	2980	92,0	93,5	94,0	0,83	0,88	0,91	299
IV pole - 1500 rpm - 50 Hz																	
0,55	0,75	1460	74,0	77,0	77,0	0,62	0,73	0,79	1,37	1465	74,0	77,0	77,0	0,55	0,66	0,74	1,34
1,1	1,5	1430	73,5	75,0	75,5	0,67	0,78	0,83	2,67	1445	70,5	76,2	76,2	0,56	0,69	0,78	2,57
1,5	2	1425	74,5	76,0	77,2	0,67	0,79	0,85	3,47	1455	71,5	76,0	77,5	0,58	0,72	0,80	3,37
2,2	3	1405	80,0	81,0	81,0	0,69	0,81	0,85	4,85	1430	79,0	81,0	81,0	0,61	0,75	0,81	4,66
3	4	1390	80,5	81,5	81,5	0,70	0,80	0,86	6,46	1415	79,5	81,0	81,5	0,65	0,75	0,82	6,25
4	5,5	1410	82,5	83,0	83,1	0,72	0,81	0,86	8,50	1435	81,5	83,0	83,1	0,62	0,74	0,82	8,17
5,5	7,5	1460	84,5	86,5	86,5	0,72	0,82	0,86	11,2	1470	82,5	86,0	86,5	0,60	0,74	0,82	10,8
7,5	10	1455	86,0	88,0	88,0	0,75	0,84	0,88	14,7	1465	85,0	87,0	88,0	0,65	0,77	0,83	14,2
11	15	1455	88,0	89,0	89,0	0,70	0,80	0,84	22,4	1465	86,0	89,0	89,0	0,59	0,72	0,80	21,5
15	20	1450	89,0	90,0	90,0	0,69	0,79	0,84	29,4	1460	88,0	90,0	90,0	0,63	0,75	0,81	27,8
18,5	25	1465	90,0	91,0	91,0	0,72	0,81	0,85	36,1	1470	89,0	91,0	91,0	0,65	0,76	0,82	34,1
22	30	1465	91,0	91,3	91,3	0,72	0,81	0,85	42,6	1475	90,0	91,3	91,3	0,63	0,75	0,81	40,8
30	40	1470	91,5	92,0	92,0	0,78	0,84	0,86	57,2	1480	91,0	92,0	92,0	0,72	0,80	0,84	53,3
37	50	1475	91,0	92,0	92,3	0,79	0,85	0,88	68,3	1480	90,0	92,0	92,3	0,72	0,82	0,86	63,7
45	60	1475	91,0	92,5	92,7	0,80	0,87	0,89	82,2	1480	90,5	92,5	92,7	0,72	0,83	0,87	77,0
55	75	1475	92,0	93,0	93,1	0,82	0,87	0,90	98,3	1480	92,0	93,0	93,1	0,77	0,85	0,89	91,9
75	100	1480	91,0	92,5	92,8	0,82	0,87	0,88	140	1485	90,5	92,5	94,0	0,76	0,84	0,87	128
90	125	1480	92,0	93,4	93,8	0,79	0,85	0,87	168	1485	91,5	93,4	93,8	0,75	0,83	0,86	155
110	150	1480	92,0	93,3	94,0	0,79	0,85	0,87	204	1485	92,0	93,7	94,0	0,76	0,83	0,84	194
132	175	1480	92,5	93,0	94,0	0,81	0,86	0,88	242	1485	92,0	93,5	94,3	0,76	0,84	0,87	224
160	220	1480	93,0	94,2	94,6	0,78	0,85	0,88	290	1485	92,5	94,6	94,6	0,73	0,82	0,86	271
200	270	1485	94,6	94,7	94,8	0,80	0,86	0,88	363	1490	94,5	94,7	94,8	0,76	0,84	0,86	339

W21Xdb Flameproof Motors - IE2 High Efficiency⁴⁾

Output kW HP		Frame	Full Load Torque (Nm)	Locked Rotor Current I _L /I _n	Locked Rotor Torque T _L /T _n	Break- down Torque T _b /T _n	Inertia J (kgm ²)	Allowable locked rotor time (s)		Weight (kg)	Sound dB(A)	400 V											
												Rated speed (rpm)	% of full load			Full load current I _n (A)							
													Efficiency				Power Factor						
																	50	75	100	50	75	100	
II pole - 3000 rpm - 50 Hz																							
0,75	1	90S	2,49	7,8	3,0	3,4	0,0012	20	44	30,5	62,0	2880	75,0	79,0	80,0	0,65	0,75	0,82	1,65				
1,1	1,5	90S	3,66	7,6	2,9	2,9	0,0014	14	31	30,5	62,0	2870	78,0	81,0	81,5	0,67	0,78	0,84	2,28				
1,5	2	90S	5,07	5,9	2,6	2,6	0,0016	12	26	17,5	62,0	2825	81,0	81,3	81,6	0,66	0,78	0,84	3,16				
2,2	3	90L	7,36	7,8	3,5	3,4	0,0023	10	22	36,0	62,0	2855	83,0	84,0	84,2	0,63	0,76	0,83	4,47				
3	4	100L	9,88	8,5	3,0	3,8	0,0059	9	20	42,0	67,0	2900	84,5	85,8	86,0	0,73	0,80	0,86	5,85				
4	5,5	112M	13,3	6,8	2,3	2,9	0,0066	16	35	60,0	64,0	2870	86,0	86,0	86,0	0,78	0,86	0,89	7,54				
5,5	7,5	132S	18,1	6,8	2,2	3,0	0,0162	17	37	85,4	67,0	2910	86,5	88,0	88,0	0,68	0,79	0,85	10,6				
7,5	10	132S	24,5	7,3	2,5	3,0	0,0198	10	22	81,3	67,0	2925	86,5	88,0	88,8	0,67	0,79	0,85	14,2				
9,2	12,5	160M	29,8	8,5	2,5	3,2	0,0452	15	33	145	70,0	2955	86,5	89,5	90,0	0,72	0,82	0,86	17,0				
11	15	160M	35,5	9,0	2,7	3,7	0,0509	14	31	151	70,0	2960	89,0	90,8	90,8	0,70	0,80	0,85	20,6				
15	20	160M	48,7	7,8	2,5	3,2	0,0509	10	22	152	70,0	2945	89,5	90,8	91,0	0,74	0,83	0,87	27,1				
18,5	25	160L	60,0	8,2	2,6	3,3	0,0622	10	22	169	70,0	2945	90,3	91,3	91,3	0,75	0,84	0,87	33,3				
22	30	180M	71,1	8,5	2,6	3,3	0,1149	13	29	218	70,0	2955	91,0	92,0	92,0	0,76	0,85	0,88	39,2				
30	40	200L	96,8	7,4	2,9	2,8	0,1945	31	68	294	74,0	2960	92,0	93,0	93,0	0,77	0,84	0,87	53,5				
37	50	200L	119	7,6	2,7	2,7	0,2119	16	35	260	74,0	2960	93,2	93,5	93,6	0,76	0,84	0,87	65,6				
45	60	225S/M	145	8,5	2,4	2,9	0,4136	18	40	461	82,0	2970	93,0	93,7	93,7	0,82	0,88	0,90	77,0				
55	75	250S/M	177	8,9	2,6	3,4	0,4843	15	33	513	82,0	2965	93,0	94,0	94,0	0,85	0,89	0,91	91,8				
75	100	280S/M	241	7,7	2,2	2,9	1,18	51	112	841	83,0	2975	92,8	94,0	94,6	0,83	0,87	0,89	127				
90	125	280S/M	289	8,0	2,3	3,1	1,31	42	92	877	83,0	2980	93,8	95,0	94,9	0,78	0,84	0,87	157				
110	150	315S/M	353	8,5	2,3	3,2	1,40	20	44	1000	83,0	2981	94,0	95,1	95,1	0,77	0,85	0,88	190				
132	175	315S/M	424	8,2	2,2	2,8	1,62	32	70	1060	83,0	2978	94,0	95,0	95,3	0,82	0,88	0,89	225				
160	220	315S/M	512	7,8	2,2	2,5	1,97	33	73	1164	83,0	2985	94,5	95,4	95,4	0,85	0,89	0,90	269				
200	270	355M/L	640	7,2	1,8	2,6	4,56	70	154	1830	81,0	2985	93,2	94,7	95,1	0,89	0,91	0,92	328				
250	340	355M/L	800	7,8	1,7	2,5	5,39	65	143	1972	81,0	2985	95,0	95,7	95,7	0,87	0,91	0,92	407				
Optionals																							
1,5	2	90L	5,07	5,9	2,6	2,6	0,0016	12	26	17,5	62,0	2825	81,0	81,3	81,6	0,66	0,78	0,84	3,16				
75	100	250S/M	242	8,5	3,0	3,4	0,5132	10	22	570	82,0	2965	92,5	93,8	94,1	0,83	0,88	0,90	127				
110	150	280S/M	353	8,5	2,3	3,2	1,40	20	44	890	83,0	2981	94,0	95,1	95,1	0,77	0,85	0,88	190				
IV pole - 1500 rpm - 50 Hz																							
0,37	0,5	90S	2,42	6,2	2,1	2,7	0,0038	41	90	25,0	49,0	1460	76,5	77,0	77,2	0,55	0,69	0,77	0,898				
0,55	0,75	90S	3,62	6,4	2,2	2,6	0,0038	13	29	25,0	49,0	1450	77,5	79,5	79,5	0,56	0,70	0,78	1,28				
0,75	1	90S	4,94	6,2	2,2	2,6	0,0038	19	42	17,5	49,0	1450	78,0	80,0	80,0	0,59	0,72	0,78	1,73				
1,1	1,5	90L	7,30	6,5	2,1	2,6	0,0049	14	31	19,0	49,0	1440	81,0	81,8	81,8	0,60	0,72	0,79	2,46				
1,5	2	100L	9,95	7,5	2,8	3,3	0,0067	12	26	45,2	53,0	1440	82,5	83,5	83,5	0,61	0,73	0,80	3,18				
2,2	3	100L	14,7	7,6	3,3	3,3	0,0090	12	26	46,5	53,0	1435	83,0	85,0	85,0	0,57	0,71	0,79	4,73				
3	4	112M	19,8	7,0	2,2	2,7	0,0156	15	33	62,0	56,0	1450	85,0	86,0	86,0	0,61	0,74	0,80	6,19				
4	5,5	112M	26,5	7,4	2,5	3,0	0,0156	10	22	63,2	56,0	1445	86,0	87,0	87,3	0,60	0,72	0,80	8,17				
5,5	7,5	132S	36,0	7,3	1,9	3,0	0,0416	10	22	63,0	56,0	1460	88,0	88,1	88,1	0,69	0,81	0,86	10,5				
7,5	10	132M	48,9	7,8	2,1	3,0	0,0528	8	18	96,0	56,0	1465	88,7	89,0	89,0	0,68	0,79	0,84	14,5				
9,2	12,5	160M	60,2	5,6	2,3	2,3	0,0783	27	59	143	67,0	1460	88,5	90,0	90,0	0,70	0,80	0,84	17,4				
11	15	160M	71,7	6,0	2,5	2,6	0,0972	19	42	155	67,0	1465	90,0	90,5	90,6	0,68	0,78	0,83	21,1				
15	20	160L	98,2	6,1	2,5	2,6	0,1117	17	37	168	67,0	1460	90,0	90,8	90,9	0,66	0,77	0,83	28,7				
18,5	25	180M	120	8,0	2,9	2,9	0,1914	12	26	221	64,0	1470	91,0	92,2	92,4	0,65	0,76	0,82	34,9				
22	30	180L	143	7,5	2,7	2,9	0,1914	14	31	217	64,0	1470	91,2	92,4	92,5	0,65	0,77	0,82	41,6				
30	40	200L	194	7,0	2,5	2,6	0,3208	10	22	290	69,0	1475	92,2	92,6	92,6	0,67	0,78	0,83	56,3				
37	50	225S/M	239	7,2	2,2	2,7	0,6786	16	35	411	70,0	1480	92,6	93,6	93,7	0,76	0,84	0,87	65,2				
45	60	225S/M	291	7,4	2,5	2,8	0,8143	15	33	444	70,0	1480	93,5	93,8	93,8	0,75	0,83	0,86	80,5				
55	75	250S/M	356	7,2	2,5	2,8	1,05	17	37	530	70,0	1475	93,4	94,0	94,0	0,77	0,86	0,89	94,3				
75	100	280S/M	483	7,0	2,1	2,5	2,04	38	84	840	72,0	1484	93,5	94,0	94,4	0,79	0,85	0,87	132				
90	125	280S/M	579	7,8	2,4	2,6	2,74	25	55	934	72,0	1485	94,0	94,7	94,8	0,79	0,85	0,87	158				
110	150	280S/M	707	8,0	2,7	2,7	3,13	29	64	1065	72,0	1486	94,1	94,8	95,2	0,80	0,85	0,87	192				
110	150	315S/M	707	8,0	2,7	2,7	3,13	29	64	1100	72,0	1486	94,1	94,8	95,2	0,80	0,85	0,87	192				
132	175	315S/M	849	7,8	2,4	2,6	3,65	25	55	1190	72,0	1485	94,5	95,0	95,3	0,78	0,85	0,88	227				
150	200	315S/M	965	7,5	2,4	2,7	3,63	20	44	1005	72,0	1485	94,1	95,3	95,4	0,78	0,84	0,87	260				
160	220	315S/M	1029	8,5	2,6	2,7	3,79	20	44	1210	72,0	1485	94,1	95,3	95,4	0,75	0,83	0,86	281				
200	270	355M/L	1283	6,6	2,1	2,3	6,86	49	108	1817	79,0	1490	94,7	95,8	95,8	0,80	0,86	0,88	342				
220	300	355M/L	1411	7,0	2,1	2,4	6,86	38	84	1770	79,0	1490	94,8	95,8	95,8	0,77	0,84	0,86	385				
250	340	355M/L	1603	6,9	2,2	2,5	8,12	36	79	1921	79,0	1490	95,0	95,8	95,8	0,80	0,86	0,88	425				
315	430	355M/L	2020	6,5	2,2	2,4	9,92	42	92	2197	79,0	1490	95,0	95,9	95,9	0,79	0,86	0,89	529				
Optionals																							
0,55	0,75	90L	3,62	6,4	2,2	2,6	0,0038	13	29	25,0	49,0	1450	77,5	79,5	79,5	0,56	0,70	0,78	1,28				

Notes: 1) Insulation class "F" ΔT105K.
 2) The motors can also operate at a 60 Hz supply. The change in performance data can be obtained directly from the local WEG representative.
 3) The values shown in the electric tables are subjected to change without prior notice.
 4) Efficiency values are given according to IEC 60034-2-1. They are calculated according to indirect method, with stray load losses determined by measurement.

Ex db IIB T4 Gb

Output		380 V								415 V							
		Rated speed (rpm)	% of full load						Full load current In (A)	Rated speed (rpm)	% of full load						Full load current In (A)
			Efficiency			Power Factor					Efficiency			Power Factor			
kW	HP	50	75	100	50	75	100	50	75	100	50	75	100	50	75	100	
II pole - 3000 rpm - 50 Hz																	
0,75	1	2860	75,5	79,0	80,0	0,69	0,79	0,84	1,70	2890	74,5	79,0	80,0	0,62	0,72	0,80	1,63
1,1	1,5	2860	78,5	81,0	81,5	0,72	0,81	0,86	2,36	2880	77,5	81,0	81,5	0,63	0,75	0,82	2,25
1,5	2	2795	81,0	81,3	81,3	0,71	0,81	0,86	3,26	2840	80,8	81,6	82,0	0,61	0,75	0,82	3,10
2,2	3	2845	83,0	84,0	84,2	0,68	0,79	0,85	4,62	2870	82,0	84,0	84,2	0,57	0,71	0,80	4,49
3	4	2890	85,0	85,9	86,0	0,77	0,85	0,89	5,96	2910	84,0	85,6	86,1	0,69	0,78	0,85	5,70
4	5,5	2855	86,6	86,0	85,8	0,83	0,90	0,91	7,78	2880	85,3	85,9	86,3	0,74	0,83	0,87	7,41
5,5	7,5	2900	87,1	88,0	87,6	0,74	0,83	0,88	10,8	2915	85,6	87,6	88,0	0,63	0,76	0,83	10,5
7,5	10	2915	87,0	88,0	88,8	0,73	0,83	0,87	14,7	2930	85,5	87,0	88,8	0,62	0,75	0,82	14,2
9,2	12,5	2950	87,0	89,5	90,0	0,76	0,84	0,87	17,7	2960	86,0	89,5	90,0	0,69	0,80	0,84	16,7
11	15	2955	89,5	90,8	90,8	0,74	0,83	0,87	21,2	2965	88,5	90,8	90,8	0,66	0,77	0,83	20,3
15	20	2935	90,0	90,8	91,0	0,79	0,86	0,88	28,3	2950	89,0	90,8	91,0	0,71	0,80	0,86	26,4
18,5	25	2940	90,3	91,3	91,3	0,80	0,86	0,88	34,7	2950	90,0	91,3	91,3	0,72	0,82	0,85	32,8
22	30	2950	91,0	92,0	92,0	0,80	0,87	0,89	40,8	2960	90,5	92,0	92,0	0,73	0,83	0,86	38,7
30	40	2955	92,0	93,0	93,0	0,81	0,86	0,88	55,7	2965	92,0	93,0	93,0	0,74	0,82	0,86	52,2
37	50	2955	93,4	93,6	93,6	0,80	0,86	0,88	67,7	2965	93,0	93,5	93,6	0,72	0,82	0,86	63,9
45	60	2965	93,0	93,5	93,7	0,84	0,89	0,91	80,2	2970	92,5	93,7	93,7	0,80	0,87	0,89	75,1
55	75	2960	93,2	94,0	94,0	0,87	0,90	0,92	95,9	2970	92,8	94,0	94,0	0,80	0,86	0,88	91,5
75	100	2970	93,0	94,0	94,5	0,85	0,88	0,90	133	2975	92,5	94,0	94,5	0,81	0,86	0,88	124
90	125	2977	94,0	94,8	94,8	0,80	0,86	0,88	164	2981	93,5	94,8	94,8	0,75	0,83	0,86	154
110	150	2979	94,2	95,0	95,1	0,80	0,87	0,89	197	2983	93,8	94,8	95,1	0,74	0,83	0,87	185
132	175	2975	94,0	95,0	95,3	0,84	0,89	0,90	234	2980	93,7	95,0	95,3	0,80	0,87	0,89	217
160	220	2980	94,5	95,4	95,4	0,86	0,90	0,91	280	2985	94,5	95,4	95,4	0,83	0,88	0,89	262
200	270	2980	93,5	94,7	95,1	0,90	0,92	0,92	346	2985	93,0	94,6	95,1	0,88	0,90	0,91	320
250	340	2980	95,0	95,7	95,7	0,89	0,92	0,93	424	2985	95,0	95,7	95,7	0,86	0,91	0,92	392
Optionals																	
1,5	2	2795	81,0	81,3	81,3	0,71	0,81	0,86	3,26	2840	80,8	81,6	82,0	0,61	0,75	0,82	3,10
75	100	2960	92,7	93,8	94,1	0,85	0,89	0,91	133	2965	92,3	93,8	94,1	0,81	0,87	0,90	123
110	150	2979	94,2	95,0	95,1	0,80	0,87	0,89	197	2983	93,8	94,8	95,1	0,74	0,83	0,87	185
IV pole - 1500 rpm - 50 Hz																	
0,37	0,5	1455	76,5	77,0	77,2	0,59	0,72	0,80	0,910	1465	76,3	77,0	77,2	0,52	0,66	0,75	0,889
0,55	0,75	1445	78,2	79,3	79,3	0,60	0,73	0,80	1,32	1455	76,5	79,5	80,0	0,53	0,67	0,76	1,26
0,75	1	1445	79,1	79,9	79,6	0,64	0,76	0,81	1,77	1455	76,9	79,6	80,4	0,55	0,69	0,76	1,71
1,1	1,5	1432	81,9	81,8	81,5	0,65	0,75	0,81	2,53	1444	80,1	81,5	82,1	0,56	0,70	0,77	2,42
1,5	2	1430	83,0	83,5	83,5	0,65	0,76	0,82	3,28	1445	82,0	83,5	83,5	0,58	0,70	0,78	3,15
2,2	3	1430	84,0	85,0	85,0	0,62	0,75	0,81	4,85	1440	82,0	85,0	85,0	0,53	0,67	0,77	4,68
3	4	1445	85,5	86,0	86,0	0,65	0,77	0,83	6,31	1455	85,0	86,0	86,0	0,57	0,71	0,78	6,12
4	5,5	1435	86,8	87,0	87,0	0,67	0,78	0,83	8,38	1450	85,0	86,8	87,2	0,56	0,70	0,77	8,22
5,5	7,5	1455	88,6	88,0	87,7	0,74	0,84	0,88	10,9	1460	87,5	88,0	88,3	0,66	0,78	0,84	10,3
7,5	10	1460	89,0	88,7	88,7	0,75	0,83	0,87	14,8	1465	88,3	89,0	89,4	0,63	0,75	0,81	14,4
9,2	12,5	1455	89,0	90,0	90,0	0,74	0,82	0,85	18,1	1465	88,2	90,0	90,0	0,67	0,78	0,83	16,9
11	15	1460	90,0	90,5	90,5	0,72	0,81	0,85	21,7	1470	89,7	90,5	90,6	0,64	0,75	0,81	20,9
15	20	1455	90,0	90,5	90,6	0,70	0,80	0,85	29,6	1460	89,5	90,7	90,8	0,62	0,74	0,81	28,4
18,5	25	1465	91,2	92,2	92,4	0,70	0,80	0,84	35,9	1475	90,7	92,2	92,4	0,60	0,73	0,80	34,5
22	30	1465	91,8	92,4	92,5	0,70	0,80	0,84	42,8	1475	90,7	92,3	92,5	0,61	0,74	0,80	41,1
30	40	1470	93,0	93,1	92,4	0,72	0,81	0,85	58,0	1475	92,0	92,9	92,7	0,63	0,75	0,81	55,6
37	50	1480	93,0	93,6	93,6	0,80	0,86	0,88	68,0	1485	92,2	93,4	93,6	0,73	0,82	0,86	63,7
45	60	1475	93,6	93,8	93,8	0,78	0,85	0,87	83,8	1480	93,4	93,8	93,8	0,73	0,81	0,85	78,5
55	75	1475	93,4	94,0	94,0	0,80	0,88	0,90	98,4	1480	93,4	94,0	94,0	0,75	0,85	0,88	91,8
75	100	1482	93,7	94,0	94,0	0,81	0,86	0,87	139	1486	93,2	94,4	94,8	0,77	0,84	0,86	128
90	125	1485	94,0	94,7	94,6	0,81	0,87	0,89	162	1485	93,7	94,6	94,8	0,77	0,84	0,87	152
110	150	1484	94,3	94,8	95,1	0,82	0,86	0,87	202	1487	94,0	94,8	95,2	0,78	0,84	0,86	187
110	150	1484	94,3	94,8	95,1	0,82	0,86	0,87	202	1487	94,0	94,8	95,2	0,78	0,84	0,86	187
132	175	1480	94,5	95,0	95,2	0,80	0,86	0,89	237	1485	94,2	95,0	95,3	0,76	0,84	0,87	221
150	200	1480	94,4	95,3	95,3	0,80	0,86	0,88	271	1485	90,0	95,3	95,4	0,76	0,82	0,86	253
160	220	1480	94,4	95,3	95,3	0,77	0,85	0,87	293	1485	94,0	95,3	95,4	0,73	0,81	0,85	275
200	270	1485	94,9	95,6	95,7	0,83	0,87	0,89	357	1490	94,6	95,8	95,8	0,78	0,85	0,87	334
220	300	1490	95,0	95,8	95,8	0,80	0,86	0,87	401	1490	94,6	95,8	95,8	0,75	0,82	0,85	376
250	340	1485	95,0	95,8	95,8	0,82	0,87	0,89	443	1490	94,7	95,7	95,8	0,77	0,85	0,87	415
315	430	1485	95,0	95,9	95,9	0,83	0,87	0,89	557	1490	95,0	95,9	95,9	0,73	0,84	0,88	516
Optionals																	
0,55	0,75	1445	78,2	79,3	79,3	0,60	0,73	0,80	1,32	1455	76,5	79,5	80,0	0,53	0,67	0,76	1,26

W21Xdb Flameproof Motors - IE2 High Efficiency⁴⁾

Output kW / HP		Frame	Full Load Torque (Nm)	Locked Rotor Current I _L /I _n	Locked Rotor Torque T _L /T _n	Break-down Torque T _b /T _n	Inertia J (kgm ²)	Allowable locked rotor time (s)		Weight (kg)	Sound dB(A)	400 V						Full load current I _n (A)	
								Hot	Cold			% of full load			Power Factor				
												50	75	100	50	75	100		
II pole - 3000 rpm - 50 Hz																			
0,75	1	90S	2,49	7,8	3,0	3,4	0,0012	20	44	30,5	62,0	2880	75,0	79,0	80,0	0,65	0,75	0,82	1,65
1,1	1,5	90S	3,66	7,6	2,9	2,9	0,0014	14	31	30,5	62,0	2870	78,0	81,0	81,5	0,67	0,78	0,84	2,28
1,5	2	90S	5,07	5,9	2,6	2,6	0,0016	12	26	17,5	62,0	2825	81,0	81,3	81,6	0,66	0,78	0,84	3,16
2,2	3	90L	7,36	7,8	3,5	3,4	0,0023	10	22	36,0	62,0	2855	83,0	84,0	84,2	0,63	0,76	0,83	4,47
3	4	100L	9,88	8,5	3,0	3,8	0,0059	9	20	42,0	67,0	2900	84,5	85,8	86,0	0,73	0,80	0,86	5,85
4	5,5	112M	13,3	6,8	2,3	2,9	0,0066	16	35	60,0	64,0	2870	86,0	86,0	86,0	0,78	0,86	0,89	7,54
5,5	7,5	132S	18,1	6,8	2,2	3,0	0,0162	17	37	85,4	67,0	2910	86,5	88,0	88,0	0,68	0,79	0,85	10,6
7,5	10	132S	24,5	7,3	2,5	3,0	0,0198	10	22	81,3	67,0	2925	86,5	88,0	88,8	0,67	0,79	0,85	14,2
9,2	12,5	160M	29,8	8,5	2,5	3,2	0,0452	15	33	145	70,0	2955	86,5	89,5	90,0	0,72	0,82	0,86	17,0
11	15	160M	35,5	9,0	2,7	3,7	0,0509	14	31	151	70,0	2960	89,0	90,8	90,8	0,70	0,80	0,85	20,6
15	20	160M	48,7	7,8	2,5	3,2	0,0509	10	22	152	70,0	2945	89,5	90,8	91,0	0,74	0,83	0,87	27,1
18,5	25	160L	60,0	8,2	2,6	3,3	0,0622	10	22	169	70,0	2945	90,3	91,3	91,3	0,75	0,84	0,87	33,3
22	30	180M	71,1	8,5	2,6	3,3	0,1149	13	29	218	70,0	2955	91,0	92,0	92,0	0,76	0,85	0,88	39,2
30	40	200L	96,8	7,4	2,9	2,8	0,1945	31	68	294	74,0	2960	92,0	93,0	93,0	0,77	0,84	0,87	53,5
37	50	200L	119	7,6	2,7	2,7	0,2119	16	35	260	74,0	2960	93,2	93,5	93,6	0,76	0,84	0,87	65,6
45	60	225S/M	145	8,5	2,4	2,9	0,4136	18	40	461	82,0	2970	93,0	93,7	93,7	0,82	0,88	0,90	77,0
55	75	250S/M	177	8,9	2,6	3,4	0,4843	15	33	513	82,0	2965	93,0	94,0	94,0	0,85	0,89	0,91	91,8
75	100	280S/M	241	7,7	2,2	2,9	1,18	51	112	841	83,0	2975	92,8	94,0	94,6	0,83	0,87	0,89	127
90	125	280S/M	289	8,0	2,3	3,1	1,31	42	92	877	83,0	2980	93,8	95,0	94,9	0,78	0,84	0,87	157
110	150	315S/M	353	8,5	2,3	3,2	1,40	20	44	1000	83,0	2981	94,0	95,1	95,1	0,77	0,85	0,88	190
132	175	315S/M	424	8,2	2,2	2,8	1,62	32	70	1060	83,0	2978	94,0	95,0	95,3	0,82	0,88	0,89	225
160	220	315S/M	512	7,8	2,2	2,5	1,97	33	73	1164	83,0	2985	94,5	95,4	95,4	0,85	0,89	0,90	269
200	270	355M/L	640	7,2	1,8	2,6	4,56	70	154	1830	81,0	2985	93,2	94,7	95,1	0,89	0,91	0,92	328
250	340	355M/L	800	7,8	1,7	2,5	5,39	65	143	1972	81,0	2985	95,0	95,7	95,7	0,87	0,91	0,92	407
Optionals																			
1,5	2	90L	5,07	5,9	2,6	2,6	0,0016	12	26	17,5	62,0	2825	81,0	81,3	81,6	0,66	0,78	0,84	3,16
7,5	10	250S/M	242	8,5	3,0	3,4	0,5132	10	22	570	82,0	2965	92,5	93,8	94,1	0,83	0,88	0,90	127
110	150	280S/M	353	8,5	2,3	3,2	1,40	20	44	890	83,0	2981	94,0	95,1	95,1	0,77	0,85	0,88	190
IV pole - 1500 rpm - 50 Hz																			
0,37	0,5	90S	2,42	6,2	2,1	2,7	0,0038	41	90	25,0	49,0	1460	76,5	77,0	77,2	0,55	0,69	0,77	0,898
0,55	0,75	90S	3,62	6,4	2,2	2,6	0,0038	13	29	25,0	49,0	1450	77,5	79,5	79,5	0,56	0,70	0,78	1,28
0,75	1	90S	4,94	6,2	2,2	2,6	0,0038	19	42	17,5	49,0	1450	78,0	80,0	80,0	0,59	0,72	0,78	1,73
1,1	1,5	90L	7,30	6,5	2,1	2,6	0,0049	14	31	19,0	49,0	1440	81,0	81,8	81,8	0,60	0,72	0,79	2,46
1,5	2	100L	9,95	7,5	2,8	3,3	0,0067	12	26	45,2	53,0	1440	82,5	83,5	83,5	0,61	0,73	0,80	3,18
2,2	3	100L	14,7	7,6	3,3	3,3	0,0090	12	26	46,5	53,0	1435	83,0	85,0	85,0	0,57	0,71	0,79	4,73
3	4	112M	19,8	7,0	2,2	2,7	0,0156	15	33	62,0	56,0	1450	85,0	86,0	86,0	0,61	0,74	0,80	6,19
4	5,5	112M	26,5	7,4	2,5	3,0	0,0156	10	22	63,2	56,0	1445	86,0	87,0	87,3	0,60	0,72	0,80	8,17
5,5	7,5	132S	36,0	7,3	1,9	3,0	0,0416	10	22	63,0	56,0	1460	88,0	88,1	88,1	0,69	0,81	0,86	10,5
7,5	10	132M	48,9	7,8	2,1	3,0	0,0528	8	18	96,0	56,0	1465	88,7	89,0	89,0	0,68	0,79	0,84	14,5
9,2	12,5	160M	60,2	5,6	2,3	2,3	0,0783	27	59	143	67,0	1460	88,5	90,0	90,0	0,70	0,80	0,84	17,4
11	15	160M	71,7	6,0	2,5	2,6	0,0972	19	42	155	67,0	1465	90,0	90,5	90,6	0,68	0,78	0,83	21,1
15	20	160L	98,2	6,1	2,5	2,6	0,1117	17	37	168	67,0	1460	90,0	90,8	90,9	0,66	0,77	0,83	28,7
18,5	25	180M	120	8,0	2,9	2,9	0,1914	12	26	221	64,0	1470	91,0	92,2	92,4	0,65	0,76	0,82	34,9
22	30	180L	143	7,5	2,7	2,9	0,1914	14	31	217	64,0	1470	91,2	92,4	92,5	0,65	0,77	0,82	41,6
30	40	200L	194	7,0	2,5	2,6	0,3208	10	22	290	69,0	1475	92,2	92,6	92,6	0,67	0,78	0,83	56,3
37	50	225S/M	239	7,2	2,2	2,7	0,6786	16	35	411	70,0	1480	92,6	93,6	93,7	0,76	0,84	0,87	65,2
45	60	225S/M	291	7,4	2,5	2,8	0,8143	15	33	444	70,0	1480	93,5	93,8	93,8	0,75	0,83	0,86	80,5
55	75	250S/M	356	7,2	2,5	2,8	1,05	17	37	530	70,0	1475	93,4	94,0	94,0	0,77	0,86	0,89	94,3
75	100	280S/M	483	7,0	2,1	2,5	2,04	38	84	840	72,0	1484	93,5	94,0	94,4	0,79	0,85	0,87	132
90	125	280S/M	579	7,8	2,4	2,6	2,74	25	55	934	72,0	1485	94,0	94,7	94,8	0,79	0,85	0,87	158
110	150	280S/M	707	8,0	2,7	2,7	3,13	29	64	1065	72,0	1486	94,1	94,8	95,2	0,80	0,85	0,87	192
110	150	315S/M	707	8,0	2,7	2,7	3,13	29	64	1100	72,0	1486	94,1	94,8	95,2	0,80	0,85	0,87	192
132	175	315S/M	849	7,8	2,4	2,6	3,65	25	55	1190	72,0	1485	94,5	95,0	95,3	0,78	0,85	0,88	227
150	200	315S/M	965	7,5	2,4	2,7	3,63	20	44	1005	72,0	1485	94,1	95,3	95,4	0,78	0,84	0,87	260
160	220	315S/M	1029	8,5	2,6	2,7	3,79	20	44	1210	72,0	1485	94,1	95,3	95,4	0,75	0,83	0,86	281

Notes: 1) Insulation class "F" ΔT105K.

2) The motors can also operate at a 60 Hz supply. The change in performance data can be obtained directly from the local WEG representative.

3) The values shown in the electric tables are subjected to change without prior notice.

4) Efficiency values are given according to IEC 60034-2-1. They are calculated according to indirect method, with stray load losses determined by measurement.

Ex db IIB T4 Gb

Output		380 V								415 V							
		Rated speed (rpm)	% of full load						Full load current In (A)	Rated speed (rpm)	% of full load						Full load current In (A)
			Efficiency			Power Factor					Efficiency			Power Factor			
kW	HP	50	75	100	50	75	100	50	75	100	50	75	100	50	75	100	
II pole - 3000 rpm - 50 Hz																	
0,75	1	2860	75,5	79,0	80,0	0,69	0,79	0,84	1,70	2890	74,5	79,0	80,0	0,62	0,72	0,80	1,63
1,1	1,5	2860	78,5	81,0	81,5	0,72	0,81	0,86	2,36	2880	77,5	81,0	81,5	0,63	0,75	0,82	2,25
1,5	2	2795	81,0	81,3	81,3	0,71	0,81	0,86	3,26	2840	80,8	81,6	82,0	0,61	0,75	0,82	3,10
2,2	3	2845	83,0	84,0	84,2	0,68	0,79	0,85	4,62	2870	82,0	84,0	84,2	0,57	0,71	0,80	4,49
3	4	2890	85,0	85,9	86,0	0,77	0,85	0,89	5,96	2910	84,0	85,6	86,1	0,69	0,78	0,85	5,70
4	5,5	2855	86,6	86,0	85,8	0,83	0,90	0,91	7,78	2880	85,3	85,9	86,3	0,74	0,83	0,87	7,41
5,5	7,5	2900	87,1	88,0	87,6	0,74	0,83	0,88	10,8	2915	85,6	87,6	88,0	0,63	0,76	0,83	10,5
7,5	10	2915	87,0	88,0	88,8	0,73	0,83	0,87	14,7	2930	85,5	87,0	88,8	0,62	0,75	0,82	14,2
9,2	12,5	2950	87,0	89,5	90,0	0,76	0,84	0,87	17,7	2960	86,0	89,5	90,0	0,69	0,80	0,84	16,7
11	15	2955	89,5	90,8	90,8	0,74	0,83	0,87	21,2	2965	88,5	90,8	90,8	0,66	0,77	0,83	20,3
15	20	2935	90,0	90,8	91,0	0,79	0,86	0,88	28,3	2950	89,0	90,8	91,0	0,71	0,80	0,86	26,4
18,5	25	2940	90,3	91,3	91,3	0,80	0,86	0,88	34,7	2950	90,0	91,3	91,3	0,72	0,82	0,85	32,8
22	30	2950	91,0	92,0	92,0	0,80	0,87	0,89	40,8	2960	90,5	92,0	92,0	0,73	0,83	0,86	38,7
30	40	2955	92,0	93,0	93,0	0,81	0,86	0,88	55,7	2965	92,0	93,0	93,0	0,74	0,82	0,86	52,2
37	50	2955	93,4	93,6	93,6	0,80	0,86	0,88	67,7	2965	93,0	93,5	93,6	0,72	0,82	0,86	63,9
45	60	2965	93,0	93,5	93,7	0,84	0,89	0,91	80,2	2970	92,5	93,7	93,7	0,80	0,87	0,89	75,1
55	75	2960	93,2	94,0	94,0	0,87	0,90	0,92	95,9	2970	92,8	94,0	94,0	0,80	0,86	0,88	91,5
75	100	2970	93,0	94,0	94,5	0,85	0,88	0,90	133	2975	92,5	94,0	94,5	0,81	0,86	0,88	124
90	125	2977	94,0	94,8	94,8	0,80	0,86	0,88	164	2981	93,5	94,8	94,8	0,75	0,83	0,86	154
110	150	2979	94,2	95,0	95,1	0,80	0,87	0,89	197	2983	93,8	94,8	95,1	0,74	0,83	0,87	185
132	175	2975	94,0	95,0	95,3	0,84	0,89	0,90	234	2980	93,7	95,0	95,3	0,80	0,87	0,89	217
160	220	2980	94,5	95,4	95,4	0,86	0,90	0,91	280	2985	94,5	95,4	95,4	0,83	0,88	0,89	262
200	270	2980	93,5	94,7	95,1	0,90	0,92	0,92	346	2985	93,0	94,6	95,1	0,88	0,90	0,91	320
250	340	2980	95,0	95,7	95,7	0,89	0,92	0,93	424	2985	95,0	95,7	95,7	0,86	0,91	0,92	392
Optionals																	
1,5	2	2795	81,0	81,3	81,3	0,71	0,81	0,86	3,26	2840	80,8	81,6	82,0	0,61	0,75	0,82	3,10
75	100	2960	92,7	93,8	94,1	0,85	0,89	0,91	133	2965	92,3	93,8	94,1	0,81	0,87	0,90	123
110	150	2979	94,2	95,0	95,1	0,80	0,87	0,89	197	2983	93,8	94,8	95,1	0,74	0,83	0,87	185
IV pole - 1500 rpm - 50 Hz																	
0,37	0,5	1455	76,5	77,0	77,2	0,59	0,72	0,80	0,910	1465	76,3	77,0	77,2	0,52	0,66	0,75	0,889
0,55	0,75	1445	78,2	79,3	79,3	0,60	0,73	0,80	1,32	1455	76,5	79,5	80,0	0,53	0,67	0,76	1,26
0,75	1	1445	79,1	79,9	79,6	0,64	0,76	0,81	1,77	1455	76,9	79,6	80,4	0,55	0,69	0,76	1,71
1,1	1,5	1432	81,9	81,8	81,5	0,65	0,75	0,81	2,53	1444	80,1	81,5	82,1	0,56	0,70	0,77	2,42
1,5	2	1430	83,0	83,5	83,5	0,65	0,76	0,82	3,28	1445	82,0	83,5	83,5	0,58	0,70	0,78	3,15
2,2	3	1430	84,0	85,0	85,0	0,62	0,75	0,81	4,85	1440	82,0	85,0	85,0	0,53	0,67	0,77	4,68
3	4	1445	85,5	86,0	86,0	0,65	0,77	0,83	6,31	1455	85,0	86,0	86,0	0,57	0,71	0,78	6,12
4	5,5	1435	86,8	87,0	87,0	0,67	0,78	0,83	8,38	1450	85,0	86,8	87,2	0,56	0,70	0,77	8,22
5,5	7,5	1455	88,6	88,0	87,7	0,74	0,84	0,88	10,9	1460	87,5	88,0	88,3	0,66	0,78	0,84	10,3
7,5	10	1460	89,0	88,7	88,7	0,75	0,83	0,87	14,8	1465	88,3	89,0	89,4	0,63	0,75	0,81	14,4
9,2	12,5	1455	89,0	90,0	90,0	0,74	0,82	0,85	18,1	1465	88,2	90,0	90,0	0,67	0,78	0,83	16,9
11	15	1460	90,0	90,5	90,5	0,72	0,81	0,85	21,7	1470	89,7	90,5	90,6	0,64	0,75	0,81	20,9
15	20	1455	90,0	90,5	90,6	0,70	0,80	0,85	29,6	1460	89,5	90,7	90,8	0,62	0,74	0,81	28,4
18,5	25	1465	91,2	92,2	92,4	0,70	0,80	0,84	35,9	1475	90,7	92,2	92,4	0,60	0,73	0,80	34,5
22	30	1465	91,8	92,4	92,5	0,70	0,80	0,84	42,8	1475	90,7	92,3	92,5	0,61	0,74	0,80	41,1
30	40	1470	93,0	93,1	92,4	0,72	0,81	0,85	58,0	1475	92,0	92,9	92,7	0,63	0,75	0,81	55,6
37	50	1480	93,0	93,6	93,6	0,80	0,86	0,88	68,0	1485	92,2	93,4	93,6	0,73	0,82	0,86	63,7
45	60	1475	93,6	93,8	93,8	0,78	0,85	0,87	83,8	1480	93,4	93,8	93,8	0,73	0,81	0,85	78,5
55	75	1475	93,4	94,0	94,0	0,80	0,88	0,90	98,4	1480	93,4	94,0	94,0	0,75	0,85	0,88	91,8
75	100	1482	93,7	94,0	94,0	0,81	0,86	0,87	139	1486	93,2	94,4	94,8	0,77	0,84	0,86	128
90	125	1485	94,0	94,7	94,6	0,81	0,87	0,89	162	1485	93,7	94,6	94,8	0,77	0,84	0,87	152
110	150	1484	94,3	94,8	95,1	0,82	0,86	0,87	202	1487	94,0	94,8	95,2	0,78	0,84	0,86	187
110	150	1484	94,3	94,8	95,1	0,82	0,86	0,87	202	1487	94,0	94,8	95,2	0,78	0,84	0,86	187
132	175	1480	94,5	95,0	95,2	0,80	0,86	0,89	237	1485	94,2	95,0	95,3	0,76	0,84	0,87	221
150	200	1480	94,4	95,3	95,3	0,80	0,86	0,88	271	1485	90,0	95,3	95,4	0,76	0,82	0,86	253
160	220	1480	94,4	95,3	95,3	0,77	0,85	0,87	293	1485	94,0	95,3	95,4	0,73	0,81	0,85	275

Mechanical Data

Dimensions in mm

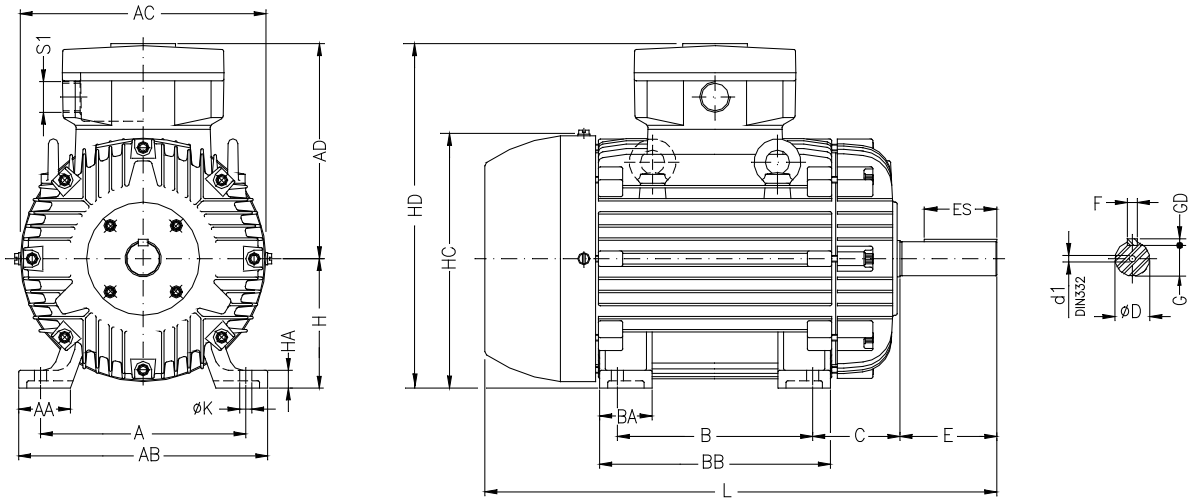

Frame	A	AA	AB	AC	AD	B	BA	BB	C	H	HA	HC	HD
90S	140	38	164	179	-	100	42	131	56	90	12	182	-
90L						125		156					
100L	160	44	188	199	224	140	50	173	63	100	15	200	282
112M	190	48	220	223	207			177	70	112	17	237	
132S	216	51	248	270	271	178	55	188	89	132	19,5	282	327
132M								226					
160M	254	64	308	312	322	210	65	254	108	160	22	315	368
160L						254		298					
180M	279	80	350	358	342	241	75	294	121	180	28	367	429
180L						279		332					
200L	318	82	385	399	370	305	85	370	133	200	30	403	474
225S/M ¹⁾	356	80	436	472	413	286/311	105	391	149	225	34	475	546
225S/M													
225S/M ¹⁾	406	100	506	610	551	311/349	138	445	168	250	42	500	571
250S/M													
225S/M ¹⁾	457	557	610	573	406/457	152	558	216	315	52	640	730	
280S/M													
225S/M ¹⁾	508	120	628	672	560/630	200	760	254	355	50	755	864	
315S/M													
225S/M ¹⁾	610	140	750	780	672	560/630	200	760	254	355	50	755	864
355M/L													

Frame	K	L	S1	D	D1	E	ES	F	G	GD
90S	10	314	M25x1.5	24j6	DM8	50	36	8	20	7
90L		341		28j6						
100L	12	384	M32x1.5	28j6	DM10	60	45	10	33	8
112M		394								
132S	14,5	451	2xM40x1.5	38k6	DM12	80	63	14	42,5	9
132M		489								
160M	14,5	598	2xM40x1.5	42k6	DM16	110	80	12	37	8
160L		652								
180M	18,5	664	2xM40x1.5	48k6	DM16	110	80	14	42,5	9
180L		702								
200L	18,5	767	2xM50x1.5	55m6	DM16	110	80	16	49	10
225S/M ¹⁾		817								
225S/M	24	849	2xM50x1.5	60m6	DM20	140	125	18	53	11
250S/M ¹⁾										
250S/M	24	923	2xM63x1.5	65m6	DM20	140	125	18	58	11
280S/M ¹⁾										
280S/M	28	1036	2xM63x1.5	75m6	DM20	140	125	20	67,5	12
315S/M ¹⁾										
315S/M	28	1126	2xM63x1.5	65m6	DM20	140	125	18	58	11
315S/M										
315S/M	28	1156	2xM63x1.5	80m6	DM20	170	160	22	71	14
355M/L ¹⁾										
355M/L	28	1399	2xM63x1.5	75m6	DM20	140	125	20	67,5	12
355M/L										
355M/L	28	1469	2xM63x1.5	100m6	DM24	210	200	28	90	16
355M/L										

Note: 1) Dimension applicable to 2 pole motors.

Flange Mounted Motors

Dimensions in mm

“FF” Flange

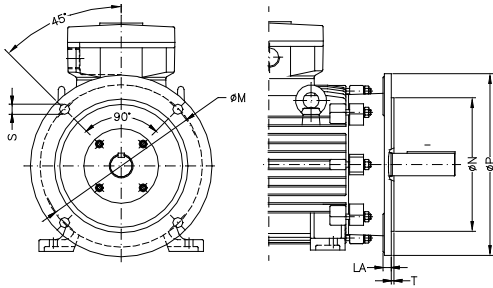

Frame	Flange	LA	M	N	P	S	T	α	N° of holes
90	FF-165	8	165	130	200	12	3,5	45°	4
100	FF-215	11	215	180	250	15	4		
112		12	265	230	300				
160	FF-300	13	300	250	350	19	5		
180		14							
200	FF-350	18	350	300	400	24	6	22,5°	8
225	FF-400		400	350	450				
250	FF-500	20	500	450	550				
280		18							
315	FF-600	22	600	550	660				
355	FF-740		740	680	800				

“NEMA C” Flange

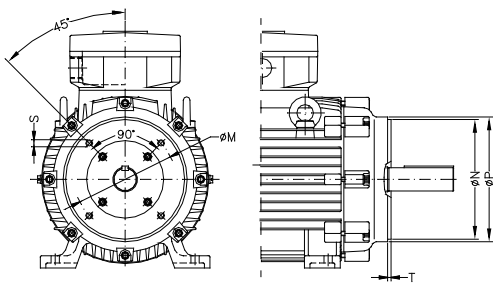

Frame	“NEMA C” Flange							α	N° of holes
	Flange	LA	M	N	P	S	T		
90	FC-149	15	149,2	114,3	165	UNC 3/8"x16	4	45°	4
100		12							
112	FC-184	13,5	184,2	215,9	225	UNC 1/2"x13	6,3		
132		15,5							
160	26								
180	FC-228	20	228,6	266,7	280	UNC 5/8"x11	6,3		
200		25							
225	FC-279	25	279,4	317,5	395				
250	FC-355		355,6	406,4	455				
280		368,3							
315	FC-368	419,1							

“C-DIN” Flange

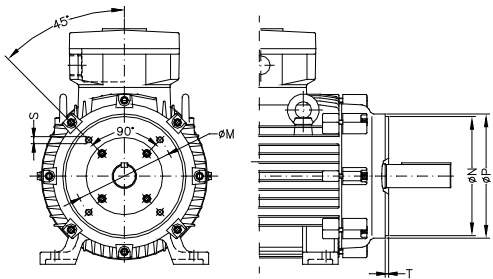

Frame	Flange	M	N	P	S	T	α	N° of holes
90	C-140	115	95	140	M8	3	45°	4
100	C-160	130	110	165		3,5		
112				160				
132	C-200	165	130	200	M10			

For WEG's worldwide
operations visit our website



www.weg.net



 +55 47 3276.4000

 motores@weg.net

 Jaraguá do Sul - SC - Brazil

Cod: 50100581 | Rev: 01 | Date (m/y): 12/2020.

The values shown are subject to change without prior notice.

The information contained is reference values.